GLIDING



AND

SOARING

by

**PERCIVAL WHITE
AND MAT WHITE**

Gliding and Soaring

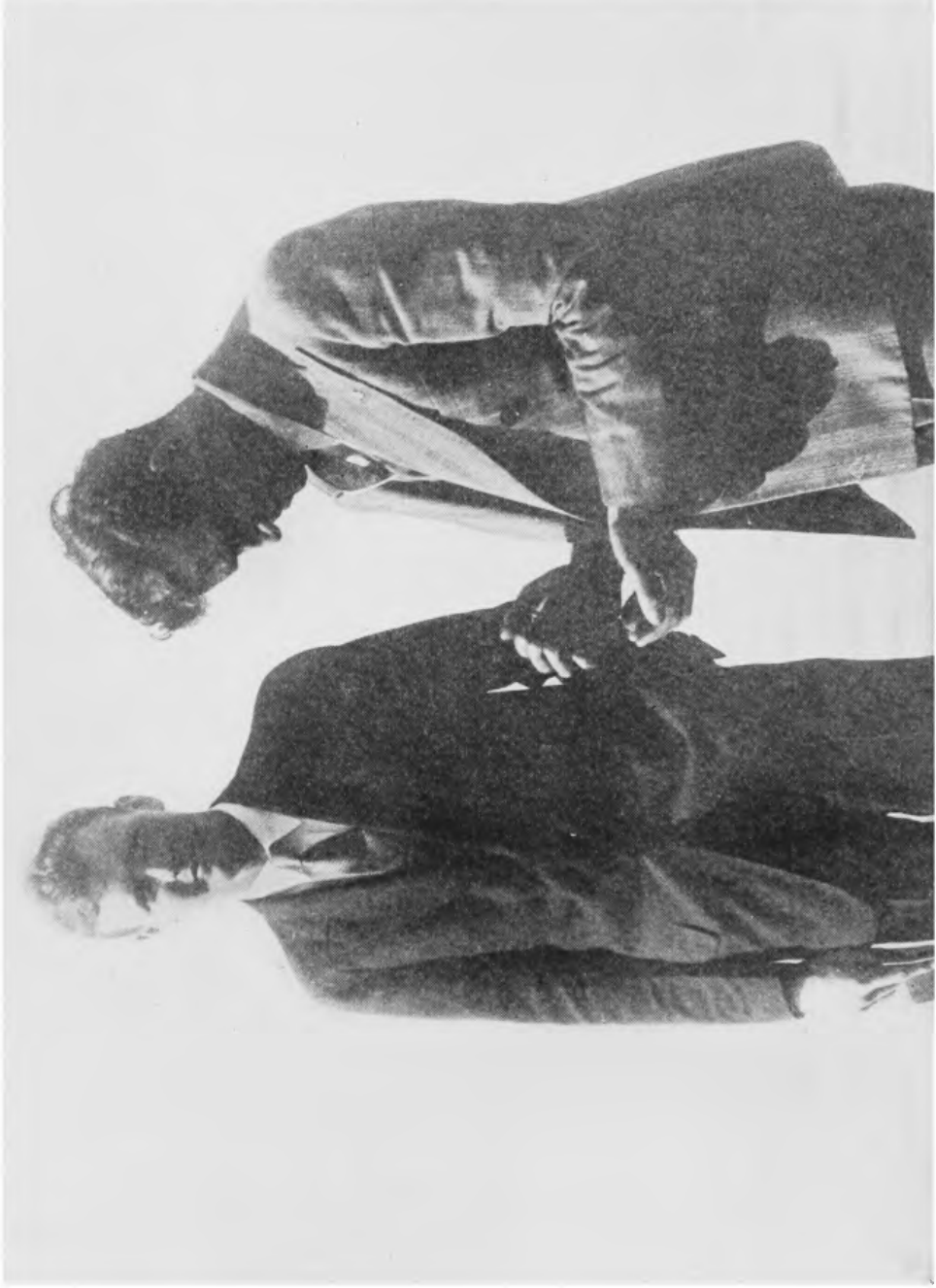

FRONTISPIECE.—Col. Charles A. Lindbergh and William H. Bowlus, two men who have done much to stimulate interest in gliding in this country.

GLIDING AND SOARING

An Introduction to Motorless Flight

BY
PERCIVAL WHITE

AND
MAT WHITE

WHITTLESEY HOUSE
MCGRAW-HILL BOOK COMPANY, INC.
NEW YORK · 1931

Copyright, 1931, by the
McGraw-Hill Book Company, Inc.
All rights reserved. This book, or parts thereof
may not be reproduced in any form without
permission of the publishers.

FIRST EDITION

Published by
WHITTLESEY HOUSE
A Division of the
McGraw-Hill Book Company, Inc.
NEW YORK

Printed in the United States of America by
The Maple Press Company, York, Pa.

PREFACE

GLIDING is one of the great developments in aviation. It is not only the door through which the layman may enter the field of flying, not only a subject for the attention of motored-plane pilots and manufacturers; but it is, in itself, an incomparable sport. Every one who would be a vital member of this modern age should be familiar with that new, silent bird, the glider, and should know something about how it flies.

“Gliding and Soaring” is intended to be used as an elementary text. In order that it may serve this purpose effectively, the authors have attempted to give it two qualities: conciseness and clearness. Conciseness is essential to such a book, to assist the reader in acquiring a comprehensive view of the subject matter in a conveniently short time. For the sake of conciseness, a compact style of writing has been aimed at; and a good deal of rather extraneous material, interesting as it is, such as the anecdotes appearing in the newspapers, have been omitted. In order to obtain clearness, the book has been illustrated profusely by diagrams and photographs, and all flying terms which might be new to the reader have been carefully defined.

The book, is addressed to several groups of people. In the first place, it should be of interest to boys who have not yet begun to fly. The style and subject matter of the book have been adapted primarily to their needs.

In the second place, “Gliding and Soaring” is addressed to those would-be motor pilots who intend to learn gliding as a step in their aeronautical training. Such persons

GLIDING AND SOARING

may desire to build their own gliders. These men especially will find the chapters on glider construction useful.

Third, the pilots and manufacturers of airplanes have not been unaffected by advances in the science of gliding. The editor of an aviation magazine recently said that a group of aviation men cannot talk together for 5 minutes without allowing the subject of gliding to creep into the conversation. The pilot of a motored plane cannot be completely up-to-date, unless he is aware of the progress being made by glider pilots. The airplane manufacturer may find himself in a less strategic position if he neither produces gliders nor studies the recent progress in this branch of aviation.

Fourth, designers, engineers, and scientists have need of an acquaintance with the recent developments in gliding. Many of them have already predicted that the next step in aviation will probably be the designing of a combination airplane-glider, which will bring together the good qualities of each type of ship. But, in order that the engineer may draw conclusions concerning the glider and build machines in accordance with those conclusions, he must know a great deal of the theory and the practice of gliding. It is hoped that this book will supply at least an elementary knowledge.

Finally, many people who intend neither to learn to glide at present, nor to use their knowledge of gliders for business or scientific purposes, are eager for some information about so timely a subject. Gliding, in other words, has become a subject of intense popular interest.

“Gliding and Soaring” should be considered by those people who are actually learning to glide as merely supplemental to a course in practical training. But the student pilot may well, before making his first flight, learn something of the principles of aerodynamics and of the way he must handle the controls when he is in the air. One good way to obtain such information is by reading a book which is a unified treatment of the entire subject.

PREFACE

The chapters in "Gliding and Soaring" have been so arranged that it may best serve as a supplement to actual flight training. Part One is introductory. The second chapter in this part (How You Are Taught to Glide) is a synopsis of the subject matter covered in the remainder of the book. Such a synopsis gives the reader, at the outset of his study, a preliminary view of the entire subject. Part Two deals with the theory of gliding. A grasp of theory is necessary to the understanding of the principles of practical flight. Some theory should be studied before the student pilot goes into the air. Part Three is a discussion of the actual control movements which the pilot must make in order to take off, glide downward, land, and perform other simple maneuvers. Part Four explains the way in which wind currents may be utilized in order to soar. When the student has learned something of the principles and the practice of gliding, he may become interested in learning to design and build planes, a subject taken up in Part Five. Part Six is devoted to experimentation.

NEW YORK CITY
May, 1931.

PERCIVAL WHITE.
MAT WHITE.

ACKNOWLEDGMENTS

The authors wish to acknowledge their indebtedness to the following persons for their help in supplying photographs and information and for various other assistance in the preparation of the work.

Donald F. Walker, National Glider Association, Inc.; Harry G. Smith, All-American Glider Co., Dearborn, Mich.; National Advisory Committee for Aeronautics, Navy Building, Washington, D. C.; Marion K. Nolan, of Percival White, Inc., New York City; Dr. Adolph Rebensburg, of Percival White, Inc., New York City; John Burbank, Sea Cliff, N. Y.; Robert B. Evans, Evans Appliance Co., Detroit, Mich.; M. F. Stoughton, National Glider Association, Inc., Detroit, Mich.; J. P. Schroeter, Milwaukee, Wis.; Major Vergne Chappelle, American Motorless Aviation Corporation, New York City; Charles G. Wheeler, Topsham, Me.; Mr. Glenn H. Curtiss, Country Club Estates, Fla.; Miss Polly Harris, Cambridge, Mass.; C. J. Germaine, New York City; William Van Dusen, Aero Club of San Diego, San Diego, Calif.; Lieut. J. Thoret, Aerodrome du Mt. Blanc, France; Pat Murphy, Detroit Aircraft Corporation, Detroit, Mich.; Paul E. Garber, Smithsonian Institution, Washington, D. C.; Prof. Felix W. Pawlowski, University of Michigan, Ann Arbor, Mich.; James D. Redding, University of Michigan, Ann Arbor, Mich.; R. J. Robertson, Alameda, Calif.; W. H. Tomer, Garden City, N. Y.; J. Don Alexander, Alexander Aircraft Co., Colorado Springs, Colo.; W. Hawley Bowlus, San Diego, Calif.; Curtiss Flying Service, Garden City, N. Y.; United States Weather Bureau, Washington, D. C.; *Muenchener Illustrierte Zeitung*, Munich, Germany; George M. Pynchon, Jr., New York City; Lieut. R. S. Barnaby, Bureau of Aeronautics, Washington, D. C.; C. H. Snyder, Motor Gliders, Inc., Dayton, Ohio; Capt. H. J. Loftus Price, New York City; Theodore J. Marx, Salt Lake City, Utah; Department of Commerce, Aeronautics Branch, Washington, D. C.; William A. Georgsen, Hollywood, Calif.; A. V. Verville, Verville Aircraft Co., Detroit, Mich.; Carl B. Squier, Lockheed Aircraft Corp., Burbank, Calif.; H. R. McClin-tock, Russell Parachute Co., San Diego, Calif., Earle H. Smith, American Eagle Aircraft Corp., Kansas City, Kans.; William S. Thomas, Fairchild Airplane Manufacturing Corp., Farmingdale, N. Y.; B. D. Spofford, Waco Aircraft Co.; Troy, Ohio; Minton M. Warren, Curtiss Robertson Airplane Manufacturing Co., Anglum, Mo.; F. B. Collins, Boeing Airplane Company, Seattle, Wash.; R. P. Whitman, Consolidated Aircraft Corp., Buffalo, N. Y.; G. R. Coats,

GLIDING AND SOARING

Berline-Joyce Aircraft Corp., Baltimore, Md.; H. Newton Whittelsey, Whittelsey Manufacturing Co., Inc., Bridgeport, Conn.; N. U. Clements, Curtiss Aeroplane and Motor Co., Garden City, N. Y.; U. E. Thompson, Thompson Bros. Balloon and Parachute Co.; Aurora, Ill.; L. W. Ashton, Bellanca Aircraft Corp., New Castle, Del.; Marvin E. Nulsen, Ryan Aircraft Corp., Robertson, Mo.; F. L. Black, Ford Motor Co., Dearborn, Mich.; Alexander Klemm, New York University, New York City; Charles S. Leonard, Leonard Motorless Aircraft Co., Grand Rapids, Mich.; E. A. Johnson, Johnson Aircraft and Supply Co., Dayton, Ohio; Floyce D. Smith, Fokker Aircraft Corp., New York City, H. C. Blake, Springfield, Ohio; Glenn D. Angle, Le Blond Aircraft Engine Corp., Cincinnati, Ohio; H. R. Hart, A. G. Spalding & Bros., New York City; *Science and Invention*, 381 Fourth Avenue, New York City.

CONTENTS

PREFACE vii

ACKNOWLEDGMENTS xi

Part One

INTRODUCTION

I. WHY YOU SHOULD LEARN TO GLIDE 3

II. HOW YOU ARE TAUGHT TO GLIDE 10

III. THE HISTORY OF GLIDERS 25

IV. THE QUALIFICATIONS OF A PILOT 36

Part Two

GROUND INSTRUCTION

V. THE WIND AND THE WEATHER 43

VI. KITES AND WHAT THEY TEACH ABOUT GLIDING 54

VII. WHAT THE GLIDER LOOKS LIKE 59

VIII. WHY THE GLIDER STAYS IN THE AIR 68

IX. HOW THE CONTROLS WORK 74

Part Three

GLIDING

X. TAKE-OFFS 81

XI. STRAIGHT FLIGHT 92

XII. STALLS 101

GLIDING AND SOARING

XIII.	LANDINGS	106
XIV.	TURNS	114
XV.	WATER GLIDERS	122

Part Four

SOARING

XVI.	WIND CURRENTS AND THEIR BEHAVIOR	133
XVII.	HOW BIRDS FLY AND SOAR	140
XVIII.	STATIC SOARING	145
XIX.	DYNAMIC SOARING AND ACROBATICS	151
XX.	DURATION AND LONG-DISTANCE FLIGHTS	157

Part Five

CONSTRUCTION

XXI.	MODEL BUILDING	169
XXII.	PREPARING FOR GLIDER CONSTRUCTION	175
XXIII.	HOW TO BUILD A GLIDER	183
XXIV.	MAINTENANCE	203

Part Six

EXPERIMENTATION

XXV.	THE GLIDING OF MOTORED PLANES	213
XXVI.	THE FUTURE OF GLIDING	217
	INDEX	229

PART ONE

INTRODUCTION

CHAPTER I. Why You Should Learn to Glide

CHAPTER II. How You Are Taught to Glide

CHAPTER III. The History of Gliders

CHAPTER IV. The Qualifications of a Pilot

The purpose of the Introduction is to give the reader a bird's-eye view of gliding. By reading it, he should obtain an idea of the purposes of gliding, of whether or not he is interested in learning to glide, and of his capabilities for doing so.

Chapter I recounts the advantages of being a glider pilot, and the uses to which gliders are adapted. A synopsis of the entire procedure of glider training and definitions of the commoner terms used in flight parlance are given in Chapter II. Chapter III outlines the history of motorless flight, from the earliest times. Chapter IV lists the qualities, physical and mental, which a glider pilot should have in order to be successful.

CHAPTER I

WHY YOU SHOULD LEARN TO GLIDE

MAN has always longed for the “wings of a dove.” Wings he has at last found. In a glider, he can poise almost motionless above the earth, or swoop downward like a bird upon his prey. Unlike the airplane, the motorless ship travels silently. A flock of sea gulls once joined a soaring glider and flew in formation with it, thinking it was kin to them.

Advantages of a Glider.—The glider has numerous features to recommend it. In the first place, it is comparatively safe. Its speed is ordinarily so low that, like a wind-blown leaf,

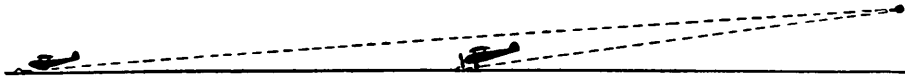

FIG. 1.—The relative sinking speeds of a glider and an airplane. A glider will traverse more than twice as much distance as an airplane gliding with its engine cut.

it sinks to the ground gently (see Fig. 1). In consequence, the accidents which have occurred in well-built gliders are negligible. Moreover, gliders are comparatively inexpensive. The cost of materials for building a primary glider is about \$150. One can be purchased complete for less than \$500.

Gliders can be flown wherever the terrain is undulating and unobstructed. Even over perfectly flat country, gliders which are suitably built can be launched into the air by towing them behind automobiles or motorcycles. Gliders may also be towed behind motor boats. Gliding, moreover, is not merely a seasonal sport like skating or tennis. Figure

GLIDING AND SOARING

2 shows that gliding may be done in winter as well as in summer.

Gliding as a Sport.—Gliders are being widely used for pleasure purposes. It is more exhilarating to slide along above the surface of the earth in a glider than it is to coast downhill on a sled. The pilot controlling a glider which does some prank with every gust of air feels greater mastery



FIG. 2.—Gliding is an all-year-round sport. This ship is about to be towed off the ice behind an automobile.

than does even the driver of an automobile or the rider of a spirited horse. William H. Bowlus has said:

Always I have felt more secure in a glider than in an airplane. You become a part of the machine. Its wings are your arms, outstretched that you may fly like a bird over meadows and across wooded hills. In an airplane, I must confess (and I have been a pilot for a decade) I always have the feeling I am hurrying somewhere, trying to keep pace with the world, annihilating distance, demolishing time.

In a glider, however, I hover over the world with absolute control over my wings; subject to the whims of the wind, perhaps, but not caring whether I sail up or down, depending not on man-devised power to pull me through the air.

WHY YOU SHOULD LEARN TO GLIDE

Because gliding is an incomparable sport, thousands of people in Europe and in America have become its devotees.

Gliding as a Means of Flight Training.—Aside from its value as a sport, gliding has numerous and practical applications. It is especially useful as a preliminary step in the training of pilots for motored planes. In this capacity, it will perhaps come into extensive use. The controls of an airplane are similar to those of a glider, so that some accomplished glider pilots have been able to handle the stick and rudder bar of an airplane and to solo after an hour or two of motored flight. Boys who are too young to handle high-powered planes, and would-be pilots for whom airplanes are too expensive a luxury, can do no better than to begin their flight training by learning to glide.

An interesting comparison between flying and driving an automobile is made by J. Don Alexander, president of the Alexander Aircraft Company, of Colorado Springs:

Gliding teaches the first steps in flying. The new pilot can learn the controls of the airplane and get the feel of the air at very small expense through this medium. It is becoming generally accepted in the aviation industry that we have gone about training from the wrong angle. Learning to fly has become an expensive and mysterious procedure with which the average individual has found himself physically and psychologically unable to cope.

We have tried to teach students to fly at high speed. Since the days of the cave man, human beings have been learning to coordinate their minds and their muscles up to the speed that they can run, approximately 30 miles per hour. Man is completely baffled when the speed is suddenly jumped above this figure. To train for greater speed, he must make the jump gradually.

This is illustrated by the automobile. Early automobiles kept their speed within the experience of the people who rode in them. They seldom traveled more than 30 miles an hour. As the driver's experience broadened, it became possible to increase speed with safety. Now they travel easily 60 miles per hour or more, and no one thinks anything about it.

With the automobile this increase of speed has brought no serious complications. It has been gradual and we have grown

GLIDING AND SOARING

accustomed to it. Operating the controls in an automobile is exceedingly simple. Turn the wheel to right or left. Use the feet to control speed.

In the past few years we have been trying to jump people into the air at from 40 to 60 miles per hour. It was too much. There was no background of experience. We have doubled the speed to which the average person is accustomed. To make the natural physical response relatively even slower, we have complicated controls. Operation of both stick and foot pedal is necessary to turn the plane to right or left. Then you have the up-and-down movements to think about. Add to this the fact that, in the airplane, there is practically no control of speed as far as concerns operation of the controls and you have the reasons for difficulties in learning to fly.

When you learned to drive an automobile you started going very slowly. Gradually as you gained confidence, you increased speed. Now you probably go as fast as the law allows and maybe faster. Consider the case of the airplane. You start learning at from 40 to 60 miles per hour. You even have to cruise faster than that. You can go no slower, for in that unaccustomed speed lies your safety. When you want to stop the automobile you pull up to the curb at 1 or 2 miles an hour; pretty safe and within your experience. Set a present-day airplane on the ground and you do it at 40 miles or faster. Under that you have no control at all.

Therein lies the logic of teaching airplane piloting in gliders. The student can learn the new system of controls within his speed experience.

All early air experiments were carried on by flying gliders. The machines were light affairs built of bamboo. Wing area was large. They could land or take off in a baseball diamond, at 30 miles per hour or less. You have often heard old-timers tell how they taught themselves to fly. No one ever trains himself to fly in the modern airplane. It is physically and psychologically impossible.

In modern methods of teaching, the Germans have been the first to recognize the difficulty of speed. Their airplane pilots must first be glider pilots. America is coming to accept this form of training, too.

Glider flying is the prospective airplane pilot's kindergarten. It shows surprising results in cutting down airplane instruction time before solo. A person can become a member of a glider club, and receive sufficient glider training to cut his airplane time before solo one-fourth to one-half.

WHY YOU SHOULD LEARN TO GLIDE

Gliding as a Method of Studying the Wind.—Comparatively little is yet known about air currents. Even powerful airplanes must be wary of storms, of unexpected gusts of wind, and of the sharp upward and downward currents of air caused by mountains and by inequalities of temperature.

The airplane is driven in one direction by its engine, and is, therefore, the prey of the various wind currents, which are apt to be blowing in quite another direction. The glider, on the other hand, instead of flying at cross purposes to the wind, tends to ride on it, and to utilize its power. The soarer derives its motive power from the upward currents of the wind, and even the simple downhill glide is “stretched” if taken into the wind.

The more efficient types of gliders, because of their light weight, slow speed, and finer aerodynamic design, are sensitive to every “bump” and gust of air. Consequently, the glider pilot, with all outdoors as his laboratory, is rapidly perfecting the science of the wind. He is able to discover the effect of the various terrains upon the wind currents, and how his tiny ship can utilize these currents. Some French airplane pilots, who are conversant with the principles of gliding and soaring, have “cut” their engines when over mountainous regions and have flown their planes as though they were gliders. Thus, gliding can be used as a means to safer and more expert motored aviation.

Potentialities of the Glider.—Although gliders were invented long before motored planes, their chief purpose, until recently, has been that of aerodynamic study. Comparatively little has been done to make them commercially useful. Countless ways of using gliders will, no doubt, be found in the course of the next few years.

There are several methods by which auxiliary power may be applied to gliders. Since most gliders are aerodynamically refined, it is possible for them to traverse long distances over the ground, while losing altitude very slowly. An airplane, on the other hand, if its engine is “cut” while in the air,

GLIDING AND SOARING

cannot glide nearly so great a distance as a glider released from the same altitude. Therefore, if the glider were supplied with some reliable means by which it could gain height, without greatly increasing its weight and resistance, it could travel for miles without an engine. Experiments have been made in which gliders were equipped with light engines. Other gliders have been shot into the air with rockets. As yet, however, no very successful plan of self-propulsion has been devised.

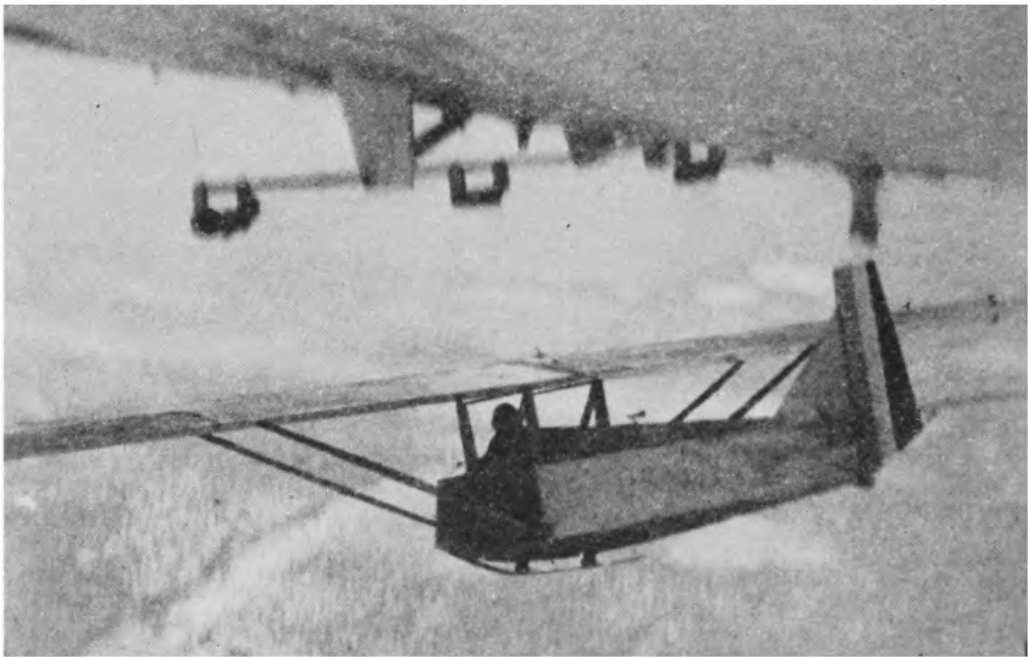

FIG. 3.—A glider taking off from a dirigible. The fact that a glider can be sent to the ground from a dirigible adds something to the value of motorless aviation. This photograph is of Lieut. R. S. Barnaby, leaving the Los Angeles.

It has even been found possible to launch gliders from a dirigible, and this offers some interesting possibilities (see Fig. 3). Gliders have also been towed behind airplanes. The gliders cut loose before coming in for a landing, in order to avoid collision with the motored planes.

* * * * *

Gliding has already served well the sport-loving and scientific Germans. It may safely be predicted that the

WHY YOU SHOULD LEARN TO GLIDE

speed-loving Americans will also consider it a science and a means of education worthy to supplement motored aviation. Lindbergh is reported to have said, at the end of his first glider flight, "That was the most simulating air ride I've ever had, and I'm going to do everything possible to speed the advancement of gliding. Isn't it strange that such a superlative sport has not come into more general use?"

CHAPTER II

HOW YOU ARE TAUGHT TO GLIDE

BEFORE learning to glide you should consider what form of instruction is most suitable and most easily available for you. A general idea of all the operations and maneuvers described in detail in Parts Two, Three, and Four of this book is highly desirable. This chapter is a synopsis of these sections.

Self-instruction.—There are, in general, three ways of getting glider training: by self-instruction, in a school, by joining a club. Before gliding began to be organized as a sport, every man built his own glider and taught himself to fly it. This was doubly dangerous, since the design of his ship was, more often than not, aerodynamically imperfect, and because the pilot, inexperienced in the control of his glider, was apt to lose his balance when in the air. Therefore, unless you have a glider which has been thoroughly tested by an expert, and unless you are already an accomplished motored-plane pilot, your one wise course will be to obtain instruction from a qualified teacher.

Schools.—One good way to obtain such instruction is to go to a glider school. Such schools are of two types: those where gliding alone is taught, and those airplane schools which make use of training in motorless ships as a preliminary step to dual instruction in an airplane.

Schools where gliding alone is taught are still few in this country. A camp at Wellfleet on Cape Cod, established in 1928, lays claim to being the first institution of its kind in the United States. Since that time, other gliding schools

HOW YOU ARE TAUGHT TO GLIDE

have been founded. At some universities, too, it is possible to obtain motorless flight training.

Those schools where gliding is used to complement power plane training are becoming more numerous. Such schools provide their pupils with ground training, as well as actual practice in the air. Doubtless, most flight training courses will eventually combine glider and airplane training.

No matter which of these types of school you choose, you are fairly sure to find well-built ships and instructors who are both good pilots and good teachers.

Clubs.—At present, the usual way of learning to glide is through a club. Here, you will find an organization of real sportsmen, who have secured the use of a gliding field, bought one or more ships, and procured an instructor.

Most communities in this country have terrain suitable for gliding purposes. The field may well consist of a ridge, or, if this is not available, a gentle slope, free from obstructions, and facing into the prevailing wind of the region. Even in perfectly flat sections gliders may be shot into the air with the elastic cable, and thus succeed in making short flights. Or they may rely upon automobiles, motor cycles, or motor boats to give them the necessary speed and, therefore, lift.

Chains of hills, 150 feet or more in height, are usually used for soaring. Soaring can also be done along the sea coast, or at the edge of a lake, where upward currents are plentiful. Even over level country, soarers have succeeded in remaining aloft by means of cloud currents.

Some clubs build their own ships, but this is inadvisable unless at least one of the members is thoroughly versed in the construction of planes. J. P. Schroeter, consulting engineer, and Technical Director of the Glider Club of Wisconsin, says:

My experience in our Club has demonstrated that it is of the greatest importance for the boys to build their own gliders. They learn so much in this work that even with no practical

GLIDING AND SOARING

gliding experience they get out of their club activities the greatest benefit. We further found that none of the factory-built gliders can compare with ours in workmanship. The necessity for repairs after many glides is easily accomplished if the boys know all details of construction. Of course, it is essential that good construction plans are available and that somebody can read and interpret them. Where there are not such boys or men, it is better to postpone any activity until they are found.

Nevertheless, the cost (to each member) of a factory-built glider is comparatively slight, and the factories are constantly improving the workmanship which they put into their gliders.

Clubs of from 15 to 30 members can usually afford only one glider, although it is always desirable to have more, since one glider is likely to be under repair a considerable portion of the time. If the members are very ardent fliers, with a good deal of time at their disposal, or if the organization has more than 30 associates, the club should certainly have more than one glider. Ships for advanced training will also be required, when the proper time comes.

Clubs should, if possible, provide hangars for their ships. A glider which is left outdoors, even if it is staked and weighted to the ground, may be injured by wind and weather. Some gliders can be folded or knocked down without too much effort, so that they will go into tents or garages.

A club should take great care in selecting its instructor. Not only must he be an able flyer, but he must also be able to impart his knowledge to his students. When all the members have learned the fundamentals of gliding, the instructor is no longer indispensable; but, although many people attempt to do so, and are still doing so successfully, it is wisest not to take the first steps in flight without direction.

Preliminary Knowledge.—It is advisable to have some knowledge of aviation before going into the air. There are several ways in which you can obtain such information:

HOW YOU ARE TAUGHT TO GLIDE

First, you can read some general textbook on gliding. You should know why it is that the glider stays in the air, what uses the parts of the ship have, and how its various maneuvers in the air are effected. Such preliminary knowledge will help you understand the instructor's directions.

Second, you can add to the facility with which you learn to fly, particularly for advanced work, by suitable ground training. This consists of actual constructional and repair work on ships, and of the study of various scientific subjects: principally, aerodynamics (that is, the study of forces which support the glider in the air), and meteorology, or the study of the wind and the weather. The importance of such a knowledge cannot be overestimated. Just as a knowledge of harmony is essential to the musician, so is a knowledge of aerodynamics and meteorology essential to the advanced pilot. Many of the most successful soarer pilots, especially in Germany, have been engineers or engineering students. If you are studying at a regular flying school, such a course is available; otherwise you will have to obtain it by experimenting and reading, either by yourself, or under the direction of your instructor.

Third, some experimenting with the controls on the ground before taking off will be helpful. If the ship is headed into a low wind, the ailerons, rudder, and elevators will take enough effect for you to grow accustomed to the plane's response to the control movements. In some schools, artificial winds, blowing upon the glider from different directions, are provided by propellers. Any such plan as this has distinct limitations, for it cannot give much of grasp of the essential theory of flight. Furthermore, the responses of the glider on the ground are quite different from those in the air.

Parts of the Glider.—The parts of the glider may be classified under four headings:

1. Fuselage.
2. Supporting surfaces.

GLIDING AND SOARING

3. Undercarriage.

4. Controls.

The fuselage is the body of the ship. To it are attached the wings and the tail group of controls. In primary training gliders, the student's body is purposely left open to the air; in this way he may the better get the ship's "feel." Advanced ships have cockpits. The cockpit is contained in the nose of the fuselage. The wings extend from either side of the fuselage.

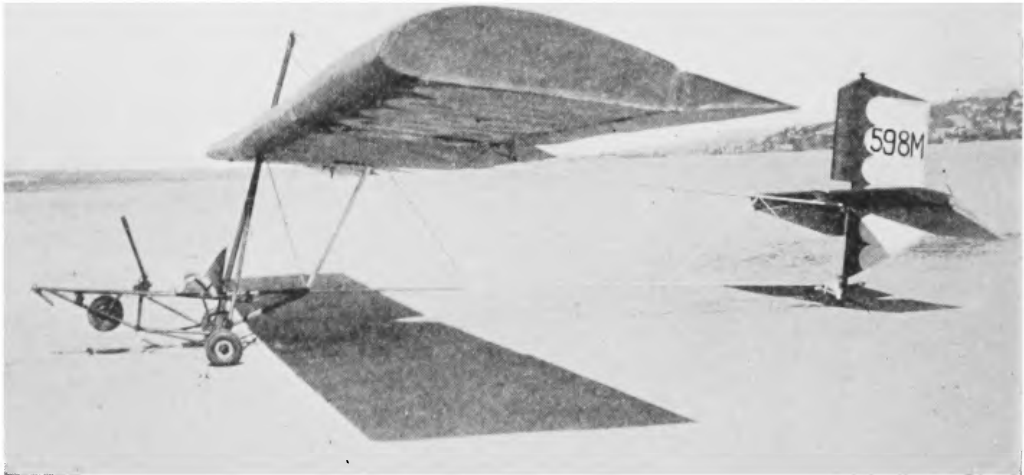

FIG. 4.—A primary training glider with wheels. Bowlus uses this ship for the instruction of beginners.

The undercarriage is that part of the glider which rests on the ground. It consists usually of a skid which is flexible enough to absorb the shock of landing. Sometimes small wheels form the undercarriage, but they add somewhat to the weight of the plane and even more to its resistance to the air. Air wheels with low pressure are, however, coming into use again, since they reduce the present difficulties of ground handling. Gliders which are started by being towed almost always have wheels (see Fig. 4). Water gliders have a fuselage like a boat and no undercarriage.

Controls.—The controls are nearly flat, fin-like surfaces hinged to the glider, which, when swung back and forth, direct the ship's movements in the air. These controls are

HOW YOU ARE TAUGHT TO GLIDE

called the “rudder,” the “elevators,” and the “ailerons.” The rudder, like a ship’s rudder, is attached to the glider in a vertical position, and serves to swing the nose of the plane to the right or left. The elevators are two horizontal “flippers” which move as a single unit. (Sometimes they are built as a single unit.) They turn the nose up or down, causing the ship to climb or dive. The rudder and the elevators are fastened to the rear end of the fuselage.

The aileron is a horizontal flap hinged to the trailing edge of each wing. The ailerons are interrelated so that when one is pulled up, the other is pulled down. Thus, they effect the rolling movement of the ship; that is, they depress one wing, so that the ship tips to one side, forming an angle with the horizon. This tilting of the ship is called *banking*.

Stick and Rudder Bar.—The movements of the controls are effected by the pilot from his seat. The ailerons and elevators are connected with the stick by cables, and the rudder is connected with the rudder bar. The pilot moves the stick with his hand, and the rudder bar with his feet (see Fig. 5).

Types of Planes.—Since mass production of gliders is not yet general, types of gliders are still heterogeneous. Some rough classifications may, however, be made. First, there is a distinction between gliders and soarers, although the two types often merge indistinguishably. Gliders usually have square-tipped wings, and they are comparatively stable; soarers have a broader span (*i.e.*, greater length from one wing tip to the other); they also have tapered wing tips, and they are very sensitive to every current of air. Primary training gliders, with open seats, are already fairly well standardized. Secondary training gliders, with enclosed cockpits, are becoming somewhat standardized. Soarers are of countless different designs.

Gliders may also be classified according to the number of wing surfaces: as monoplanes, biplanes, triplanes, etc.

GLIDING AND SOARING



FIG. 5.—The controls. The rudder-bar and stick can be seen plainly in this photograph. The rudder-bar and stick are connected by wires with the control surfaces (the rudder, elevators and ailerons) which direct the ship's movements.



FIG. 6.—A water-glider. This glider is built with a water-tight hull, so that it will take off from and land in the water. Glenn H. Curtiss, the builder of the ship, is shown in the cockpit. Mr. Curtiss was one of the pioneers of aviation.

HOW YOU ARE TAUGHT TO GLIDE

Most gliders are monoplanes. The wings of biplanes are usually placed one above the other; but some ships have occasionally been made in which the supporting surfaces were set one behind the other.

Motorless planes may also be divided into hang gliders and sit gliders. Sit gliders provide a seat, and sometimes a cockpit, for the pilot, and they are ordinarily equipped with stick and rudder bar. Hang gliders, now practically obsolete, are controlled mainly by the swinging of the pilot's body, which is suspended from the fuselage by his arms or otherwise. The early gliders were of this type.

Gliders may also be classified as water and land gliders. Water gliders are built to take off from and land on the water (see Fig. 6).

Gliding and Soaring.—Before you begin a study of motorless flight, you must understand the meaning of the terms, “gliding” and “soaring.” Gliding is the more inclusive term. It refers, in general, to flight in an engineless, heavier-than-air craft. Gliding may also mean, specifically, taking off from a height in a glider and coasting downward. As opposed to gliding in its restricted sense, is the word “soaring,” or “sail-flying.” Soaring means, not gliding downward toward the ground, but rising to a greater altitude by utilizing the kinetic energy of the air.

The First Flight.—The first flight will give you, all within a few seconds, an idea of how most of the important gliding maneuvers are performed. You will, perhaps, never have learned so much in so short a time! In general, the procedure on this momentous occasion is as follows:

The instructor tells you briefly about what you are to do. The ship is probably on the crest of a gentle slope, or perhaps you help to haul it up there. He tells you to get into the seat and to fasten the safety belt. He directs you to try moving the stick and rudder bar, and to observe the resulting movements of the control surfaces. He gives you some

GLIDING AND SOARING

instructions concerning the way in which you must handle the glider in the air, but he tries to make these so few and so simple that they will not be confusing. Then, before you have time to become agitated at the thought of your first leap into space, he directs the ground crew to launch your glider. If, during your short flight, you become uncertain as to what move you should make, keep your stick in neutral.

Most instructors advise their students to wear no goggles nor head-covering. You must learn to recognize currents of air by feeling them against your face.

This method of allowing the student to fly the glider entirely unaided from the very first is the one generally used in Germany and in the United States, but it is not the only method of instruction. Sometimes the student is towed behind an automobile at a low speed, about 12 miles per hour, until he is able to maintain lateral and directional stability while the glider is on the ground. Gradually, the automobile's speed is increased, and the student is allowed to take the glider a few feet off the ground. This teaches him the use of the elevators. When he has become proficient at this sort of maneuvering, he is allowed to take off from the side of a hill by means of a shock cord. When being towed behind an automobile, the student should wear goggles because of the dust.

On some occasions a method of dual instruction, like that used in airplanes, has been employed to some extent (see Fig. 7). Dual instruction is carried on in a glider built for two passengers, with two sticks and two rudder bars which move simultaneously. In such a ship, instructor and pupil can fly together, so that directions may be given in the air, and mistakes made by the pupil can be corrected by movements of the instructor's rudder bar and stick. This method has two disadvantages: the additional weight of another passenger decreases the plane's efficiency unless a corresponding amount of wing area is added, and the student does not learn to depend upon his own abilities so soon.

HOW YOU ARE TAUGHT TO GLIDE

You will undoubtedly enjoy your first flight. To control a glider gives one a feeling of mastery over the air, rather than of ecstatic joy. Gliding is a quiet, graceful pleasure, and a revelling in one's high degree of skill.

Take-offs.—A glider must have speed, in order to rise from the ground. Since it has no power of its own, it must be launched into the air by some exterior force. The commonest method of launching a glider is by means of a shock cord, or long rubber cable. This shock cord works like a sling



FIG. 7.—A two-passenger plane. In this glider both pupil and instructor may fly at once. Each cockpit is equipped with a set of controls, so that the pilot can correct wrong control movements made by the student. The pilot sits in front.

shot. The center of it is attached to the nose of the glider by means of a ring and hook. While the ship is held stationary by men at the tail, the rest of the ground crew run forward, pulling on the ends of the shock cord, and stretching out the rubber. At the command, the men at the tail let go their hold, and the glider is snapped into the air. This is called the catapult method of take-off (see Fig. 8). Several other methods in general use are described elsewhere.

Straight Flight.—Straight flight means flight in a path which diverges neither to the right nor to the left; it does

GLIDING AND SOARING

not mean horizontal flight, since the ship must glide downward in order not to lose speed. Straight flight is more difficult than you would expect, since the glider is inherently sensitive to any variation in wind velocity and direction; hence you must know how to counteract its tendency to “fall off” to one side, or to “yaw.” Moreover, you must learn at what downward angle the glider flies most efficiently (see Fig. 9).



FIG. 8.—A take-off. This glider has just been launched by a rubber shock cord which works in the manner of a sling shot. The shock cord is tardy about falling off the glider's nose, and has begun to pull the ship down again.

Stalls.—A stall is the loss of flying speed. Flying speed means having sufficient forward velocity so that the glider will maintain itself in the air and be under full control. The glider pilot's first rule is, “Keep flying speed!”

When the glider stalls, it loses altitude. A stall, therefore, will shorten the duration of your flight. Incipient stalls are not necessarily dangerous, since by proper handling the ship can be quickly brought out of them. The thing to do

HOW YOU ARE TAUGHT TO GLIDE

when the glider threatens to stall is to push the stick forward; eventually, the weight of the nose, which contains the pilot, and the lowering of the elevators, will force the glider into a dive, and speed will be regained. In a continued stall one wing will drop and you are liable to land badly crumpled up.



FIG. 9.—A glider in straight flight. This ship is flying straight ahead and not allowing one wing to drop below the level of the other. At the same time, it is gliding gently downward.

Landings.—It is very difficult to give inclusive rules for landing. There are, in general, two methods of grounding a glider, each suited to the ship used, and to the conditions of flight.

One method is to stall the ship when it is within a foot or so of the ground. It then settles to earth. The landing stall is produced by pulling the stick gradually back, so that the ship comes out of the glide into a horizontal position. Since

GLIDING AND SOARING

the plane gathers no additional speed under these conditions, its impetus is soon exhausted, and it will land gently. This method of landing requires skill. A stall at too great an altitude, and a consequent abrupt fall to the ground, must be avoided. Experience alone will give you the skill necessary to enable you to ground the plane smoothly. But gliding, properly done, under adequate supervision, is not a dangerous sport.

A simpler method of landing, suited to certain ships, is to keep the stick in neutral until the glider reaches the ground. This method is often used by experienced pilots, as well as by beginners. Only by experience, and by a knowledge of the glider which you are flying, will you know what terrain and weather conditions demand a stall landing.

Turns.—A turn is a divergence to the left or right from the straight path of flight. To make a turn, both rudder and bank are necessary. The rudder swings the nose to the side to which you wish to turn. Bank is necessary to offset centrifugal force, just as it is necessary on a speedway to prevent an automobile from skidding when it goes around a corner. It is the same principle which you unconsciously apply when riding a bicycle around a curve. You will need to practice turns a good deal before you will be able to use the correct amount of bank in proportion to the amount of rudder (see Fig. 10).

Dives and Climbs.—Dives and climbs are not used in simple gliding. Their principal purpose (although they have a few other uses) is for flying from one air current to another during soaring flight.

When the ship is gliding, it is at that angle to the horizon which will allow it to maintain flying speed; when it is diving, it is flying at an even greater angle to the horizontal, in order that it may gather additional speed by its momentum. A climb is the gaining of altitude by increasing the "angle of attack," that is, by raising the nose. Just as an

HOW YOU ARE TAUGHT TO GLIDE

automobile can gain enough momentum by coasting down one hill, with its engine turned off, to go halfway up the next hill, so a soarer can dive steeply from the height to which one air current has lifted it, then turn and climb into another air current.

Long Distance and Duration Flights.—One of the greatest interests of soarer pilots at present is to set new records for



FIG. 10.—A turn. The pilot of this glider is using rudder and bank in order to effect the turn. The ship here is banked to the right, *i.e.*, the right wing is lower than the left, in order to offset centrifugal force in a right turn.

long distance or duration. These men are anxious to convince the public that the glider is of real, practical value. Long distance flights are usually made by gaining altitude in some way, and then gliding downward slowly, covering as much ground as possible. The usual way of gaining altitude is by means of upward currents. Thus, most long-distance glider pilots repeat continually the process of gaining height by means of one upward current, gliding with as little loss of height as possible to another upward current, and gaining

GLIDING AND SOARING

more altitude through this one. If the upward currents are prevalent, and the pilot is skilled enough to be able to recognize and make use of them, he may be able to traverse many miles of country.

Duration flights are normally made by circling about for hours over one strong upward current, or by flying back and forth along a ridge of mountain peaks where several strong upward currents are to be found.

Conclusion.—As soon as you have acquired a little general knowledge of the procedure of the training which you are to be given, you are ready to assimilate more detailed information. Such information is given in the remaining chapters of this book.

CHAPTER III

THE HISTORY OF GLIDERS AND GLIDING

THE glider is sometimes spoken of as a fledgling, the offspring of the airplane. The metaphor is a false one: gliding was the earliest successful form of heavier-than-air flight. If the gasoline engine had not been invented, to direct into new channels the development of aircraft, it is conceivable that we might by this time be flying in highly efficient super-gliders, or other birdlike contraptions, instead of in motored airplanes.

The early development of the glider, although it extended over centuries, was marked by little progress. Lilienthal, who is fondly known in Germany as the father of modern planes, was able to sustain flight for a distance of only a few hundred yards, but even that was a great achievement. The Wright brothers, after long experiments with gliders, and as a direct result of such experiments, invented their motored plane in 1903. Between that time and the end of the World War, the attention that was devoted to gliders was somewhat abated. But in the past decade such strides have been taken in the field of motorless aviation that soarers are now available which fly for miles and can attain thousands of feet in altitude. The Germans, above all other people, are responsible for this tremendous advance. The Treaty of Versailles imposed upon them such restrictions regarding engine-driven aircraft that they were forced to turn their scientific genius toward the development of the glider. And they did so with splendid result.

Classic Examples of Gliders.—Since time immemorial, men have tried to imitate the birds. Even mythology

GLIDING AND SOARING

describes such attempts, notably those made by Daedalus and his son Icarus, who built wings from feathers fastened together by wax. As Ovid recounts the myth, Daedalus flew safely from Crete to Sicily; but Icarus, in spite of his father's warning, flew too near the sun, the wax melted, and he fell into the sea.

Between 400 and 200 B.C., experiments were made with man-carrying kites, which are, after all, first cousins to gliders. Archytas of Tarentum was, according to tradition, the first man to achieve flight in a heavier-than-air machine. Contemporaneously, the Chinese were developing the potentialities of kites.

Leonardo da Vinci, who was almost as great a scientist as he was a painter, evolved some theories of his own on the subject of flight. His most notable contribution to aviation was the invention of the parachute. He also built a flying machine. This was a batlike device, with rudders on the wings and tail which were to be moved by the arms and legs of the pilot. This invention had little chance of success, since no pilot was strong enough to control it! Leonardo is said also to have been the first man to experiment with the helicopter.

The First Successful Gliders.—No consistently successful glider flights were made until the beginning of the nineteenth century. Sir George Cayley, an Englishman, built a glider which would fly for several yards at a time. He described his ship as "a beautiful white bird," which would "sail majestically from a hill to any given point of the plain below it." The discoveries which he made were the basis for aeronautical research during the next fifty years, and his success excited a good deal of interest in flying. The building of model gliders became the vogue at this time. Numerous new designs and principles were developed as a result.

One of the first glides of any length is said to have been made by a French soldier, named Le Bris. He built a ship

THE HISTORY OF GLIDERS AND GLIDING



FIG. 11.—One of Lilienthal's gliders. This glider was built and flown by Lilienthal in 1894. In designing the bat-like wings, he utilized the principle that curved wings are more efficient than flat ones.



FIG. 12.—Another view of Lilienthal's glider. This photograph shows very plainly the way in which the pilot swung his body in order to bank the ship.

GLIDING AND SOARING

fashioned after the albatross. It was launched by being carried on top of a wagon behind a horse, until the horse ran fast enough so that both glider and pilot were lifted into the air. Le Bris told a fanciful tale of how, during his entire first flight, the coachman, who had become caught in the glider's mooring rope, was dragged through the air suspended from the ship.

The efforts of Le Bris were supplemented by those of another Frenchman, Mouillard, who made a flight of several seconds' duration in a tailless monoplane.



FIG. 13.—A glider built by Pilcher in 1897. This glider, of individual design, embodies the principle of cambered wing surfaces. It was the most successful of Pilcher's gliders, weighed 50 pounds, and once flew a distance of 100 yards.

Otto Lilienthal.—The earliest glider flights were merely “slides downhill.” But Lilienthal discovered the principles of soaring. This German had, as a foundation for his experimentation, an extensive knowledge of birds and of mechanics. He built and flew a number of gliders (see Figs. 11 and 12), and made many important discoveries between 1891 and 1896.

He came to the realization that a curved wing surface had more lifting power than a flat one. The principle of camber was brought to light at about this same time by an Englishman, Pilcher (see Fig. 13). Lilienthal observed the

THE HISTORY OF GLIDERS AND GLIDING

increased efficiency which a glider obtains by flying directly into the wind. He came to the conclusion that the biplane was the most easily controllable type of ship. He learned to direct his path of flight by rudimentary fins. The wings of his glider could be moved like a bird's wings, so that lateral control would no longer depend upon shifting the weight of the pilot's body.

Lilienthal's death resulted from the crash of the last glider which he built. During his lifetime he had made more than 2,000 flights, in some of which he covered more than 300 yards of distance, and stayed in the air more than 15 seconds. He had been able not only to fly straight, but also to make turns, and on some occasions to return to the taking-off place.

Early American Contributions to Gliding.—In the period following Lilienthal's death, the notable advances in the construction and flight of gliders were made by Americans, of whom the most illustrious were Chanute, the Wright brothers, and Montgomery.

Chanute flew at first in gliders of the Lilienthal design. Soon, however, he began to build ships of his own invention. After experimenting with gliders having respectively five (see Fig. 14) and three superimposed wings, he built a biplane. This was controlled by body movements, supplemented by a horizontal rudder and fore-and-aft movements of the wings. In 1896, he made approximately 1,000 flights.

Until 1900, virtually all gliders were hang gliders. Wilbur and Orville Wright built the first in which longitudinal, lateral, and directional movements were directed by manual control. They employed warpable wings instead of ailerons, and theirs was the first full-sized glider to be equipped with a movable vertical rudder. This ship was more efficient than any of its predecessors, partly because the pilot lay down on the wing, instead of hanging or sitting. In this way, the resistance was reduced. This glider is shown in Fig. 15. Even after their success with powered planes, the Wrights

GLIDING AND SOARING

continued their work with gliders, and set a flight record, in 1911, of 9 minutes and 45 seconds (see Fig. 16).

Montgomery, a Californian, who is said to have made the first flight in a glider in the United States, considered soaring of greater importance than motored flight. In 1884, he had built a glider with tandem wing surfaces, fixed vertical rudder, elevators, swinging wing tips, and a seat which slid from side to side to effect lateral control.

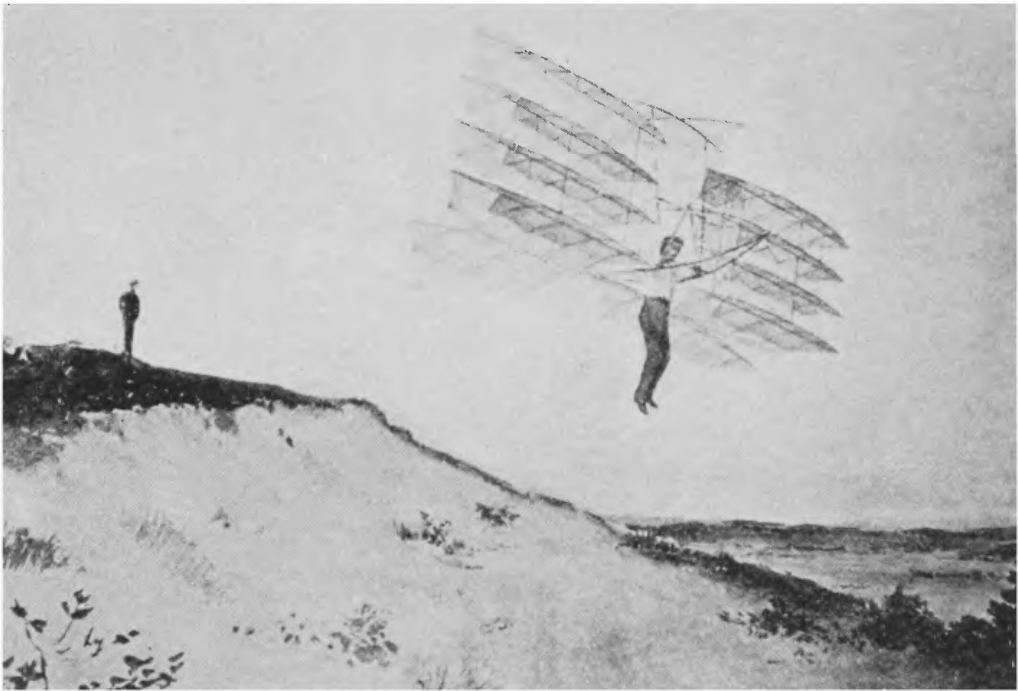

FIG. 14.—A five-wing glider built by Chanute in 1896. This ship, designed by Chanute, proved less successful than a biplane.

In 1905, he built a light-weight glider, the “Santa Clara,” and had it, with its pilot, lifted to a height of 4,000 feet by means of a hot-air balloon. When the pilot cut loose from the balloon, he was able to execute many complicated and graceful feats before he reached the ground. Figure 17 is a photograph of this glider.

Figure 18 is a photograph of an early glider made by another great American aviator, Glenn H. Curtiss, who has aided greatly the recent development of motorless aviation.

THE HISTORY OF GLIDERS AND GLIDING

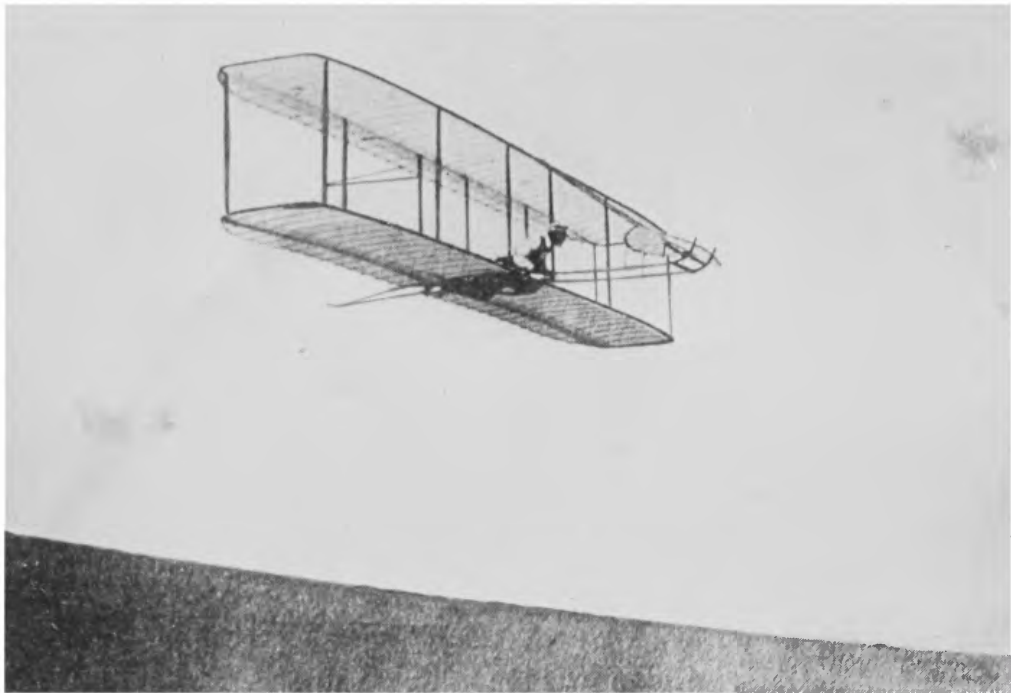

FIG. 15.—An early Wright glider, built in 1902. This ship was equipped with a system of manual controls, so that the pilot was able to lie down, instead of hanging. In this way, the parasite resistance was considerably reduced.

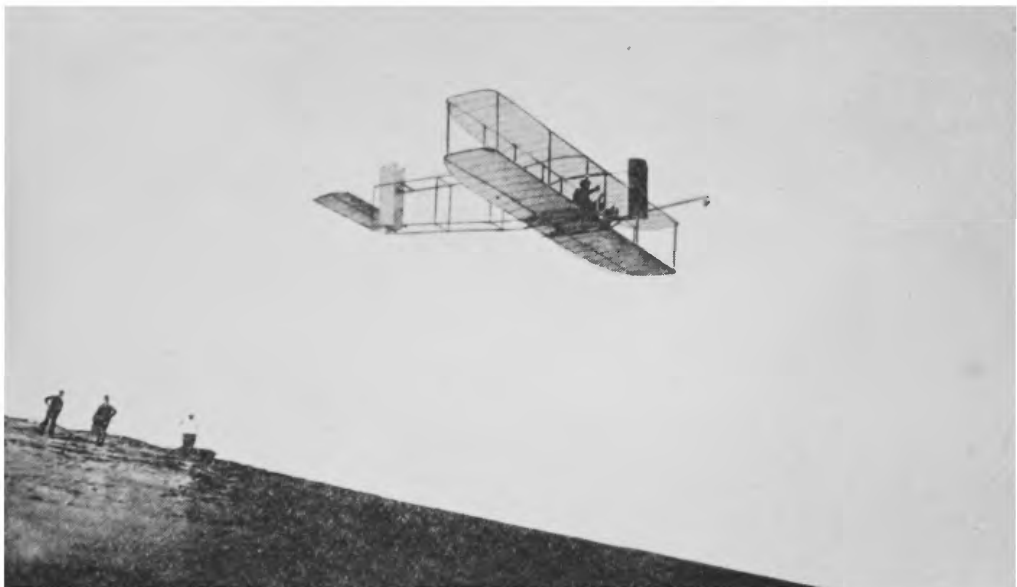

FIG. 16.—The Wright glider of 1911. This glider, in which a record was set, has a control system very similar to the one used at present.

GLIDING AND SOARING

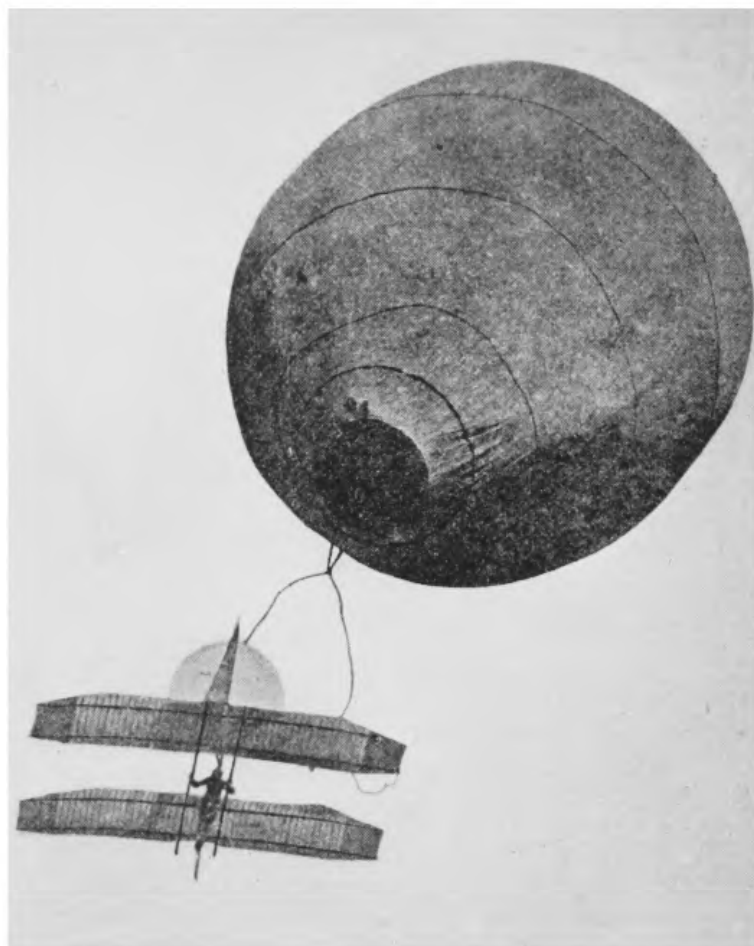

FIG. 17.—The glider built by Montgomery in 1905. In the photograph, the glider has just cut loose from a hot-air balloon. Montgomery's device for gaining altitude is comparable with the modern method of releasing gliders from dirigibles.

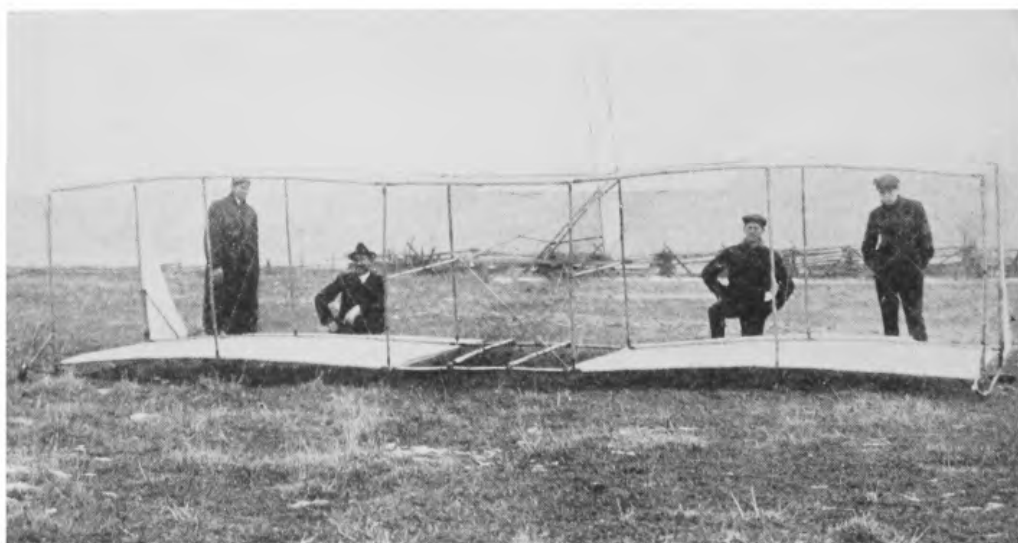

FIG. 18.—An early Curtiss glider.

THE HISTORY OF GLIDERS AND GLIDING

Glider Development, 1903 to 1920.—Between the time of the invention of the first airplane and the end of the World War, interest in motorless flight subsided. But the development of the glider went on in a latent manner, in the development of the airplane. Certain principles of control (*e.g.*, the aileron) and of design (*e.g.*, streamlining), which were being elaborated in order to make the airplane more efficient, were later adopted by glider designers. Figure 19 suggests the type of developments which were being made

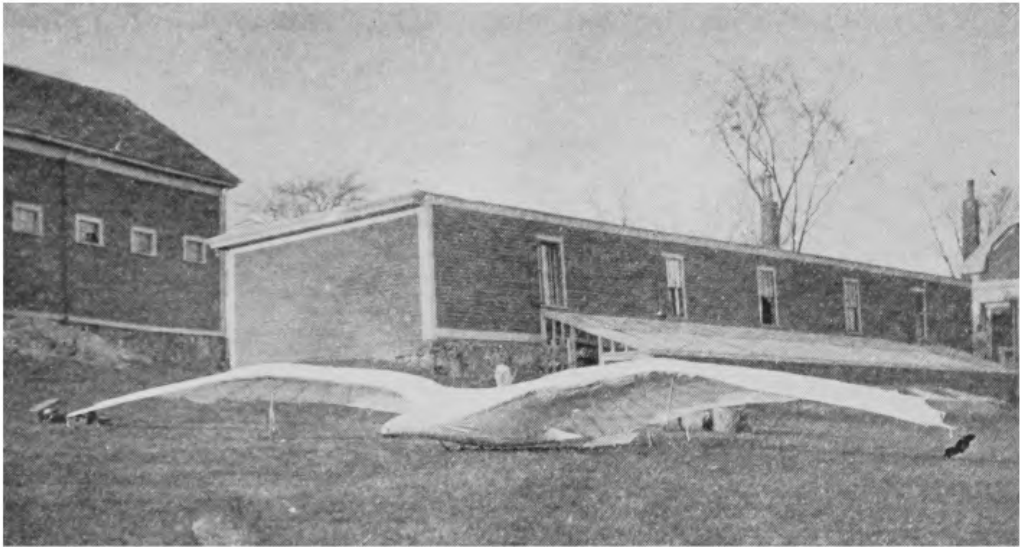

FIG. 19.—A glider built by Percival White in 1912. This in many ways resembles the present-day soarer. It made use of the principles of enclosed fuselage, landing skid, cantilever wing, stream-lining, monoplane construction, and flexible wings.

at this period. The advanced type of gliders which have been built since the war are much like motored planes in form, except that they have broader span. They have streamlined bodies, and they tend more to the monoplane than to the biplane type.

During this period, airplane development, as well as glider development, was practically nil in regard to aerodynamical construction of the plane. The main object since the time of the Wright brothers was to improve the engine and to achieve by sheer mechanical force what perhaps

could better have been accomplished by further experimentation with gliders and soarers. During the war, especially, results were achieved principally by engine power, as safety of design was not such a factor. After the war, the airplane emerged as a device which was neither safe nor commercially efficient. At this point the glider movement started in Germany, and new and better designs were evolved.

Glider Development since the War.—The metamorphosis which has occurred in the field of motorless aviation within the last decade is breathtaking. The record of the Wright brothers was broken by Hentzen in 1922, who flew for 3 hours and 6 minutes; by Kronfeld, who, in 1929, traversed over 90 miles in a single flight; and by Ferdinand Schulz, who, in 1929, remained aloft for more than 14 hours. The improvements which have been made in glider construction may be partly comprehended by a reading of the chapters on What the Glider Looks Like and How the Controls Work. The chapters on soaring give a rough idea of the development in glider flight which has taken place since the time of the Wrights.

The Germans, who began to form glider organizations before the commencement of the war, and who have accepted gliding as a national sport, have been the major contributors to the development of the science. Nevertheless, several waves of glider enthusiasm have swept over the United States (as well as over England and France). Bowlus, an American, in February, 1930, stayed aloft for over 9 hours, establishing a record for the United States.

Conclusion.—Until the invention of the airplane, the history of gliding was the history of flight itself. The fact that gliders and airplanes now exist as separate entities does not necessarily mean that the divergence between the two forms of ships will be lasting: the advantages of the one will be merged with the advantages of the other.

THE HISTORY OF GLIDERS AND GLIDING

At any rate, the progress of gliding is watched with joy by aeronauts of all sorts. The Allies, in depriving the Germans of powered airplanes, did a tremendous service (unknowingly) to the future of aviation.

CHAPTER IV
QUALIFICATIONS OF A PILOT

PRACTICALLY all persons within certain age limits, who have no physical or mental deficiencies, can learn to become glider pilots. Nevertheless, not all of these can become good pilots. Many of the qualities which go to



FIG. 20.—Everyone knows what Lindy's qualifications are. A prospective pilot can estimate his own abilities by comparing them with Lindbergh's. He who compares favorably is fortunate!

make up a good pilot are definable, and will be cited here. It is difficult to predetermine the aptitude of any one who has not yet flown (see Fig. 20).

QUALIFICATIONS OF A PILOT

It is evident that the requisites for successful soarer pilots are much more exacting than those for the pilots who merely glide downhill; but every glider pilot expects to soar.

Age.—One of the great advantages of gliding as a means of flight training is the fact that gliders can be flown by youngsters not old enough to obtain airplane licenses. (Airplane licenses are not granted to persons less than 16 years of age.) Nevertheless, the minimum age limit for glider pilots must be set somewhere in the neighborhood of 14 years: a certain degree of physical strength and maturity of judgment are necessary for successful gliding. Boys and girls of 14 are exceedingly quick to learn, and actions readily become instinctive to them. They have passed the stage where they were content to fly model airplanes; they are still too young to fly motored planes; gliding stimulates their interest in aviation.

Just as people between 20 and 30 have so far proved the most apt students of motored flight, so are they also the most efficient and adaptable glider pilots. On the other hand, few who are in possession of all their physical and mental faculties are too old to learn to glide.

Women as Glider Pilots.—So far, although gliding offers as splendid opportunities to women as to men, few women have made noteworthy glides. Gliding is a gentle sport, and requires a readiness of decision in which many women excel men. The success of the Berlin Women's Club and the Anne Lindbergh Gliders is indicative of what may be expected.

Physical Qualifications.—Only average muscular strength is necessary for the glider pilot. But a sound general physical condition is essential. The pilot with unsteady nerves, faulty heart or lungs, might fare ill because of an air bump or a sudden landing. Moreover, the pilot must have a good

GLIDING AND SOARING

sense of balance. A test used in the army for power-plane pilots is for the prospective ace to maintain his equilibrium for 20 seconds, while standing on one foot with his eyes closed. Quick perception, keen sense of observation, quick reaction and steady nerves are desirable, but may be developed in most youngsters. The glider develops one's powers of endurance!

The ill effect which any single physical defect will exert cannot be estimated beforehand. One person might be greatly handicapped by a defect, while another, with the same defect, might have other qualities to offset his deficiency entirely.

Vision.—Since the glider's speed is comparatively low, glider pilots perhaps do not need such good vision as motored-plane pilots. Nevertheless, glider pilots must be able to judge altitude and distance by eye; hence, color blindness or double vision might, on occasion, be serious drawbacks. The fact that pilots maintain a straight course by keeping their eyes fixed on a distant sight, also makes good vision of importance.

Hearing.—The hearing which the pilot must possess is not so much the ability to hear faint sounds as it is the power to distinguish one sound from another. As the speed of the glider becomes greater, the humming of the wind through the struts and wires grows higher pitched. The pilot should be able to calculate his speed through the air, by being able to recognize these variations in pitch.

Judgment.—It is of the utmost importance that the glider pilot have good judgment. In fact, judgment is a quality quite as essential to him as to the airplane pilot. Airplanes may depend normally on controlled power; gliders must be flown as the particular weather conditions of the day may dictate. The great difference is that failure to judge promptly and wisely in an airplane may be fatal;

QUALIFICATIONS OF A PILOT

whereas the same failure in a glider will usually result only in the flight's being cut short.

Promptness, as well as coolness, of judgment is necessary. Although the glider itself does not travel fast, air currents are fleeting, and the pilot must decide how to avail himself of them immediately, and act upon his decision, or they will be gone.

Concentration.—A pilot must possess the power to concentrate. This is necessary both while he is learning to glide, and after he has become an able soarer. During his first flights, he must be able to focus his attention exclusively upon the moves which he must make in order to guide his ship. When the use of the controls has become instinctive to him, he must be alert to every floating leaf, every flying creature, every contour of the earth, which may indicate a useful current of air. Care should be taken, however, that this concentration does not develop into overconcentration, or nervous tenseness. The pilot who worries about imagined danger cannot properly appraise the problems immediately at hand.

Courage and Confidence.—The courageous pilot is not the one who feels no qualms, but is, rather, he who is able to comport himself with coolness no matter how terrified he may be. Courage is certainly necessary in gliding, for the idea of leaving the earth entirely, and rising into the air, is still a novel one. After a few flights, the pilot discovers how free from danger gliding actually is.

Confidence in the plane and in one's ability to handle it is frequently not acquired by the pilot until he has had some experience. Once acquired, it is an important asset. Yet overconfidence should be avoided, since it lessens the pilot's good judgment, and encourages him to act carelessly.

Motored-plane Pilots as Glider Pilots.—Motored-plane pilots have not, in general, found that they have much

GLIDING AND SOARING

advantage, at first, over complete novices. It is difficult for them to accustom themselves to the low speed of the glider, to its sluggish response to control movements, and to its inability to climb. They keep feeling for the "gun." On the other hand, some power-plane pilots who understood the principles of soaring flight have made considerable progress in gliding from the outset: Lindbergh stayed up almost a half hour on his first trial. And all motored plane pilots, once they have acquired the feel of a glider, find that their flight knowledge stands them in good stead.

License Requirements.—The National Glider Association, Inc., prepared the rules for obtaining glider licenses. These rules were later approved by the National Aeronautic Association. Licenses are granted purely for the demonstration of ability, without specification of physical or other required qualifications of the pilot:

For the Third Class license, the pilot must keep a primary training glider or a secondary training glider in the air for 30 seconds in a flight straight downhill and give such other evidence to the examiners as they may require that he is competent to handle a simple glider under normal circumstances.

For the Second Class license, the candidate must fly a primary or secondary training glider for 1 minute downhill, making a full right and a full left, or "S," turn.

For the First Class license, the candidate may enter any type of glider and must fly for 5 minutes at an altitude higher than the starting point.

A Third Class license is required before the second test may be given, and the Second Class license must be shown by candidates for the First Class license. Examinations may be given by any authorized National Glider Association contest committee.

PART TWO

GROUND INSTRUCTION

CHAPTER V. The Wind and the Weather

CHAPTER VI. Kites and What They Teach about Gliding

CHAPTER VII. What the Glider Looks Like

CHAPTER VIII. Why the Glider Stays in the Air

CHAPTER IX. How the Controls Work

Part Two is a description of those principles of flight which every pilot must know. These principles may be learned before the reader starts to glide at all, or they may be read in conjunction with, and as a complement to, actual flight training.

Chapter V outlines the elements of Meteorology, and describes the varying conditions of the atmosphere. Chapter VI tells how kites may be built and flown, in order to make clear some of the essentials of motorless flight. The various parts and the construction of several types of gliders are described in Chapter VII. Some aerodynamical theorems concerning airfoils are explained in Chap. VIII. Chapter IX describes the different methods by which gliders are maneuvered while in flight.

CHAPTER V

THE WIND AND THE WEATHER

BEFORE you venture into the air in a glider, you must learn why and how it flies. If a skilled pilot teaches you to glide, he will doubtless give you some ground instruction about the wind, the weather, and the reasons why the glider stays in the air. Any person who intends to learn to glide or who is already taking gliding lessons should become thoroughly acquainted with these subjects.

In order to understand why a glider flies, you must first learn something about the atmosphere. Wind, or the continued movement of the air, and weather, or the various heat and moisture conditions of the air, are matters of vital importance to the pilot.

Atmospheric Pressure.—The air, or atmosphere, is a sea of gas surrounding the earth. With increasing altitude, the atmosphere becomes lighter, until finally it becomes too thin for man to breathe.

Just as the sea of water is heavy and presses down on the sand in its bed, so the air is heavy and presses down on the surface of the earth. Air has no form, but has the tendency to fill all available space. The weight of the atmosphere is normally about 14 pounds on every square inch of the earth, of your body, and of all the other things with which it comes in contact. You do not notice the pressure on you, because your body is also filled with air, counterbalancing this pressure. The pressure of the atmosphere, however, is not always uniform. Warm air is thinner than cold air, and therefore exerts less pressure. Dry air is not so heavy as air which is loaded with moisture.

GLIDING AND SOARING

How Atmosphere Is Measured.—Since knowledge of the amount of atmospheric pressure aids the pilot in predicting weather conditions, he must know how to read a barometer. A barometer is an instrument which measures the pressure of the air.

How to Make a Barometer.—A rough sort of barometer may be made by filling with mercury (quicksilver) a glass tube, closed at one end, and a little over 30 inches in length. Invert the open end, without admitting air, and place it in a

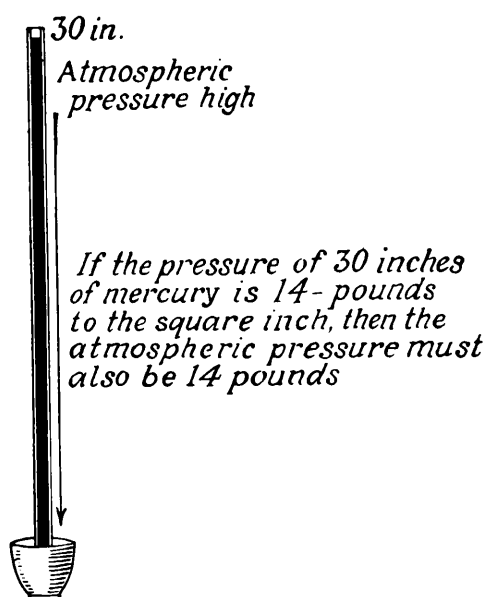

FIG. 21.—A barometer.

cup containing more mercury (see Fig. 21). The mercury starts to run down from the tube into the cup; but the pressure of the atmosphere on the surface of the mercury in the cup holds the mercury up into the tube. When the weight of the mercury in the tube is equal to the pressure of the atmosphere, no more mercury runs down out of the tube. If the atmospheric pressure is high, the mercury will stand near the top of the tube; if low, the mercury will fall. The tubes of barometers have to be made accurately. They are graduated to show how high the mercury column will stand at the various amounts of pressure.

Barometers must be used in airplanes to measure altitude. As the airplane climbs higher, the air becomes thinner and the atmospheric pressure less. Since a barometer containing mercury would be useless in an unsteady plane because it would be impracticable, airplanes are equipped with aneroid, or non-fluid, barometers. In barometers of this type, the expansion and contraction of air confined in a metal box, varying with the atmospheric pressure, move its thin walls. This movement is used to actuate a pointer or hand, like that of a clock.

Winds.—The atmosphere never remains still. It moves about over the surface of the earth. This movement of the atmosphere is due, in part, to its varying temperatures. Heavy, colder air, of greater density, is always moving to displace light, warmer air, of lesser density. It is this moving air which is called the wind.

Far above the trees and the mountains, the wind blows almost steadily in certain general directions. The atmospheric pressure at the equator is rather low, because of the intense heat there, and the cold air from the north and south poles blows continuously toward this light air. In North America, these winds do not blow directly north to south, however, but are deflected in an easterly direction, owing to the rotation of the earth.

At low altitudes, the winds are diverted from their general courses by irregularities in the surface of the earth. Just as rocks deflect the current and sometimes cause eddies in a river, hills and mountains deflect the wind upward and, if too abrupt, cause whirlpools in the air. Moreover, the earth changes temperature more rapidly than water, and this causes regular land and sea breezes. During the daytime, the land is warmed by the sun, and the winds blow from the water across the land. At night, the earth cools more rapidly than the water, and the breezes blow toward the sea.

GLIDING AND SOARING

How to Measure the Velocity of the Wind.—Since the wind is one of the essential factors in glider flight, it is necessary to have some means of calculating its velocity. The speed of the local winds which are near the earth can be measured by what is called an anemometer (see Fig. 22). An anemometer consists of hollow cups projecting from an axis which revolves when the wind catches the cups. The speed

TABLE I
AN AID IN ESTIMATING WIND VELOCITIES¹

Directions for estimating velocity from visible effects of the wind	Velocity, statute miles per hour	Terms used in U. S. Weather Bureau reports
Calm, smoke rises vertically.....	Less than 1	Calm
Direction of wind shown by smoke drift, but not by wind vanes.....	1 to 3	} Light
Wind felt on face; leaves rustle; ordinary vane moved by wind.....	4 to 7	
Leaves and small twigs in constant motion; wind extends light flag.....	8 to 12	Gentle
Raises dust and loose paper; small branches are moved.....	13 to 18	Moderate
Small trees in leaf begin to sway; crested wavelets form on inland waters.....	19 to 24	Fresh
Large branches in motion; whistling heard in telegraph wires; umbrellas used with difficulty.....	25 to 31	} Strong
Whole trees in motion; inconvenience felt in walking against wind.....	32 to 38	
Breaks twigs off trees, generally impedes progress.....	39 to 46	} Gale
Slight structural damage occurs (chimney pots and slate removed).....	47 to 54	
Trees uprooted; considerable structural damage occurs.....	55 to 63	} Whole gale
Rarely experienced; accompanied by wide damage.....	64 to 75	
.....	Above 75	Hurricane

¹ Wind velocity is the rate, in statute miles per hour, at which the wind is blowing. The U. S. Weather Bureau uses the terms given above for reporting wind velocities. This table will be of considerable help in assisting the pilot to estimate wind velocities.

THE WIND AND THE WEATHER

of rotation of the axis is recorded on a dial. The speed of the high air ("winds aloft" or "upstairs," in aero slang) is measured from weather stations by small balloons, the drift of which is measured.

The pilot who has no instruments can judge the velocity of the wind with some exactness by watching the effect of

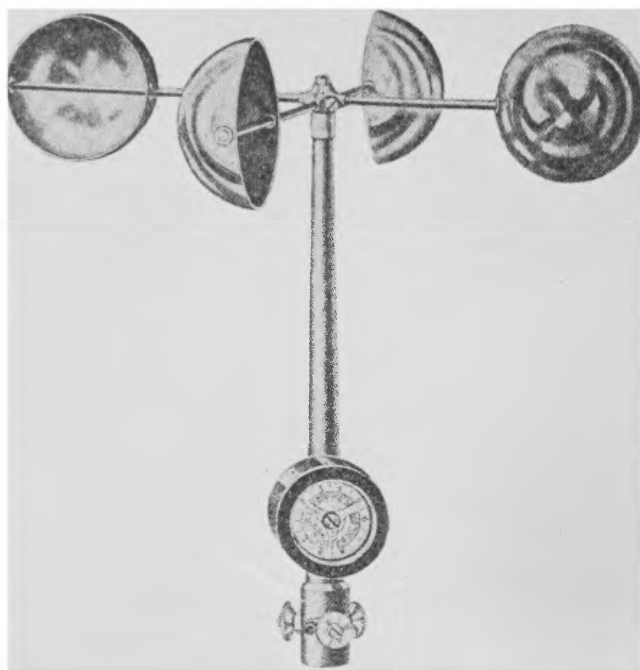

FIG. 22.—An anemometer.

the wind on trees, grass, etc. Table I should help him in making this estimate.

Humidity.—Humidity is the moisture content of the air. When the temperature of the air is so lowered that the air is holding all the moisture it can, it is said to be at the "dew point." Any lowering of the temperature will result in dew. The dew point means fair weather for the air pilot.

When the earth's surface is cooled enough to condense the moisture in the air, fog is formed.

Cloud Formation.—The study of cloud forms is very useful to the pilot, since it will give him valuable information about the kind of weather he may expect, and because

GLIDING AND SOARING

some kinds of clouds may be utilized for lifting the soarer. Clouds consist of water vapor which has condensed because of the cooling off of ascending warm air. There are several types of cloud formation.

Cumulus.—Cumulus clouds are the most important to the glider pilot because they indicate upward currents of air. They are thick, the upper surface being usually dome-

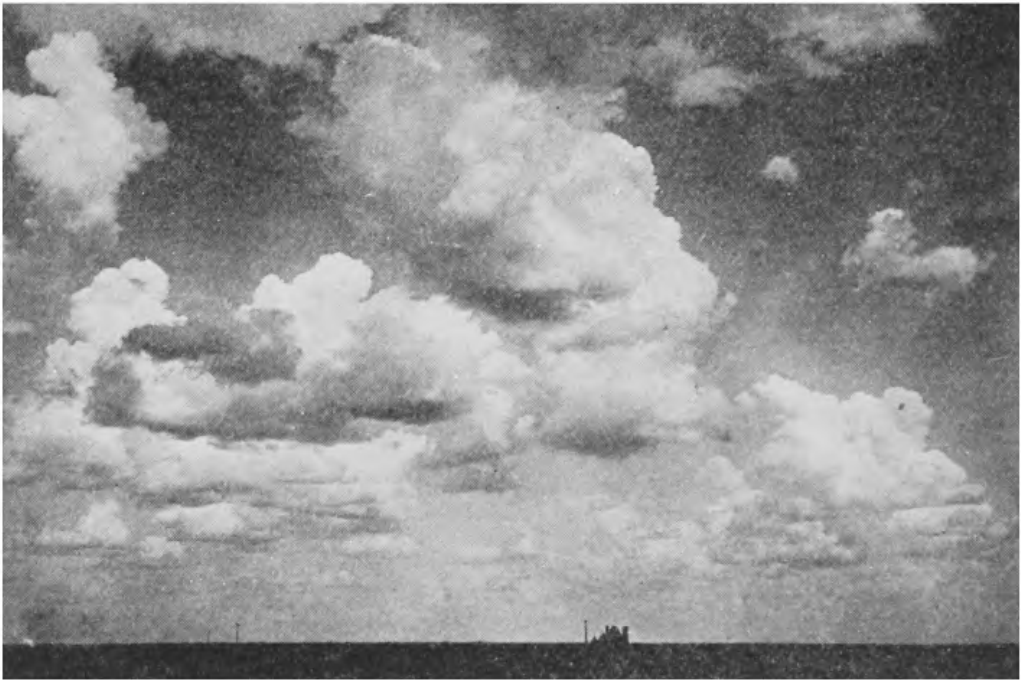

FIG. 23.—Cumulus clouds. Every glider pilot should learn to recognize the clouds. They are indicative of upward air currents which may be useful to the soarer.

shaped and the base horizontal. They are formed by the condensation of rising currents of warm air. The ascending air below cumulus clouds has great lifting power and soarers have been able to travel to considerable heights by means of its energy (see Fig. 23).

Cirrus.—Cirrus clouds are composed of ice crystals and are of delicate appearance, fibrous structure, and feather-like form. They take the most varied shapes, such as branch filaments in feather form, and straight or curved filaments

THE WIND AND THE WEATHER



FIG. 24.—Cirrus clouds. Cirrus clouds are usually detached and nearly white in color. They appear in various, feather-like forms.



FIG. 25.—Nimbus clouds. These are rain clouds, and usually mean that the weather is not suitable for gliding.

GLIDING AND SOARING



FIG. 26.—Stratus clouds. This is not the only form in which stratus clouds appear: they may be torn into shreds by the wind or rent by mountain tops.



FIG. 27.—Cumulo-nimbus clouds. These are the “thunder heads” from which showers fall. They are combinations of a cumulus top with a nimbus base.

ending in tufts. They usually presage good weather (see Fig. 24).

Nimbus.—Nimbus clouds usually form a dense layer of dark, shapeless cloud with ragged edges. They are usually characterized by steady fall of rain or snow (see Fig. 25).

Stratus.—Stratus clouds are uniform layers of foglike cloud. They hang low, but do not lie on the ground. The cloud layers of stratus are always very low, and they differ from other cloud masses in their lack of structural detail (see Fig. 26).

Cloud Combinations.—Many clouds are combinations of several cloud forms, such as cirro-cumulus and cirrus-stratus. The most important of these, however, is the cumulo-nimbus, which is the thunder storm or shower cloud (see Fig. 27). In this formation, great masses of cloud rise in the form of turrets or mountains. They usually have a veil or screen of fibrous texture at the base and top. From the base local rain or snow is precipitated. Sometimes the upper margins have the compact cumulus shape; sometimes they are arranged like cirrus clouds.

Weather Predicted by Clouds.—When clouds at sunset are red, the weather will probably be fine. If there is a yellow sunset it will probably rain or be windy. Gray clouds at sunrise mean sunny weather and red clouds wind and rain. Sharply defined clouds mean wind; soft ragged ones, rain; increasing cloudiness, bad weather; small white clouds high in the air, fine weather. By watching the clouds, too, the pilot can tell which way the wind is about to blow, for when a high cloud is moving in a different direction from the surface wind, the wind is apt to change to the direction in which that cloud is moving.

Precipitation.—Rain is made by the same process of condensation, carried to a greater extent, which produces

GLIDING AND SOARING

clouds. The moisture in the clouds becomes too heavy for the atmosphere to support. If the temperature is low, the moisture will condense into snow or hail instead of rain drops. Ice barnacles, or ice on the wings of a plane or glider,

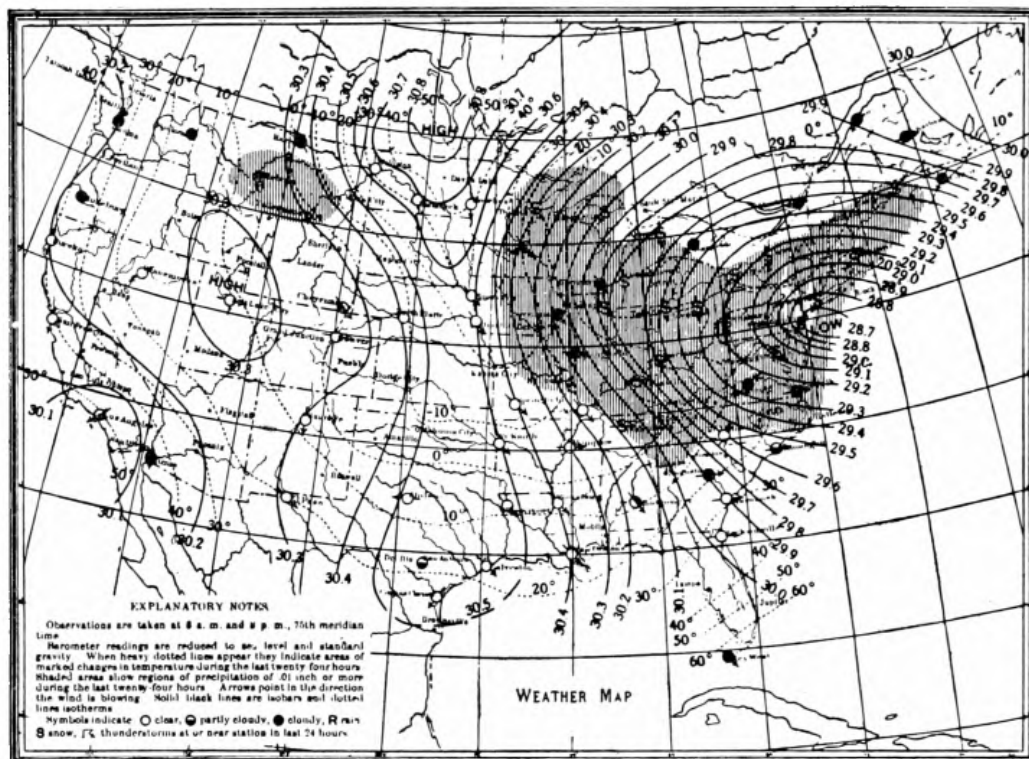

FIG. 28.—U. S. Weather Map.

“When the wind sets in from points between south and southeast and the barometer falls steadily, a storm is approaching from the west or northwest, and its centre will pass near or to the north of the observer within twelve to twenty-four hours, with winds shifting to northwest by way of southwest and west. When the wind sets in from points between east and northeast, and the barometer falls steadily, a storm is approaching from the south or southwest, and its centre will pass near or to the south of the observer within twelve to twenty-four hours, with winds shifting to northwest by way of north. The rapidity of the storm’s approach and its intensity will be indicated by the rate and the amount of the fall in the barometer.” (*U. S. Weather Bureau.*)

may also be a result of this low temperature. It is dangerous for the pilot to fly with an ice-encrusted machine. The ice barnacles add greatly to the weight of the glider.

Weather Maps.—Since it is a difficult matter to forecast the weather, weather maps are extremely helpful. Trained

THE WIND AND THE WEATHER

observers forecast the weather, and the Weather Bureau publishes this information daily in the form of Weather Maps. These maps show the state of the atmosphere during the previous twenty-four hours. Solid lines connect all the points having the same atmospheric pressure, and dotted lines go through points having the same temperature. The direction of the local wind at each government weather or airline station is designated by an arrow. Symbols show whether there was clear or stormy weather, shading shows areas where rain or snow fell, and the location of "high" and "low" pressure areas is given (see Fig. 28). Official government weather maps and wind charts give valuable information to the pilot and may be obtained without difficulty from meteorological offices.

Weather Forecasts.—Exact forecasting requires experience and equipment, but the average man can form a rough estimate of what the weather for the next ten or twelve hours will be, by observing the clouds, the winds, the barometer, and the thermometer. A falling barometer indicates stormy weather. If the thermometer drops suddenly, fog may result. The formation of dew is a sign of fair weather. A "mackerel sky" indicates rain; bold white clouds, wind; and feathery clouds, good weather. These signs are not, of course, infallible.

Conclusion.—Glider pilots should be able to make good use of air currents of all sorts. The atmosphere itself is the best laboratory for meteorologists, and the glider the most sensitive instrument for experiment, more sensitive and more delicate, perhaps, than anything thus far designed by man.

CHAPTER VI

KITES AND WHAT THEY TEACH ABOUT GLIDING

KITES and gliders, although they differ in appearance, work on somewhat similar principles. Building and flying kites helps one to learn about the atmosphere and why the glider flies.

Points to Remember in Building a Kite.—There are five things which you must remember in building a kite. In the first place, your kite must have a broad surface which the wind can get hold of in order that it may supply sufficient lift. Second, the kite must be made of light materials, so that the force of gravity will not exceed the lift resulting from the wind, and pull the kite down to the ground. Third, the kite must be firmly bound together, so that it will not come apart in the air. Fourth, the kite must be bisymmetrical; that is, the resistance to the wind on one side of it should exactly balance that on the other side. Fifth, you must have some means of guiding the kite, so that it will not be blown about at the mercy of the wind, and finally, perhaps, lost altogether.

How to Build a Box Kite.—There are several kinds of kites, all of which are instructive to the student pilot; but the best sort to build is a box kite, since, although it requires considerable wind to fly it, it will ascend at a steeper angle than an ordinary kite.

To make a box kite of a good size, eight sticks of $\frac{1}{4}$ -by $\frac{1}{2}$ -inch spruce or pine, and two strips of cambric 10 by 65 inches, are necessary. Four of the sticks form the frame of the kite, and the others serve as braces (see Fig. 29). The

KITES AND WHAT THEY TEACH

strips of cloth are wrapped about each end of the frame, leaving a vent between them so that the wind can catch the kite more easily (see Fig. 30).

Fasten the ends of each band of cambric together, lapping the edges an inch, and securing them with glue and by stitching. The two resulting tubes of cloth must then be

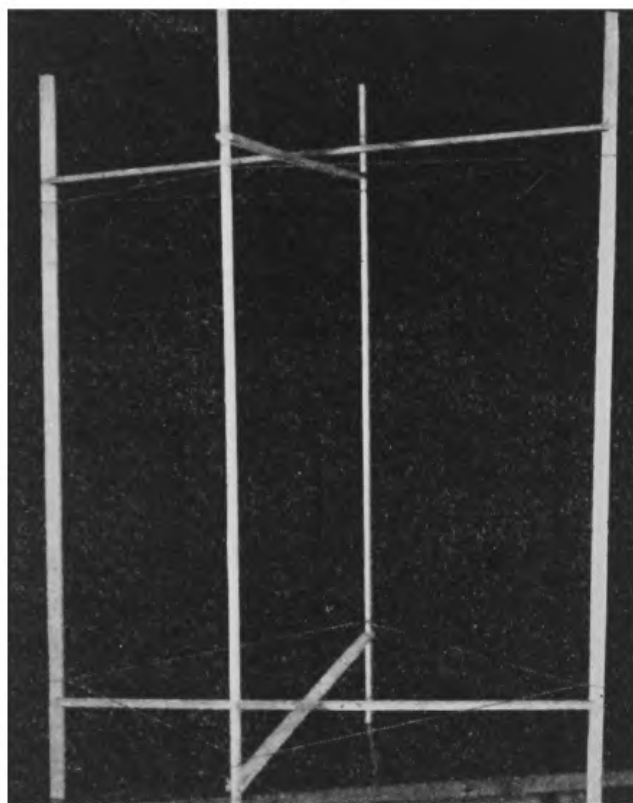

FIG. 29.—The wooden framework of a box kite. This photograph shows the completed kite without the cloth covering. In practice, the cross braces are not usually put in until the cloth strips have been glued to the corner sticks of wood.

fastened to the four sticks which form the framework of the kite. Cut each of these sticks 35 inches long. Put glue along one of the $\frac{1}{4}$ -inch sides of two of these sticks, and put them through both tubes of cloth, pulling the cloth taut between them, as in Fig. 31. When the glue is dry, fasten, in the same manner, two other sticks of the same length to the cloth midway between the other two sticks (see Fig. 32).

The braces must now be inserted to hold the kite open. Cut four sticks about 22 inches long for this purpose. The

GLIDING AND SOARING

braces should be long enough to stretch the cloth very tight over the framework. Notch each brace at either end, so that it will fit over the corner stick. It is well to wind the brace above the notches with strong cord in order to prevent

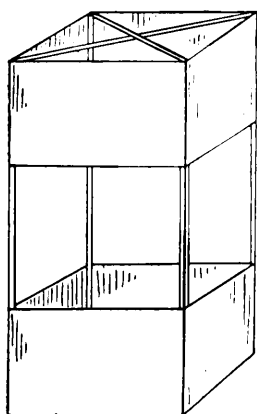

FIG. 30.—The appearance of the box kite when completed.

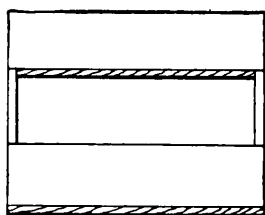

FIG. 31.—The cloth drawn taut over two corner sticks.

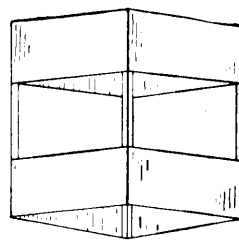

FIG. 32.—The cloth drawn tight over the other two corner sticks.

the wood from splitting (see Fig. 33). Put the braces in diagonally, across the ends of the kite, as in Fig. 34. The braces may be removed, and the kite folded up, when it is not in use.



FIG. 33.—Manner in which the end of the brace can be bound with string to prevent splitting.

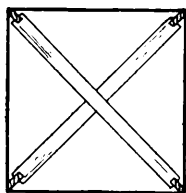

FIG. 34.—End view of the kite showing how braces are put.

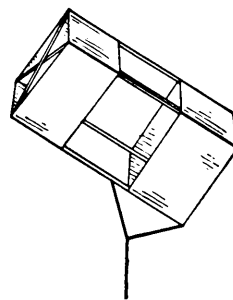

FIG. 35.—Position in which the kite flies. The harness is attached to the bottom of one of the corner sticks.

The kite string should be very long, and can be more easily handled if it is wound on a reel. In order to have the maximum control over the kite when it is in the air, the string should not be fastened directly to the kite, but should

KITES AND WHAT THEY TEACH

be attached to it by a harness. The harness is shown in Fig. 35. It consists of two short strings of equal length, fastened to one corner stick of the kite, and to the kite rope.

How to Fly the Kite.—Every boy knows how to fly a kite. It is a good idea to send up the kite from a hill, or from open ground where the wind is strong. You will notice that the kite flies readily in a high wind. If the wind is light, however, you will be obliged to run against it, in order to start the kite upward. The strength of the wind increases with altitude, and the kite will normally stay up when it has once gained height.

What the Kite Teaches about Gliding.—One of the primary principles of gliding is taught by kite flying: that is, that a glider, like a kite, will stay in the air as long as it has sufficient “flying speed.” Speed in this case does not mean speed over the ground, but speed through the air. You have noticed that, if the wind is low, you have to run with the kite to make it fly. But if the wind is strong, the kite will be moving through the air fast enough to stay up, even when you are holding it still over the ground with the string. In order to understand why the kite has speed through the air when it is making no progress over the ground, compare the kite with a swimmer. If the swimmer is going against the current of a river, he may have to swim very fast through the water in order that he may not fall behind the point on the bank where he started.

There are a good many other points of similarity between a kite and a glider. In the construction of a glider, the same principles of broad lifting surface, light weight, strength, symmetry, and control must be remembered.

Conclusion.—The glider is to some extent the outgrowth of the man-bearing kite. When you have built and flown a kite, you will be receptive to the idea that a glider flies when it has air speed, that it must be light and have broad

GLIDING AND SOARING

lifting surfaces, and that there must be some means by which it can be controlled. A glider launched by the auto or aircraft-towing methods is to all intents and purposes a man-carrying kite.

One of the main differences between a kite and a glider is that the former will fly continuously in a normal horizontal wind whereas the latter will not.

CHAPTER VII

WHAT THE GLIDER LOOKS LIKE

GLIDERS are far from uniform in appearance; some of them look in the air like poised birds, others like ungainly insects. Since few gliders have as yet been subjected to mass production, each constructor builds his ship after his own fancy. Therefore, a discussion of what the glider looks like must deal only with the general appearance of the more ordinary gliders.

Types of Gliders.—The majority of the gliders which have so far been built may be classified in various ways: first, as gliders and soarers; second, according to methods of control; third, according to number of wing surfaces; and fourth, as to their adaptability to training purposes.

Glider is the generic term designating any motorless heavier-than-air craft. Glider also is the specific term applied to the motorless heavier-than-air craft which maintains its speed solely by utilizing the force of gravity, without gaining much of any altitude by means of upward air currents. In contradistinction to glider in its specific sense is the term soarer or sailplane, a ship which, owing to higher aerodynamic perfection, is better fitted to gain altitude through the use of vertical currents of air. The difference in appearance between a glider and a soarer is one of degree of sensitivity: the glider is comparatively stable and heavy, with straight wings; the soarer is comparatively light, normally having wide span and tapering wings. The distinction between the two types is not a satisfactory one. Frequently, the one type merges into the other: the simple glider sometimes soars, or the plane

GLIDING AND SOARING



FIG. 36.—A soarer. This soarer was built by Bowlus, the great American sailplane builder.

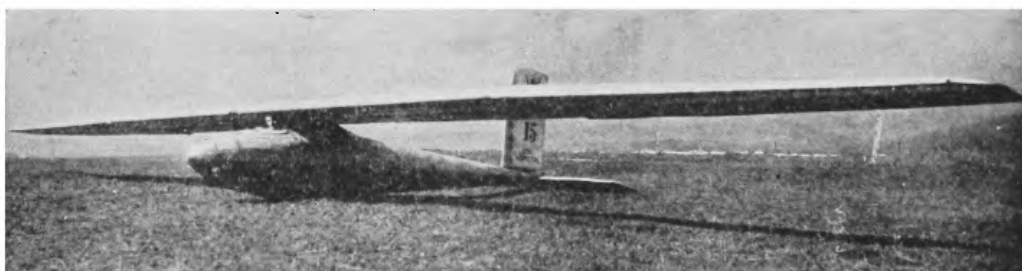

FIG. 37.—An advanced type of soarer. Perfect streamlining assures high efficiency to these ships.

WHAT THE GLIDER LOOKS LIKE

which has the appearance of a soarer is capable only of gliding flight. (Figures 36 and 37 show types of soarers.) It is necessary, therefore, to have some other means of classifying gliders.

Several different methods of control (*i.e.*, of maneuvering the plane when it is in the air) have so far been applied to gliders, such as:

1. Control by the swinging of the pilot's body.
2. Tail control.
3. Wing control.
4. Special control systems.

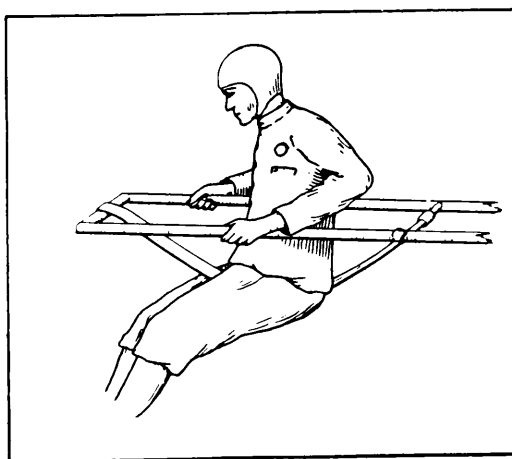

FIG. 38.—Method of controlling a hang glider.

1. A glider which is controlled by the swinging of the pilot's body is called a "hang glider." In a hang glider, the pilot sits astride a strap, or hangs from the wings by his arms, so that his legs hang below the underside of the body of the plane (see Fig. 38). By swinging his legs backward and forward, or from side to side, he can change the center of gravity of the glider, and thus control the direction which it takes. Hang gliders are not effective in high winds, require great skill and daring on the part of the pilot, and have little value as a means of training for motored flight, since airplanes have an entirely different method of control. The hang glider is now rarely used.

2. Gliders with tail control, supplemented by some wing control, are as yet the most efficient and widely used type.

GLIDING AND SOARING

This book will deal almost entirely with gliders of this kind. An objection raised to the tail-control glider is that it makes no self-adjustment to air currents, but is controlled entirely by the pilot, who is apt not to recognize the presence of a puff of wind until it has passed by.

3. Two general methods of wing control have been used: either the wings are made easily warpable, so that they will of their own accord make slight adjustments to air currents;

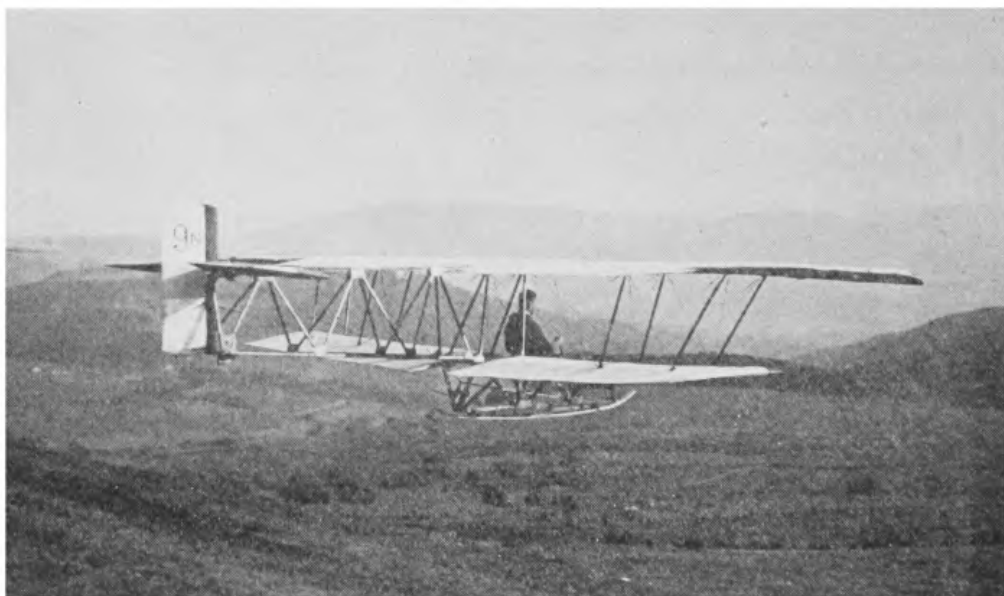

FIG. 39.—A biplane. Biplane gliders are not common. The additional wing surface does not add sufficient lift to offset the parasite resistance of the wires and struts.

or they are made to rotate about their main spars, so that each wing can move as a unit. This method of control has not yet reached a high enough degree of perfection to be widely used.

4. Various special control systems have been devised, such as those employed on the tailless type of glider.

Gliders with one wing surface are called monoplanes, those with two, biplanes (see Fig. 39), and those with three, triplanes. (By wing surface, the entire section of wing extending from both sides of the body of the glider is meant.) The wing surfaces of bi- and triplanes are usually

WHAT THE GLIDER LOOKS LIKE

placed one above the other, although they have (rarely) been set one behind another. Monoplanes are by far the most usual type. Triplanes are rare, since for a given wing



FIG. 40.—A secondary training glider. This glider is used by the student as soon as he has made a few flight attempts in a primary training glider. Although it will soar, it is less sensitive and more stable than a real soarer.

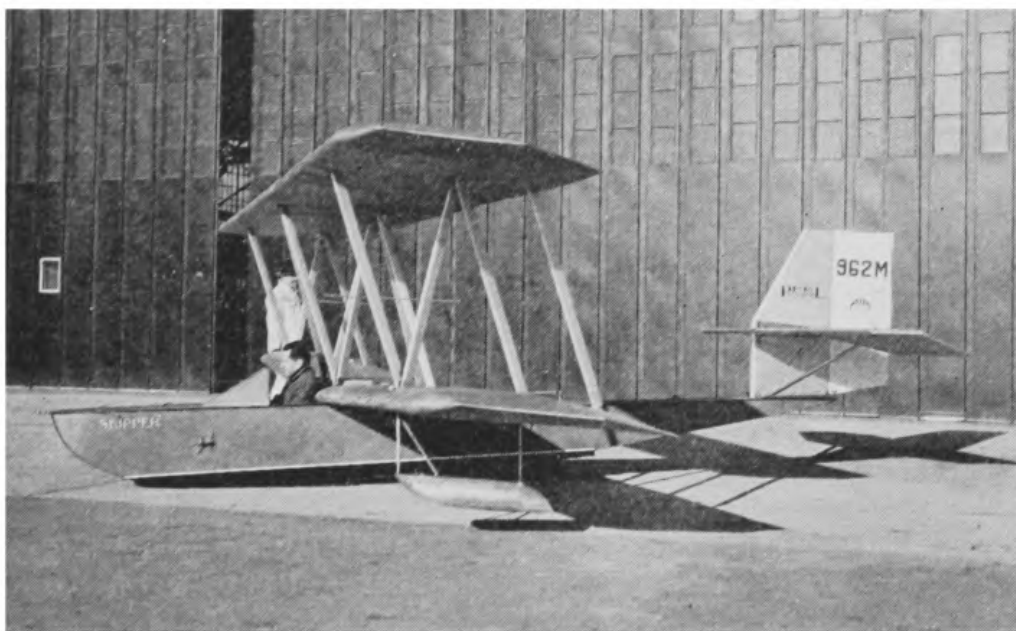

FIG. 41.—A water glider. This glider lands in the water on the fuselage. The pontoons under the wings help to preserve lateral balance.

area, the additional surface detracts from, rather than contributes to, the efficiency of the glider.

GLIDING AND SOARING

Several types of training gliders are manufactured in this country. The best known are the Primary and Secondary Training Gliders. These are both monoplanes, supplied with tail control, supplemented by wing control; and they are gliders, not soarers. The primary training glider is usually built with an open latticework body and square-tipped wings. The secondary training glider is more sensitive (it can be more easily soared), and has an enclosed body. Figure 40 is a picture of a secondary training glider.

Some gliders are built to land on and take off from the land; others to land on and take off from the water. The former are called land gliders, the latter, water gliders. Land gliders are by far the more common (see Fig. 41).

Parts of a Glider.—The most important parts of a glider are:

1. The fuselage, or body.
2. The lifting surfaces, or wings.
3. The controls.
4. The landing gear.

The Fuselage.—The fuselage, or body of the glider, is the framework which holds the cockpit, and to which the wings and tail are attached. The frame of the fuselage is built of wood or light metal, covered usually with air-dried, knotless wood. Cloth is frequently used as a covering. Duralumin, from both the framework and the covering of the fuselage, is stronger and as light as wood, but it is not often used since it is costly to repair and less easy to apply.

The Wings.—The framework of the wings is generally built of wood, although steel or duralumin is frequently used. This is usually covered by some strong, closely woven cloth. The cloth is then treated with “dope,” which permeates the fabric, pulling it taut over the framework, and making it impervious to water and air.

WHAT THE GLIDER LOOKS LIKE

The Controls.—The controls are the surfaces which guide the plane while it is in the air. The rudder and the elevators are two fins usually hinged to the rear end of the tail: The former is a vertical surface, and the latter a horizontal one. The ailerons are two flaps, normally hinged one at the end of each wing. Further information concerning controls is contained in Chap. IX.



FIG. 42.—A glider with skid and auxiliary wheels. This skid absorbs the shock of landing. The wheels do not add greatly to the parasite resistance, since they are set into the fuselage.

The Landing Gear.—The landing gear usually consists of a flexible skid or ski, running along the under side of the fuselage. This ski absorbs the shock which the glider receives when it reaches the ground. Landing wheels are not often used on gliders because they are too heavy, and because they make control difficult on hills (see Fig. 42). Nevertheless, balloon tires for gliders are gaining popularity. Some gliders are provided with footballs set into the fuselage to serve as wheels. This contrivance allows the glider to roll ahead after landing until it has expended its impetus. Skis, in place of the runner, facilitate the use of gliders in the winter (see Fig. 43), water gliders landing either directly on the fuselage, or on a float.

GLIDING AND SOARING

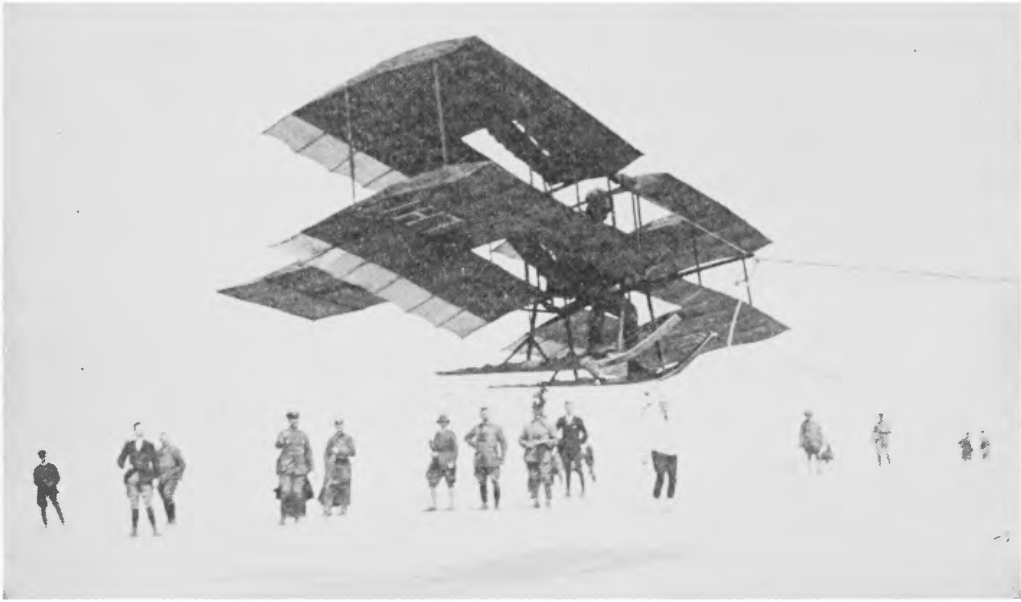

FIG. 43.—A glider with skis. This ship not only is equipped for winter flying, but also has a good deal of individuality of design.



FIG. 44.—Another type of soarer. The broad span and perfect streamlining, which allow the soarer to stay aloft so long, are visible here. This glider was flown by the German flyer, Klemperer, in Pennsylvania, for $15\frac{3}{4}$ miles.

WHAT THE GLIDER LOOKS LIKE

Size.—In general, gliders range in size from that of the smallest airplane, to that of six- or eight-passenger motored planes. But the proportions of a glider are very different from those of an airplane. Whereas the wingloading (*i.e.*, the amount of weight per square foot of wing surface) of the airplane varies, the glider always has a wide wing spread in proportion to the size of the fuselage. Thus, a soarer, with a span (*i.e.*, spread from one wing tip to the other) greater than that of a large transport airplane, usually has a fuselage barely large enough to carry the tail group, wings, and the pilot (see Fig. 44).

Conclusion.—In appearance, a glider resembles an airplane, much as a moth resembles a bird. The glider has large wings in proportion to the size of its body, it is delicate of structure, and it floats about on the wind in a leisurely manner.

CHAPTER VIII

WHY THE GLIDER STAYS IN THE AIR

THE glider stays in the air because it has lift. Lift is the force which, working against gravity, holds the plane in the air. Lift depends upon the speed of the glider, and the size and shape of the wings, or lifting surfaces of the plane. The reasons why the glider stays in the air are dealt with by the science of aerodynamics. Aerodynamics treats of the effects on the air of solid, moving bodies. Every pilot must have some knowledge of aerodynamic theory before he can fly his glider with maximum efficiency. Fairly complete treatments of this subject can be found in most recent books on aeronautics.

Speed.—Speed is the forward movement of the glider through the air. Speed is not necessary to support a boat in the water; it can float for an indefinite period of time in the same place, without sinking. But a section of air becomes temporarily used up, so to speak, as soon as it has supported a body, and the airplane must pass on to fresh sections of air to obtain continued support. For example, a bird would drop to the ground, if he were to continue flapping his wings in the same spot of air (unless, like the humming bird, he were especially adapted to this maneuver). Some migratory birds and airplanes fly in V-formation, so that the leader will not render useless the air through which the followers must fly.

It is easy to see how a propeller gives speed. Two forces, used in conjunction, serve the glider in lieu of a propeller: gravity and inertia. Gravity is a well-known force. When the glider is headed downward toward the earth, it is being

WHY THE GLIDER STAYS IN THE AIR

pulled groundward by gravity, which lends it speed. For example, it is gravity which allows the primary training glider to "slide downhill" after the plane has gained height from the take-off.

Inertia is a force as omnipresent as that of gravity, but not so commonly understood. It is the tendency of a body to remain in its state of rest, or to continue in the direction in which it is already moving. This tendency requires force to overcome it. Thus, the glider, when it has been shot off the side of a hill with a rubber cable, has inertia, *i.e.*, it tends to continue in its forward direction, until the opposing force set up by the resistance of the air overcomes its inertia. Were it not for inertia, the glider would go with the wind, instead of against it.

The Effect of the Wings on Air.—Speed alone is not sufficient to hold a body in the air. A bullet, no matter how great its speed at the outset, eventually falls to earth. The factor which complements speed in holding the airplane in the air is the lifting surface of the wings.

A wing is a type of airfoil, that is, a solid body designed to be projected through the air in order to produce a useful reaction. If a thin airfoil is passed through the air so that its surface is exactly in line with its path of motion, little reaction will be produced. But if the surface of the airfoil is set at a slight angle to its path of motion, so that the leading edge is higher above the ground than the trailing edge, two reactions will result: First, the air beneath and in front of the airfoil will be compressed by the moving body; second, the air above and behind will attempt to follow the foil and to fill up the space left by it; but, since the movement of the air is slow in comparison with that of the airfoil, a partial vacuum will be created. The compressed air, below, forces the airfoil upward and slightly backward. The partial vacuum above, pulls the airfoil upward and backward. The two forces resolve themselves into one force which acts at right angles to the surface of the airfoil

GLIDING AND SOARING

(see Fig. 45). That part of the force which pulls the foil slightly backward, thus hindering forward movement, is called "drag," while the upward component of the force is known as "lift."

The wings of a glider, in order to produce the reaction of the airfoil cited, are usually rigged so that their leading edges are slightly higher than their trailing edges. This angle of the chord of the wings to the longitudinal axis of the ship

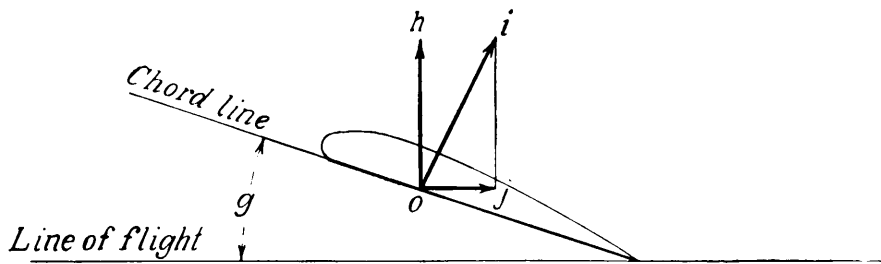

- g' Indicates angle of attack
- "oh" " lift
- "oj" " drag
- "oi" " resultant of both lift and drag
- "o" " center of pressure
- "oji" " lift, drag, and resultant triangle; where "ji" is drawn equal to "oh" and connects ends of resultant and drag lines.
Always a right-angled triangle so that if any two sides are known the other may be easily found.

FIG. 45.—Terms relating to wings. It is important to memorize these elementary definitions, since they are constantly used in aviation.

is called "angle of incidence." The angle of the cord of the wings to the ship's momentary path of motion through the air is called "angle of attack."

The Efficiency of Wings.—There are several ways of increasing the efficiency of wings, both in construction and in control. Wings are made, not flat, but, when viewed from the end, slightly convex, with the greatest curve near the leading edge. Thus, when the air strikes the wing, it is deflected upward, increasing the partial vacuum behind the

WHY THE GLIDER STAYS IN THE AIR

wing (see Fig. 46). The air escapes upward over the end of the wing, decreasing the effect of the vacuum. This effect is lessened in the more sensitive gliders, by building them with wide span (length of the wing) in proportion to the cord (breadth of wing) (see Fig. 47). Also, to increase general efficiency, wings are often tapered.

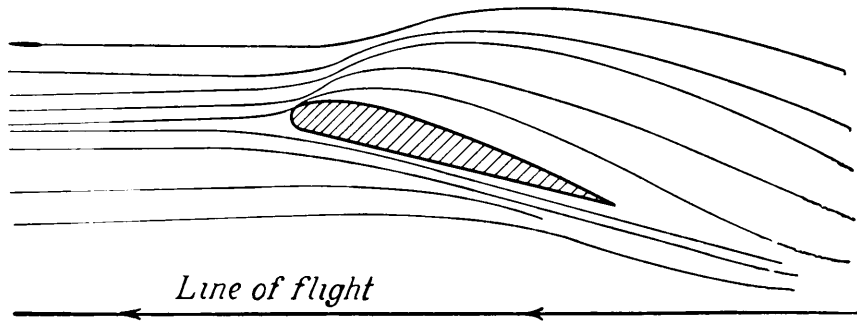

FIG. 46.—Path of air around a wing section. This shows how air is deflected upward sharply by the contour of the front part of the wing. More air is being pushed upward than is being deflected downward.

The second wing of an airplane (*i.e.*, as in a biplane) is less effective than the first wing, because one wing tends to interfere with the other. The upper one lessens the effect of the partial vacuum on the lower one.

Apart from these constructional methods of increasing wing efficiency, the pilot can make good use of the principles

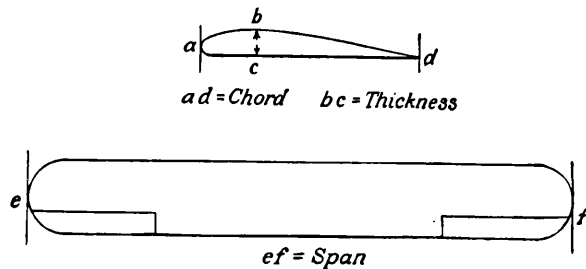
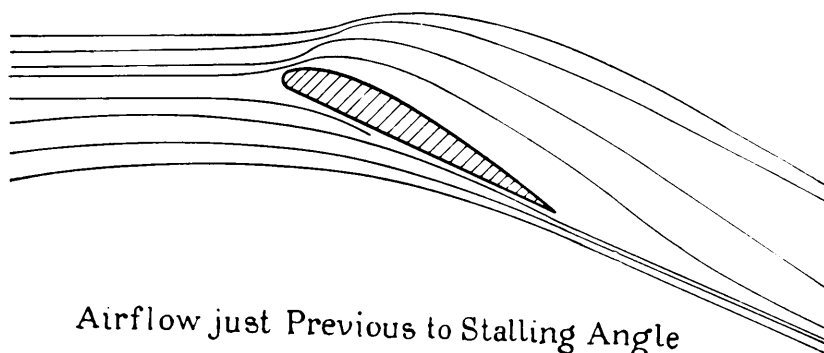

FIG. 47.—Span and chord. The relationship of the span to the chord is a matter of great importance in glider design.

of lift. When the angle of attack, *i.e.*, the angle between the path of motion and the chord of the wing, is increased somewhat, lift is also increased. It is by increasing the angle of attack that the glider is made to climb. When this

GLIDING AND SOARING

angle has been enlarged beyond a certain point, however (usually about 20 degrees), the drag becomes great, the air breaks up into eddies, reducing the effect of the vacuum,



Airflow just Previous to Stalling Angle

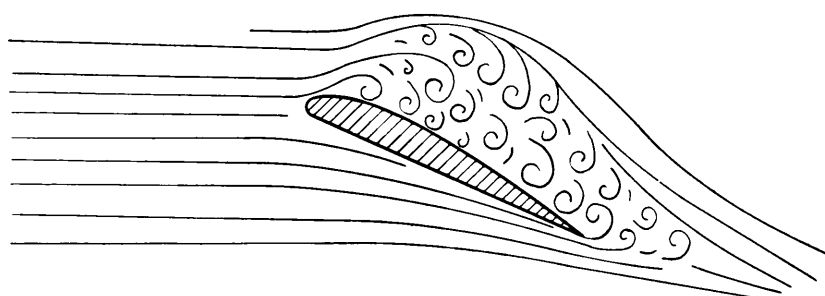

Airflow after an Increase of only a very Little beyond the Stalling Angle

FIG. 48.—The stalling angle. A slight increase in the angle of attack brings the plane from its angle of highest lift to an angle of very little lift. It is at this point that the stall occurs.

and the lift is suddenly reduced. This loss of lift is called “stalling” (see Fig. 48).

Streamlines.—A boat, when towed through the water, presents comparatively little resistance, on account of its shape. The water flows smoothly around it and closes in at the stern, helping to force the boat ahead. Air, like water, tends to follow certain lines when it passes around objects moving through it, and when the outlines of bodies are constructed so as to coincide with these lines, the body is said to be “streamlined.” The more perfectly the glider, or any of its parts, is streamlined, the more easily the ship will pass through the air (see Fig. 49).

WHY THE GLIDER STAYS IN THE AIR

Parasite Resistance.—It has been shown that the wings cause a certain amount of resistance, or drag. Likewise, other parts of the glider offer resistance. The resistance of all parts except the lifting surfaces is called “parasite resistance.” It is necessary to reduce parasite resistance

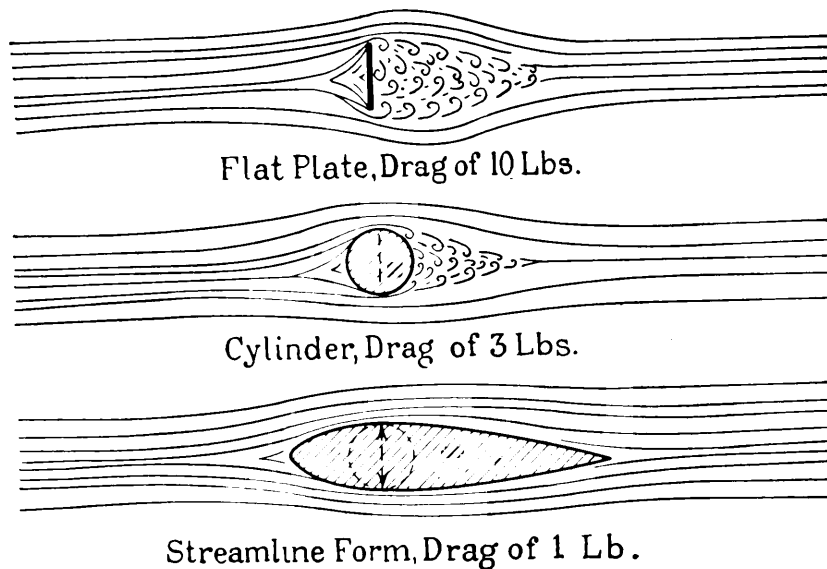

FIG. 49.—Resistance of different shapes to airflow. This shows airflow around different bodies and the approximate values of drag where they have the same diameter.

as much as possible, so that the progress of the plane may be little impeded. For this purpose, the fuselage is built in a good streamline shape. For the same reason, the number of struts and wires is reduced to the minimum in glider construction.

Conclusion.—The pilot who would become a builder of experimental gliders must have a thorough knowledge of aerodynamics. But every glider pilot must be familiar with the more elementary principles of the science.

CHAPTER IX

HOW THE CONTROLS WORK

THE controls are the surfaces which govern the speed, direction of flight, and, in general, the attitude of the glider. There are three sets of controls: the elevators, the rudder, and the ailerons. Before you start to fly, you must learn how to use these controls, since a glider without controls would be like a kite without a string.

The Axes of a Glider.—A glider has three axes about which it turns. From Fig. 50, you can see how the ship turns up or

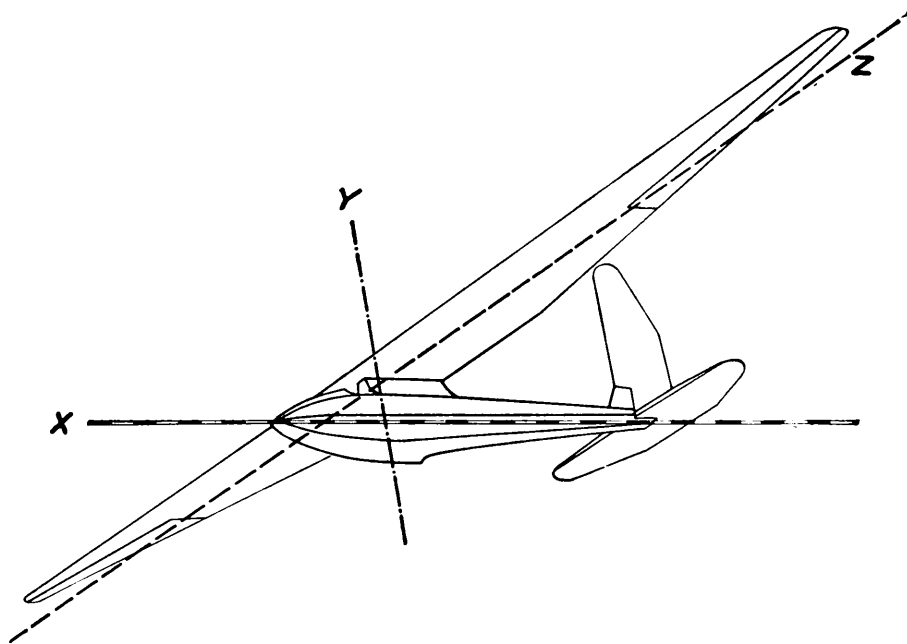

FIG. 50.—The axes of a glider. *X*, axis on which rolling or lateral movement takes place. *Y*, axis on which directional movement or yaw takes place. *Z*, axis on which pitch takes place.

down on axis *Z*, to the left or right on axis *Y*, and rolls sideways to the left or right on axis *X*. The movement on

HOW THE CONTROLS WORK

axis Z is called “the longitudinal movement” of the glider, that on axis Y , “the directional movement,” and that on axis X , “the lateral movement.” These three movements are known, respectively, as “pitch,” “yaw,” and “roll.”

The Elevators.—The elevators usually consist of two flaps, often hinged to a stationary fin, called the “stabilizer,” which projects from either side of the rear end of the fuselage. The elevators lie normally in a horizontal plane, but can be moved up or down on their hinges. The two elevators act as a single unit, both moving upward or downward at the same time (see Fig. 51). When they are raised,

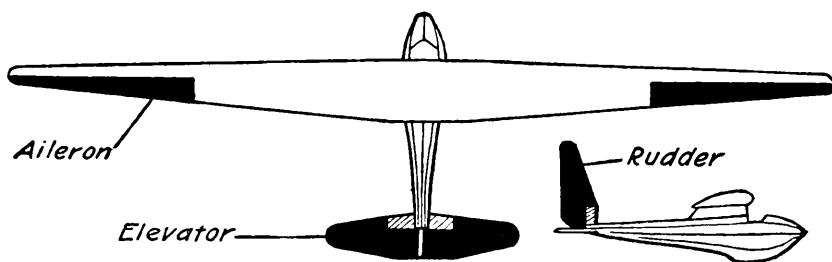

FIG. 51.—The control surfaces of a glider.

the supporting surface is reduced, causing the tail of the glider to go down, and the nose to go up in consequence. When they are lowered, the air forces the tail up and the nose down (see Fig. 52). Thus the plane can be made to climb or dive, or can be held level, by the movement of the elevators.

The Ailerons.—The ailerons are two horizontal flaps, hinged usually to the trailing edge of each wing. Although they sometimes run the whole length of the wing, they usually occupy from one-third to one-half of the total length of the wing (see Fig. 51). Figure 53 shows a wing-tip aileron of a still different type. Ailerons move up and down on their hinges in the same way that the elevators do, except that they are connected in such a way that whenever one goes up, the other goes down. When the aileron on one wing moves upward, the lift on that side is reduced, and that

GLIDING AND SOARING

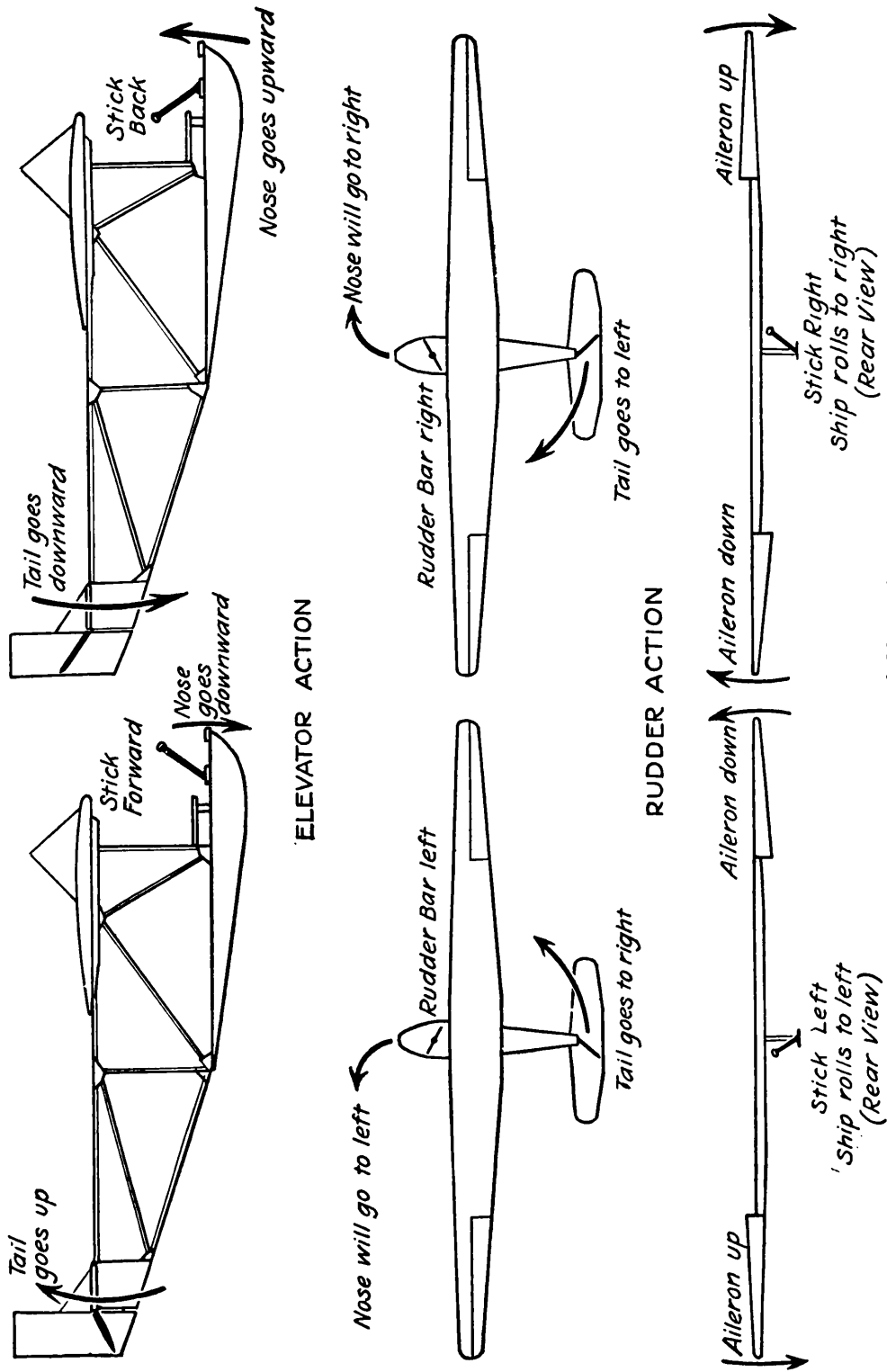

FIG. 52.—Elevator, rudder, and aileron actions.

HOW THE CONTROLS WORK

wing drops. Meanwhile, the aileron on the other wing has been depressed, the lift is increased, and that wing is raised (see Fig. 52).



FIG. 53.—Lindbergh placing a wing-tip aileron on a Bowlus sailplane. This aileron is an unusual type.

The Rudder.—The rudder is a vertical flap, usually hinged to a stationary fin at the end of the fuselage, and movable from side to side (see Fig. 51). The rudder and the elevators form the tail group, or empennage. The rudder acts in the same manner as the rudder on a boat: when it is moved to the left, the force of the air pushes the tail to the right, and there is a resulting turn of the nose to the left. The action of the rudder is shown in Fig. 52.

The Stick.—It is obvious that the pilot must have some convenient means of controlling the elevators, the rudder, and the ailerons from the cockpit. The stick controls the elevator and the ailerons. The stick projects from the floor of the cockpit between the pilot's knees. It is universally mounted, so that it can be pushed backward and forward and to the right and left. The pilot usually grasps it with his right hand. It is connected by wires with the ailerons and the elevators. A forward movement of the stick depresses, and a backward movement raises, the nose; while a movement of the stick to the left depresses the left, and raises the right wing, and *vice versa* (see Fig. 52).

GLIDING AND SOARING

The Rudder Bar.—The rudder is controlled from the cockpit by the rudder bar, just as the ailerons and elevators are controlled by the stick. The rudder bar lies in a horizontal plane, and is pivoted at the center, so that either end of it may be pushed forward. The pilot moves the bar with his feet, which rest on either end of it. The rudder bar is connected by wires to the rudder itself, so that when the left end of the rudder bar is pushed forward, the rudder, and consequently the plane, turn left; and *vice versa*. (These control movements are the exact opposite of those of the handle bars on a bicycle: *e.g.*, when you push on the right end of the handle bar, it turns the machine to the left.)

Sensitivity of the Controls.—The sensitivity of the controls depends, not only on the size of the control surfaces, but also on the speed with which the glider is traveling. If the wind is high, or if the ship is diving at a steep angle, the force of the air on the ailerons, the elevators, and rudder, will be great, and the plane will respond readily to control movements. This responsiveness is in direct proportion to the air speed. When the speed is high, the pilot must handle the stick and the rudder bar gently, and his movements of them must be slight. On the other hand, if the speed of the glider is low, the sensitivity of the controls will be decreased, and wide and sweeping movements of the stick and rudder bar will become necessary. The controls are then said to be “mushy.”

Owing to the relatively slow speed of a glider, all control surfaces must be much larger than in a powered airplane.

Conclusion.—The use of the controls is the basis of gliding. The movements of the stick and rudder bar must be reviewed in the mind, practiced on the ground, and tried in the air by the student pilot, until they become so instinctive to him that he can guide the action of the glider as involuntarily as he does his own arms and legs.

PART THREE

GLIDING

- CHAPTER X. Take-offs
- CHAPTER XI. Straight Flight
- CHAPTER XII. Stalls
- CHAPTER XIII. Landings
- CHAPTER XIV. Turns
- CHAPTER XV. Water Gliders

Part Three explains how the pilot should move the controls in order to effect the various maneuvers while gliding downward. In other words, it covers the subject of elementary training in gliding.

Chapter X describes the different methods by which the glider may be launched. Chapter XI tells how to maintain speed and stability while the ship is moving straight ahead. Chapter XII defines a stall, its uses and dangers, and the ways to bring about and to recover from a stalled position. The control movements necessary to bring about the successive steps in making a landing are listed in Chapter XIII. The way to make turns from a straight course, as well as the dangerous results of imperfect turns, are described in Chapter XIV. Water gliders are a comparatively recent development. Their appearance, general construction, and the phases of flight in which they must be handled differently from land gliders are described in Chapter XV.

CHAPTER X

TAKE-OFFS

A TAKE-OFF is the act of maneuvering the glider from the ground into the air. In order to take off, the glider must gain speed sufficient to give it lift and control. As the primary glider must, when in the air, rely largely upon the force of gravity for propulsion, so, when on the ground, the glider must gain speed from some exterior source. A ball will not go through the air until set in motion by the thrower's arm.

Choosing the Position for the Take-off.—The glider must be dragged to the part of the field from which the take-off is to be made. For this purpose the glider is usually set on small wheels. The following things must be considered when choosing the spot for the take-off: first, the direction of the wind; second, the steepness of the slope down which you intend to glide; and third, the freedom of the desired path from obstacles.

It is important, although not absolutely necessary, that you take off directly into the wind. One reason for this is that when you take off into the wind your wings obtain maximum lifting power sooner. If you should take off with the wind, you would be apt to be blown almost immediately to the ground. If you took off cross wind, the ship would be in danger of tilting sharply to one side, and your take-off would be poor. If, however, you take off directly into the wind, your air speed will be greater than your ground speed by an amount equal to the velocity of the wind (see Fig. 54). For example, having taken off into the wind, a glider may appear from the ground not to be moving at all; while

GLIDING AND SOARING

actually it is holding its own against the wind which rushes past it. The distinction between air and ground speed will become clearer if you consider the analogy of the swimmer who swims as hard as he can against the current, and yet cannot progress beyond the point on the bank where he started; his water speed is considerable, although his ground speed is zero.

In order that the take-off may be into the wind, gliding fields are usually chosen which face into the prevailing wind of the region, or which provide slopes in all directions.

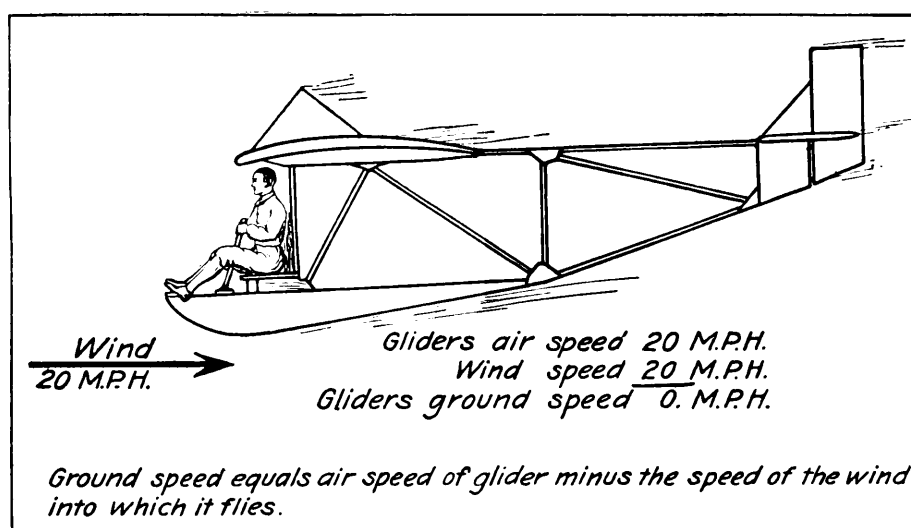

FIG. 54.

Beginners should make their early flights over level ground or along gentle slopes. Steep slopes may cause such violent upward currents that they make smooth gliding impossible. The path of the beginner's flight should be so near the ground all the way that the landing will be an easy one (see Fig. 55). Moreover, if the hill is long, do not take off from the top until you have become proficient enough to make comparatively long flights: it is easier to land on the level ground at the foot of the hill than on the slope.

It is imperative that your path of flight be free from obstacles. Trees, fences, boulders, electric wires, and other high obstructions are difficult to avoid after the flight has commenced; consequently, you must plan your course

TAKE-OFFS

before taking off. Never assume that you will go only a short distance—you may stay in the air longer than you expect, and encounter obstacles which you had ignored

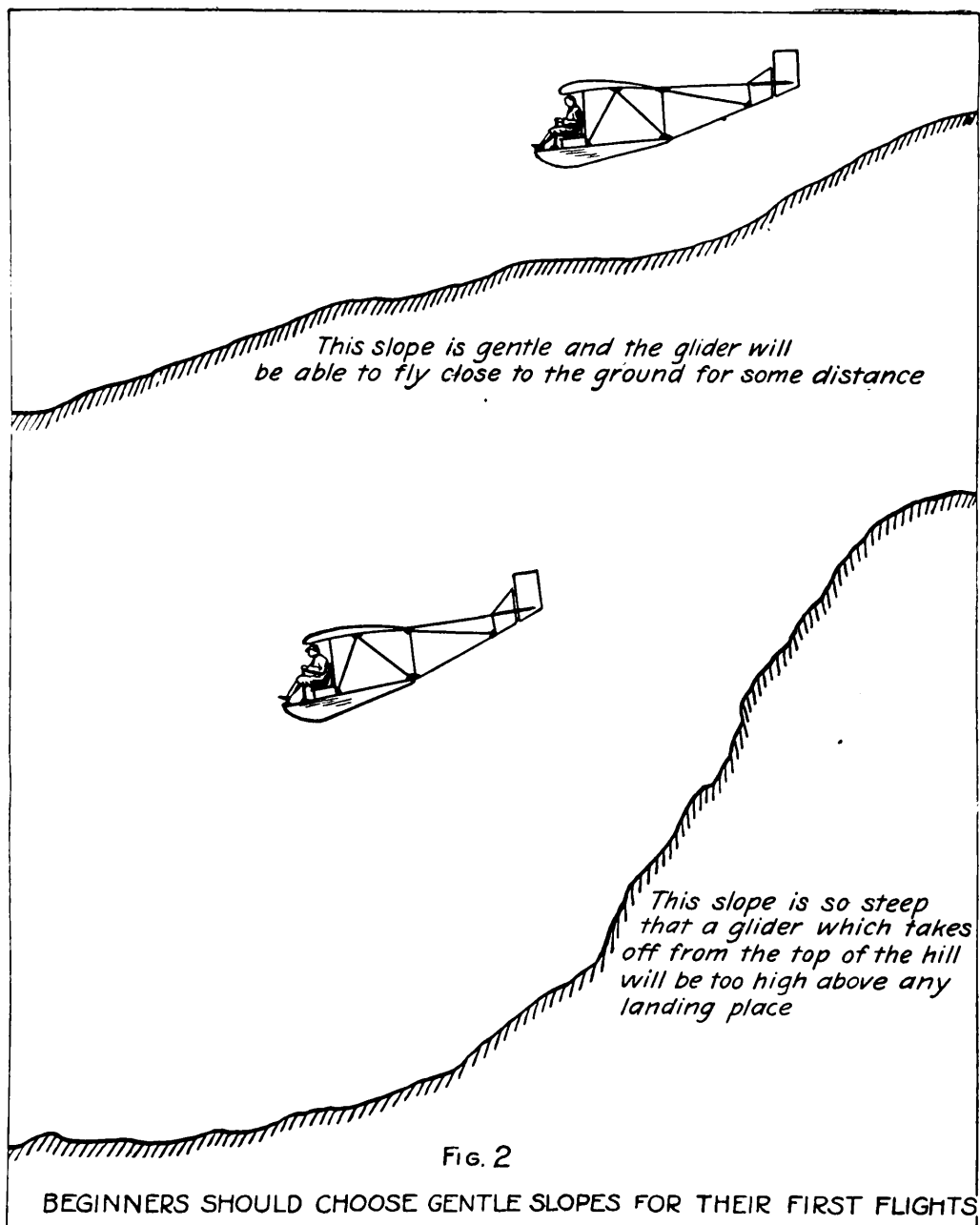

FIG. 55.

when planning your course. Even when you have become an able glider pilot, be sure to allow yourself a wide path; no matter how exactly you are headed into the wind, there is apt to be a certain amount of drift.

GLIDING AND SOARING

Inspection of the Glider.—Before taking off, make sure that the glider is ready for flight. The pilot who flew before you may have caused some injury to the ship which he did not repair. Inspect all nuts, wires, turnbuckles, etc. Move the stick and rudder bar to make sure that they effect the proper control movements: the wires connecting the stick and rudder bar with the control surfaces sometimes get mixed while the ship is being rigged, so that, for example, a forward movement of the stick moves the elevators up, instead of down.

Getting Ready for the Take-off.—When you get into the seat, fasten the safety belt around you. The safety belt is a strap, buckling around your waist, which holds you to the glider. You may be grateful for this belt if you hit an air “bump,” or make a poor landing. Feel for a rope which should be attached to the under-wing surface above you. (American ships are not always equipped with this rope, but most German ships have it.) Hold onto this rope with your left hand (the right hand grasps the stick) while taking off.

Before taking off, choose some object on the horizon directly in front of you. By keeping your eye fixed on this object, you will be able to maintain flight in the course which you have planned.

When you are ready to start, hold both rudder bar and stick in neutral. When you have had some experience you may find it practicable to pull the stick back a very little. This will raise the elevators slightly, ready for the climb. Much depends on the individual glider which you are flying.

Methods of Taking Off.—There are at least four different ways in which a glider can take off:

The oldest method is by running downhill. All hang gliders were taken off in this manner. The pilot, whose legs were, of course, free, held the glider with his arms, and ran

TAKE-OFFS

until flying speed was reached, and the glider rose from the ground of its own accord. Frequently, even now, gliders are taken off by a crew of men who pull the glider downhill by means of a hemp rope. This method is, however, a comparatively unsatisfactory one, since the glider is apt to be damaged by being dragged along the ground for too long a period. Not only is it a strain on the glider to pull it along the ground too far, but the pilot has difficulty in handling the plane before it gets into the air.

A second method of taking off, and one which is being used more and more extensively for training, is that of

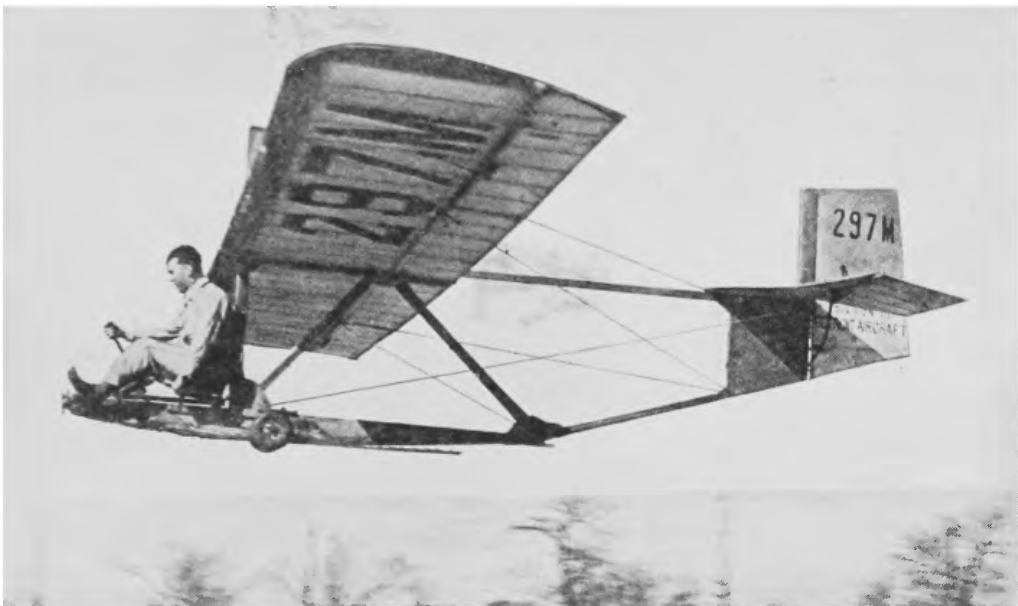

FIG. 56.—A glider built by the Gliders Division of the Detroit Aircraft Co.

towing the glider behind an automobile or motor boat. The glider is attached to the towing machine by a rope with a length of perhaps 200 feet. As the pilot becomes more experienced, the rope may be lengthened to 500 feet or more. The automobile, or motor boat, gathers speed rapidly in order to get the glider off as soon as possible. As soon as the glider gains sufficient forward speed (evidenced by the tendency of the glider to rise by itself), the pilot pulls the stick back gently. This brings the plane into the air. When it has taken off, the towing machine should

continue to travel fast, in order to continue the glider's "thrust" as long as possible. If the glider is going so slowly that it is forced to remain very near the ground for some time, the tow rope will drag, and flight will be very uneven. When sufficient altitude has been reached, the tow rope is released by a manual control and the pilot flies independently. *This method of take-off should be attempted by the student pilot only under the direction of a competent instructor (see Fig. 56).*

Experiments have recently been made in which gliders have been towed behind airplanes. The procedure here is, in general, the same as when the automobile does the towing, but it is far more intricate. The airplane's speed is of necessity very high, so that it is an unusually difficult task to pilot the glider. This, of course, should be attempted by only the most experienced pilots.

The Shock-cord Method of Taking Off.—The usual, and in most cases the most practicable method of take-off is one in which the glider is catapulted into the air by means of an elastic cable. This works in exactly the same manner as a sling-shot, where a rubber cord is stretched backward, then released, shooting a missile into the air.

The elastic cable consists of numerous strands of rubber held together by a braided covering. It should be from 80 to 200 feet long. At the center of it a metal ring is attached. This ring slips over an inverted hook on the nose of the glider, so that unless the cord is taut the ring falls off the hook (see Fig. 57). Each end of the cable is held by a crew of from two to six men. These men walk out ahead of the glider, carrying the cable forward so that it forms a V, with the point of the V at the ship's nose (see Fig. 58). The glider is usually held stationary by one man who sits on the ground and holds the tail, or by several men who hold a rope attached to the tail (see Fig. 59). The instructor holds one wing of the plane to preserve lateral balance, and, at the same time, gives instructions to the ground crew.

TAKE-OFFS

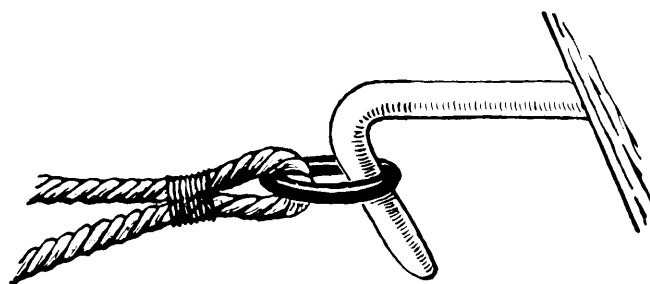

FIG. 57.—The ring and hook which connect the elastic cable to the nose of the glider. As long as the cable is taut the ring stays on the hook.

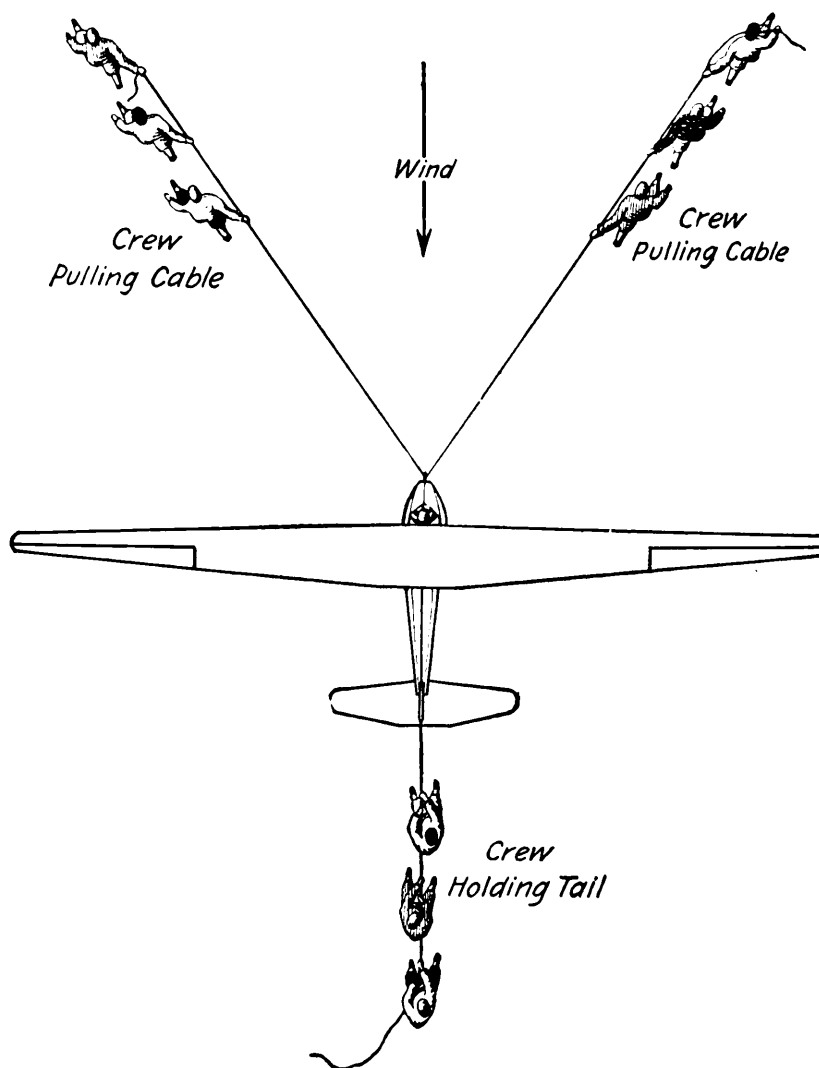

FIG. 58.—The catapult method of take-off. The crews stretch the elastic cable by running forward with it, while a few others hold the tail to prevent a premature take-off. When the cables are sufficiently tight a signal is given and the tail crew lets go with the result that the glider shoots into the air.

GLIDING AND SOARING

At the command "Walk!" the crew on the rubber cable takes about ten steps ahead. Then, at the command,



FIG. 59.—A side view of the glider in position for the take-off. Here the man can be seen who holds the glider stationary while the rest of the ground crew are running ahead with the rubber cable.

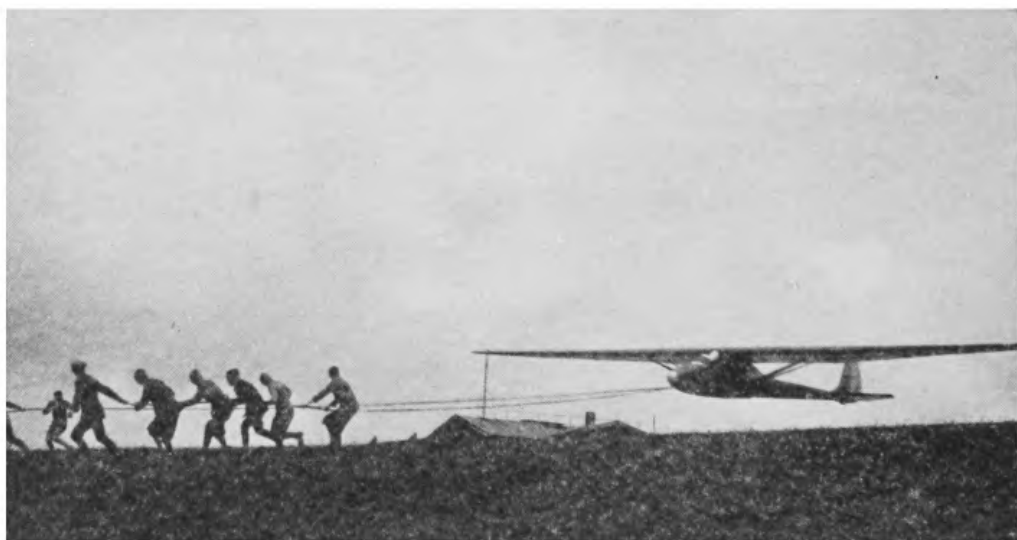

FIG. 60.—Leaving the ground. The crew at the tail, who held the glider stationary, have just released their grip. This soarer is taking off at the start of the record flight made by Robert Kronfeld in July 1929, when he flew 93 miles and gained an altitude of 7,080 feet above the starting point.

"Run!" the crew runs ahead another ten paces. Next, the instructor shouts, "Turn loose!" and the men at the tail let go, allowing the glider to be shot into the air (see Fig.

TAKE-OFFS

60). The elastic cord becomes slack, the ring falls to the ground, and the starting crew stops running (see Fig. 61). In a low wind, this method of take-off will launch the glider at a speed of about fifteen miles an hour. When the pilot becomes more expert the ground crew may be enlarged and may run ahead farther and at a greater speed, thus increasing the glider's speed. The crew may start to run when the cable is stretched to about 150 per cent of its



FIG. 61.—The shock cord falls off. Here the shock cord, no longer taut, has dropped from the hook on the nose of the glider. The pilot, at this altitude, is pushing the stick forward into neutral.

length and may turn loose when it is stretched to its capacity (about 200 per cent of its original length).

Sometimes the man, or men, at the tail are not used. The glider's own weight will hold it still until the shock cord has been stretched considerably.

Several precautions must be taken when this method of taking off is used: In the first place, the ground crew carrying the rubber cable must walk ahead so that the cord will form a perfect V, *i.e.*, so that the bisector of the angle of the V will be directly in line with the fuselage and the glider's path of flight. If one end of the rubber cable is carried too far to one side, the tail of the glider will be

GLIDING AND SOARING

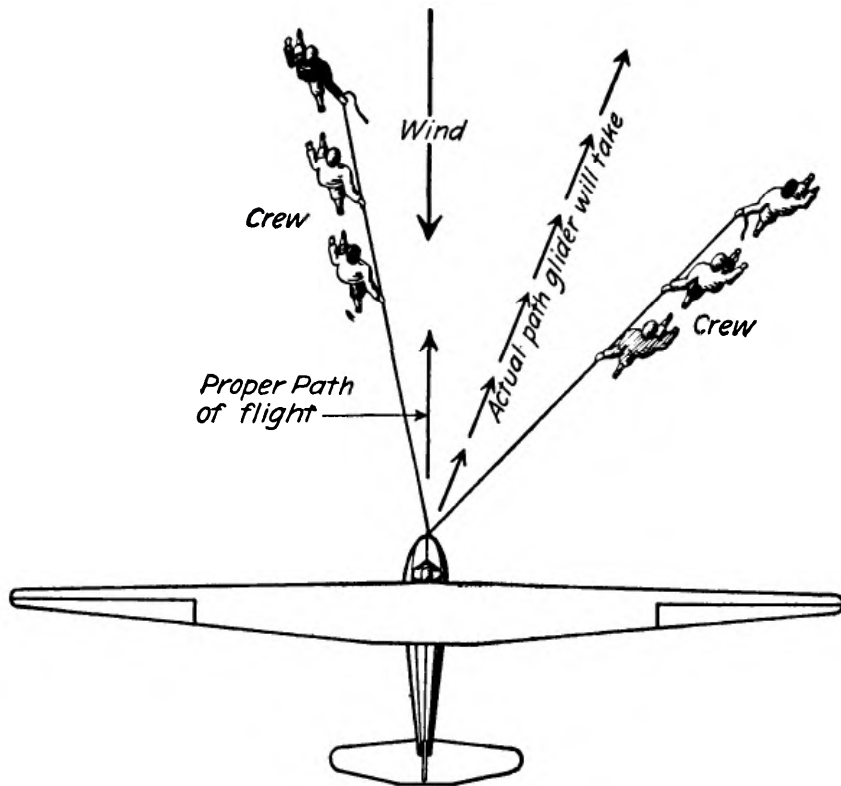

FIG. 62.—The ground crew should always carry the elastic cables in a perfect V. This diagram shows what will happen if the ground crew does not pull the cables properly.

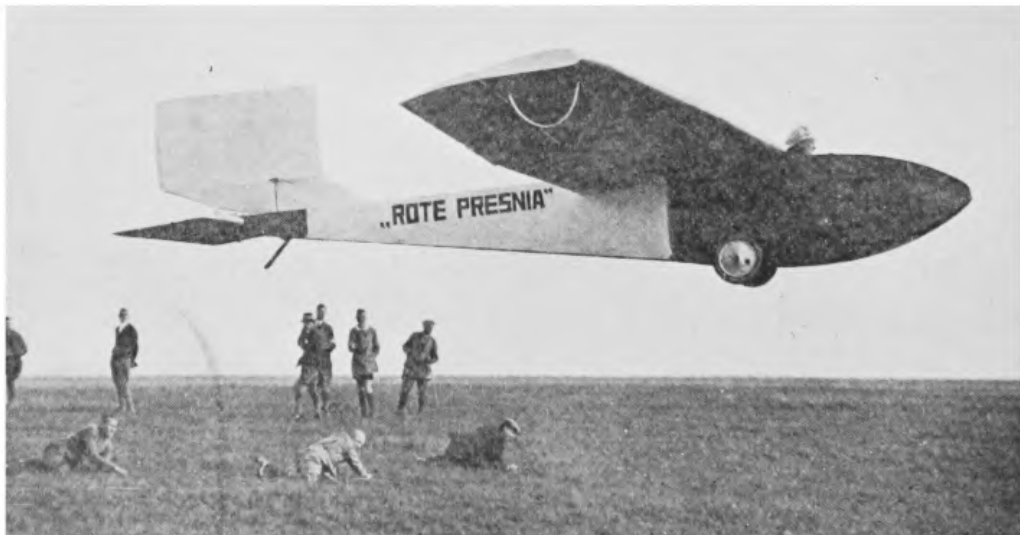

FIG. 63.—These men have ducked so that the glider will not strike them. This Russian soarer is of interesting design. Notice the size of the rudder, and the wheels.

TAKE-OFFS

swung about during the take-off, and the ship will not start out along its intended path of flight. In order that the ground crew may stretch the cord to form a perfect V, it is a good idea to mark places on the ground toward which they must run (see Fig. 62). Moreover, after the command, "Turn loose!" has been given, the men carrying the cable should duck away from the glider's path, so that the plane will not hit them if the take-off is poor (see Fig. 63). Sometimes the ring does not fall off the hook immediately. In this event, it is necessary for the pilot to push the stick forward, dropping the nose for a moment, and then to pull the stick back again. The ring usually drops off without further difficulty. An experienced pilot can tell when the hook drops off from the action of the ship.

Some automatic launching devices have been tried, but they are still experimental.

Conclusion.—A take-off is not a difficult feat, but the success of the entire flight depends to a great extent upon its proper execution. The student should have a well-trained ground crew, and should himself be thoroughly acquainted with the principles of the take-off, before he attempts his first glide.

Four Things to Remember about the Take-off:

1. Take off into the wind.
 2. Be sure your course is free from obstacles.
 3. Keep the stick in neutral during the take-off.
 4. The first flight is never so startling as you expect.
- Keep cool!

CHAPTER XI

STRAIGHT FLIGHT

AFTER the take-off, the pilot's object is to keep a primary glider in the air as long as possible. He usually does this by flying in a straight line (see Fig. 64). Straight flying is more difficult than one might expect.



FIG. 64.—A secondary training glider in straight flight. The normal lateral and directional position of the glider in straight flight can be seen in this photograph.

Recovering from the Take-off.—When you are off the ground, and have cut loose from the towline or shock cord, hold the stick in neutral (see Fig. 65). If you hold the stick back, the ship will climb, and will soon lose flying speed. When a glider stalls in a climbing position there is a tendency for it to fall over on one wing. Until you know from experience how to handle the elevators, it is better to keep the stick in neutral during the take-off (see Fig. 66). The exact position of the stick depends upon the ship and upon conditions.

Keeping a Straight Course.—Keep your eyes fixed on the point on the horizon which you have already chosen for a

STRAIGHT FLIGHT

sight, in order that you may not deviate from your intended course. You keep the glider headed straight by left or right

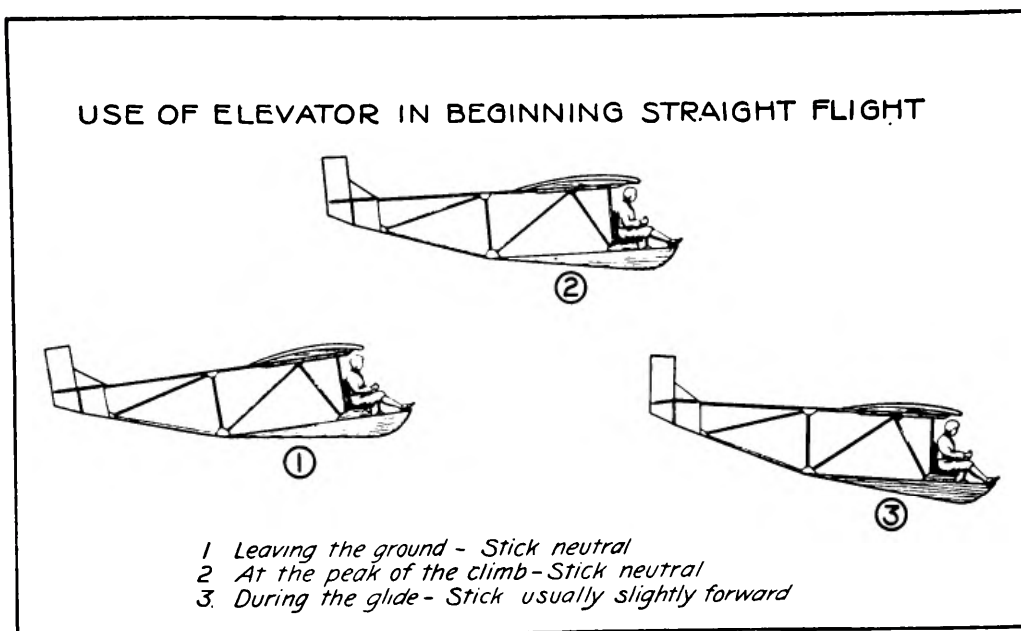

FIG. 65.



FIG. 66.—The climb. The glider has been shot into the air by the shock cord, and, at a good speed, is gaining altitude.

rudder as the case warrants. Your first few flights will, of necessity, be short ones, and you will have little trouble in preventing yawing. You will, however, have to be sure that

your wings remain level, or your landing will injure the plane.

When your flights become extended, however, and you are able to stay in the air nearly thirty seconds, you will find all the controls more necessary. Whenever one wing drops, the plane will normally swerve to that side. To counteract this, apply up aileron and opposite rudder; *e.g.*, if the left wing drops and the nose turns to the left, move the stick gently to the right, and push forward the right end of the rudder bar. Always use rudder and aileron proportionately. A secondary training glider is usually more sensitive than the primary training glider and these movements will be accentuated in it.

In spite of the temptation to look at the wings to see whether or not they are level, the best plan is to keep your attention concentrated on the sight chosen in front of you. You will soon get the "feel" of the plane, so that you will know instinctively whenever one wing drops below the other.

Angle of Glide.—The angle of glide is the angle which the glider's path of flight forms with the horizontal. A very sharp angle of glide is called a dive, and makes the glider go toward the ground at a high speed. A very flat angle of glide, in which the ship's path of flight is almost parallel to the horizontal, slows up the speed and tends to result in a stall. The most effective angle of glide is between a dive and the stalling point. At this angle, the glider loses altitude at the minimum rate (see Fig. 67).

Several factors affect the angle of glide. When the glider's air speed is high, the ship will not stall at even a comparatively flat angle. The proper angle of glide varies with different gliders. The primary training glider is heavy in proportion to its span, and, therefore, its angle of glide is much steeper than that of a soarer. The amount of wind is, of course, one of the most important of these factors.

After the take-off, the plane will begin to lose speed gradually, and the angle of glide must be made relatively

STRAIGHT FLIGHT

sharper in order to maintain air speed. During the take-off you have kept the stick in neutral. It is now necessary to put it in such a position that the ship will assume the correct angle of glide (see Fig. 67). This position

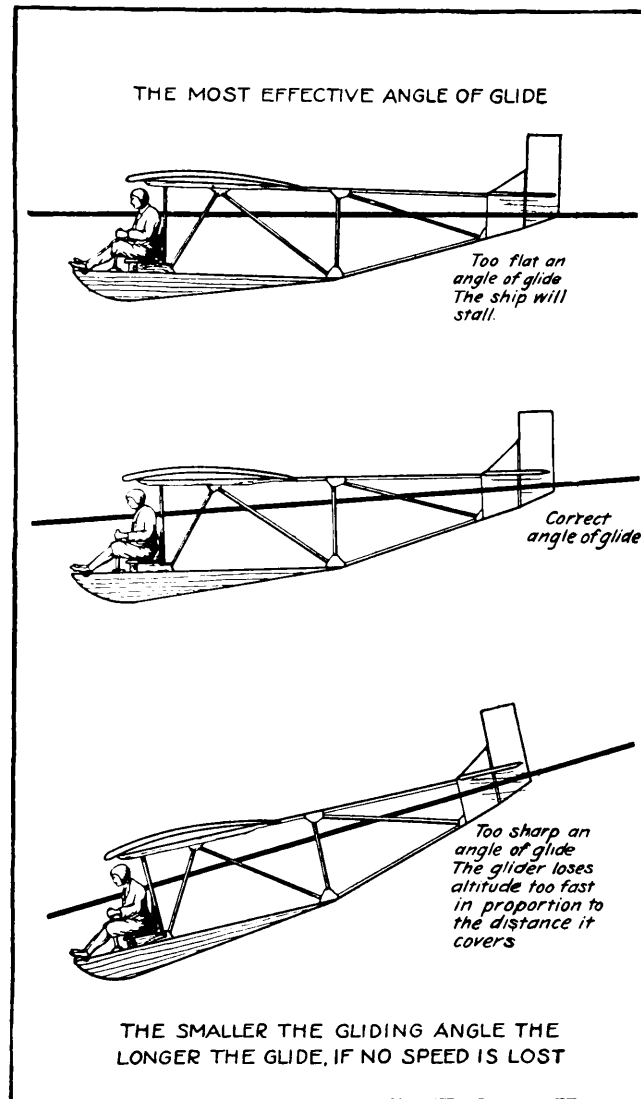

FIG. 67.

is, in some gliders, a little ahead of neutral. Do not push it ahead too far—too steep a glide will give you insufficient time to pull out of it and keep the glider from landing nose down. In your first few take-offs, you will be obliged to push the stick forward rather soon. Later, however, you will be launched into the air at a greater speed, and the impetus

GLIDING AND SOARING

from the take-off will be more lasting. It will then be possible to hold the stick in neutral for a longer time before pushing it ahead for the glide.

You can learn only by experience what is the most effective angle of glide, and when to push the stick ahead of neutral.

Handling the Controls in Straight Flight.—The promptness with which the glider responds to control movements depends upon the ship's air speed. At a high speed, for instance, the pressure upon lowered elevators is greater than it is at a low speed. Immediately after the take-off, the controls are sensitive, and only slight movements are needed. But, as the ship loses momentum, the controls become less effective. Thus, near the end of the flight, only a broad sweep of the stick to the side will bring up a lowered wing.

Nevertheless, the tendency of beginners is to over- rather than to under-control. Unless your control movements are steady, the movements of the ship will be jerky. You may imagine that the stick is a rigid lever fixed to the glider, and that you must press the ship in the right direction with this locked lever. In order to make control movements smoothly, try to sit in a relaxed position.

Bumps.—"Bumps" are atmospheric disturbances caused by conflicting currents of air. When the glider strikes a bump, it rises and drops again suddenly, or careens, as a vessel does when it encounters an unusually large wave. Bumps are common whenever the wind is high. If you strike a bump, do not think the irregularity of your flight is due to your poor maneuvering. No loss of control will result from a bump so long as flying speed is maintained.

Path of Flight.—Just as the plane's air speed is an entirely different thing from its ground speed, so its path of flight is independent of its progress over the ground. Path of flight

STRAIGHT FLIGHT

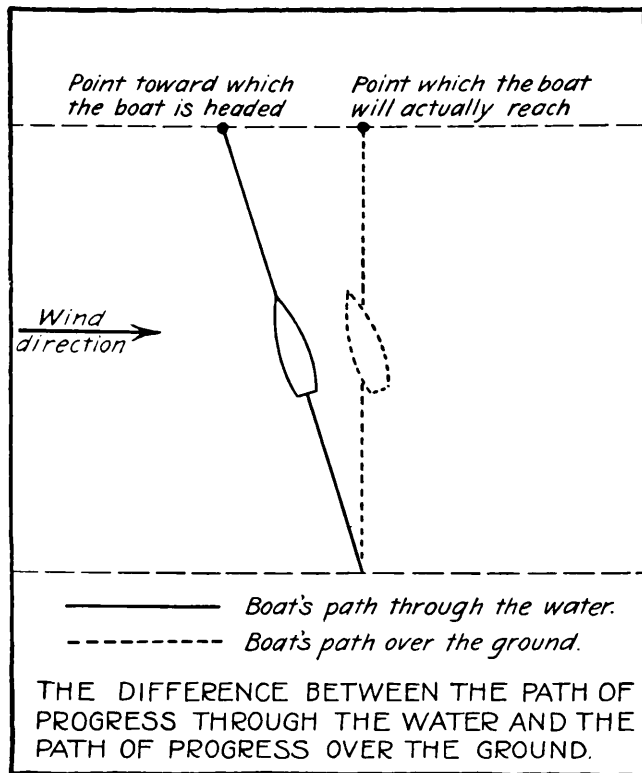

FIG. 68.

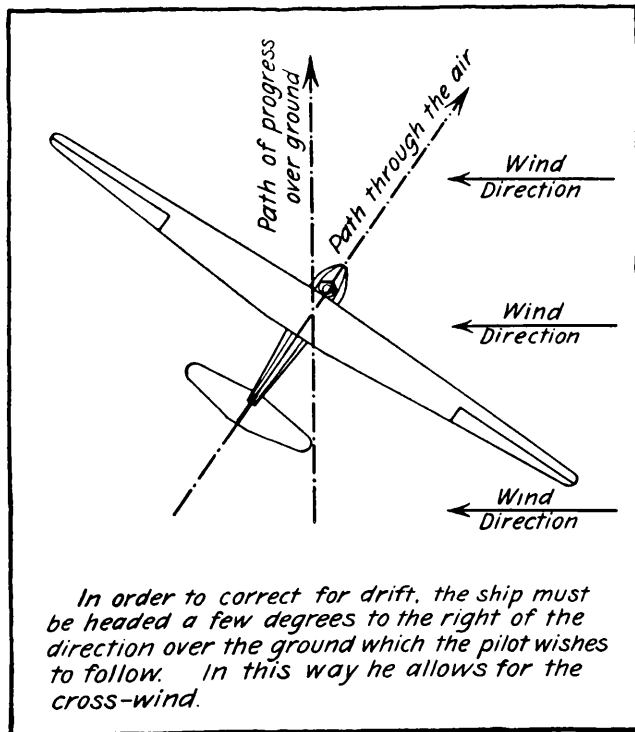

FIG. 69.—Crabbing.

means the course which the ship takes through the air. The boat going across the river does not point its bow in the direction in which it is actually going over the ground (see Fig. 68). In the same way, the glider, if it turns from its original course directly into the wind, must allow for "drift" in order to maintain straight flight. Thus, if the pilot wishes to fly toward a tree on the horizon and the wind is coming from his right, he must head slightly to the right of the tree. The glider will appear, from the ground, to be going sideways, or "crabbing" (see Fig. 69).

It is dangerous to attempt to glide across the wind, however, and you will have no occasion to do so at first. If a take-off is poor, so that you are not going straight into the wind, you must turn until you are doing so.

How to Avoid Obstacles.—If you do not follow the course originally planned, or if you glide farther than you expected, you may encounter obstacles. In this event, it may be possible to turn aside to avoid the obstruction. Frequently, you may be able to dive slightly and land before you reach it. You must use good judgment. If you find it necessary to climb over the obstacle, remember one thing: speed is necessary in order to climb. Whether you attempt to climb or not will depend on the height you are above the ground and the chance you have of diving first, for to gain speed you must dive. If you pull the stick back and climb too soon, you may be obliged to dive a second time, in this way losing your impetus and being unable to fly clear. Therefore, it is imperative not to pull the stick back until you are almost upon the obstruction (see Fig. 70).

Gliders Flown as Kites.—Gliders are not always cut loose from their towlines. In this case, the automobile, motor boat, or airplane, simply continues to move ahead with the glider in tow. The tow rope is usually carried on a reel, and let out gradually, sometimes to lengths of 1,200 feet. When towed by boat or car, the glider is usually able to attain an altitude half as great as the length of the line.

STRAIGHT FLIGHT

But this method of flight is comparatively difficult, since the speed of the towing machine must be very regular, and since the towline is apt to slacken and then suddenly become

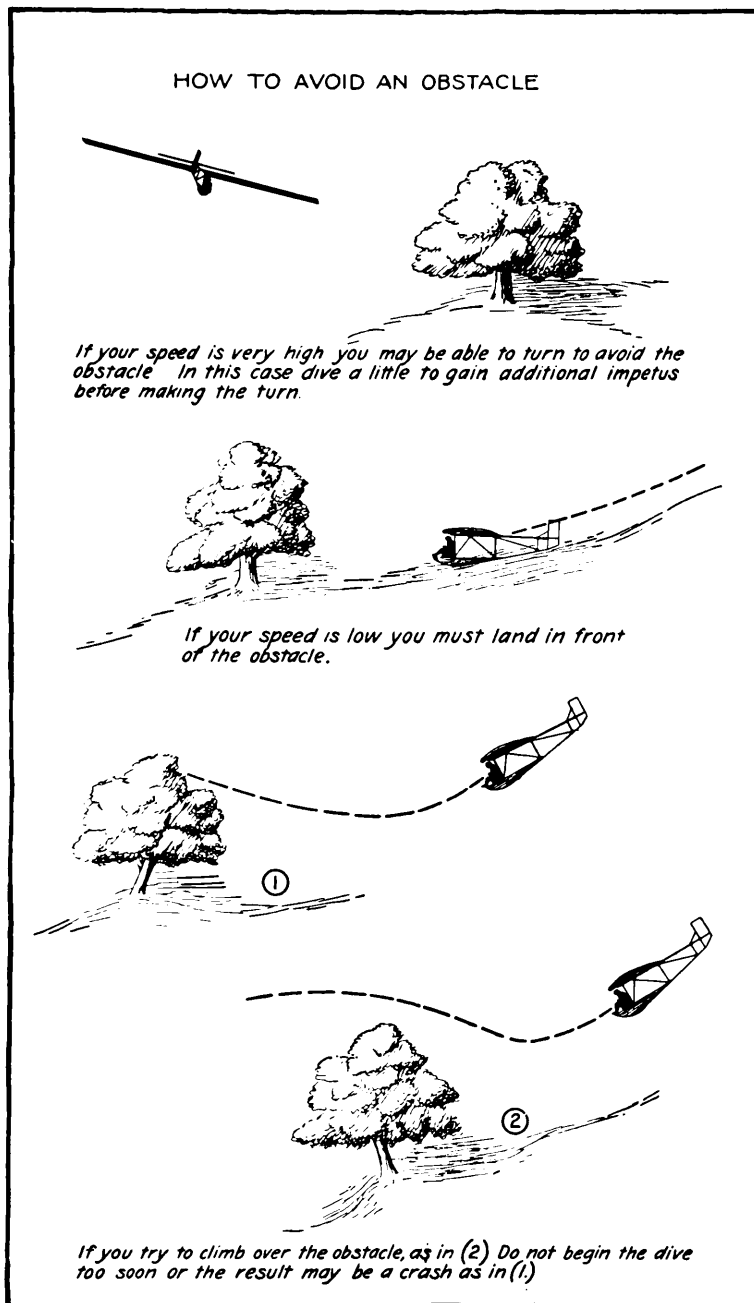

FIG. 70.

taut again. The shock of the sudden tightening of the line may be partly offset, if the glider's pilot dives for a moment to gain speed.

GLIDING AND SOARING

Towing by airplanes, except for the purpose of launching the glider, has been forbidden by the Department of Commerce. By special dispensation, however, Captain Hawkes made a record towed flight from coast to coast.

Conclusion.—Straight flight is easy in theory but it becomes more and more difficult in practice as flights grow longer. To be proficient, even at straight flight, experience is necessary.

Five Things to Remember about Straight Flight:

1. Primary training gliders are comparatively stable. If you do not do anything violent the glider will probably land you safely.
2. Keep your eyes on the chosen sight on the horizon.
3. Do not pull the stick back too soon when about to climb over an obstacle.
4. Keep your gliding angle such that you have control of your ship but are not wasting altitude.
5. Keep flying speed!

Cautions to Motored-plane Pilots:

1. Do not try to climb. You cannot “give her the gun.”
2. Do not dive too steeply. Gliders are not built like pursuit ships.

CHAPTER XII

STALLS

A **STALL** is the condition resulting from the loss of flying speed. When the glider stalls, the controls become ineffective. Stalls should be avoided, since loss of flying speed causes the ship to settle earthward, while the maintenance of sufficient height above the ground is one of the main objects of the pilot. Nevertheless, stalls are normally effected in making the glider drop gently to the earth for a landing, and you should understand when to use and how to avoid them.

When the glider loses flying speed, the force of gravity overcomes the lifting force. When this occurs the ship stalls and starts to fall. At the moment of stalling, the glider's nose is always pointed higher than the path of flight, as Fig. 71 shows. Although the ship may stall and start to fall in almost any attitude (whether it is climbing, gliding, or turning), it always assumes a diving position eventually. It does not dive sharply, however, since the glider is light. The nose, containing the pilot's weight, is the heaviest part of the plane, and is the first to fall. When the glider dives, it gathers momentum, until flying speed is regained.

Danger of Stalls.—When a motored plane stalls, the result may be serious, often disastrous. This is because an airplane is heavy, and has high flying speed and small wing area, so that it sometimes does not have time to regain flying speed before it crashes onto the ground. A glider, on the other hand, is light and, if properly handled, can usually be brought out of a stall after a drop of no more than 12

GLIDING AND SOARING

to 15 feet. Even if the glider stalls too close to the ground to be able to recover, the crash would probably not injure the pilot, although the ship itself might be damaged.

Spins.—The stalling of a motored plane is dangerous, moreover, because, unless checked, it may result in a spin.

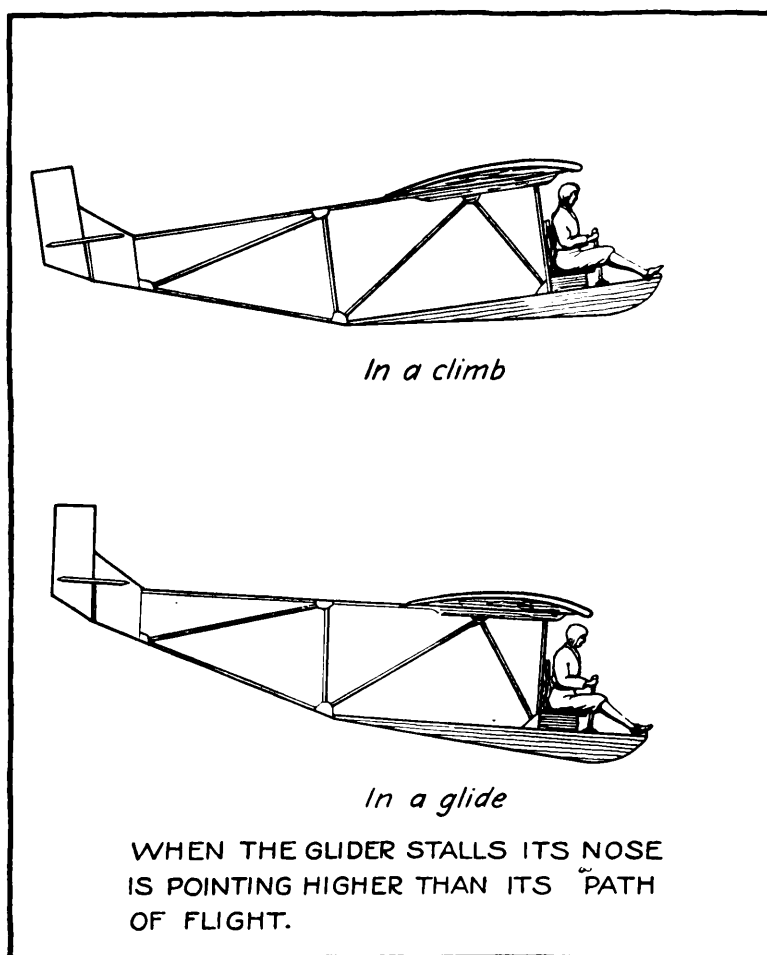

FIG. 71.

A spin is the rotation, about an axis almost perpendicular to the earth, of a stalled plane which is falling, nose downward. Spins, however, do not often occur in gliders. Further information about spins is given in Chap. XIX.

Causes of Stalls.—Stalls may result from several conditions, which can be summarized as follows:

STALLS

1. *In Climbing.*—A glider stalls if it tries to climb longer than its forward impetus warrants. As a matter of fact,

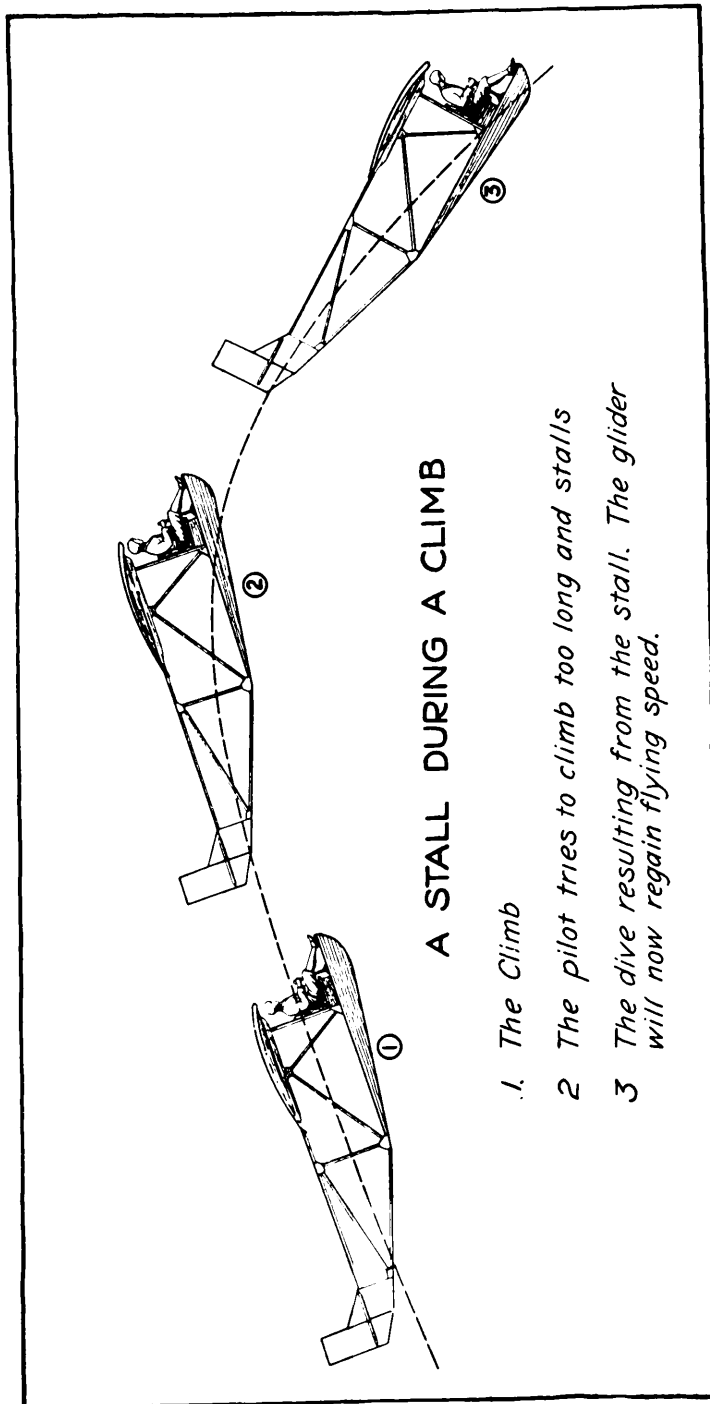

FIG. 72.

primary gliders rarely climb at all. Until you begin to soar, you will do little climbing. It was to avoid the danger of stalls that you were told that it was better not to climb

GLIDING AND SOARING

at all during the take-off, but to hold the stick in neutral when being launched into the air (see Fig. 72).

2. *In Gliding.*—If the ship's angle of glide is too flat, the downward speed will not be sufficient to maintain flying speed. Most gliders have enough lift so that it would be difficult for them to stall during a glide (see Fig. 73).

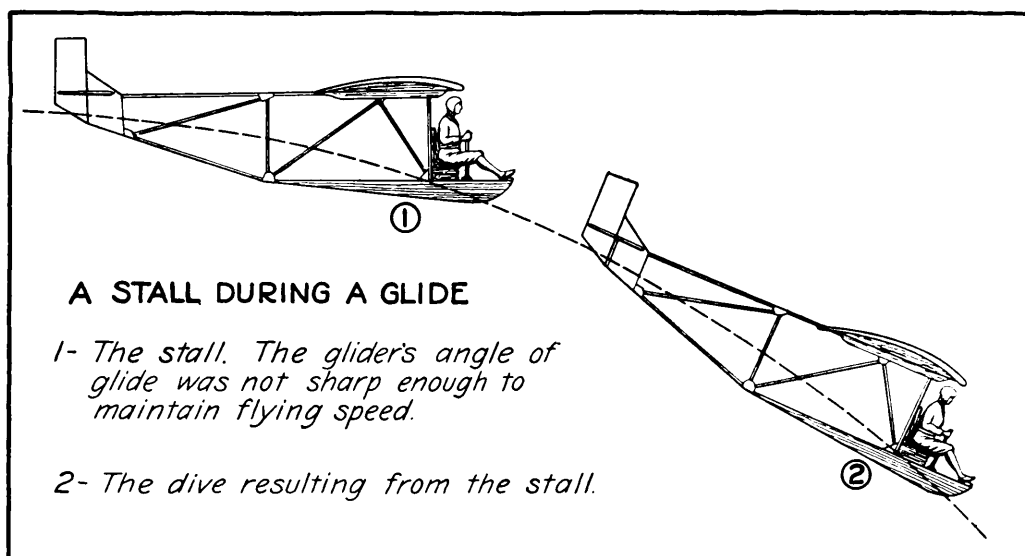

FIG. 73.

3. *In Turns.*—If a glider is skidded on a turn this increases the glider's drag, and consequently decreases its speed, which may result in a stall.

You can see from Fig. 71 that when the glider stalls its nose is pointing above its path of flight.

How to Recover from Stalls.—As soon as a stall is evidenced by the inefficiency of the controls, push the stick forward. When flying speed is lost, it can be regained only by diving the glider. As soon as the nose of the ship begins of its own accord to drop, the lowered elevators will become increasingly effective, forcing the plane into a steeper dive. When the glider has gathered speed, pull the stick gradually back to neutral.

STALLS

When the ship is climbing, stalls are the most dangerous. The glider, having lost its speed while in a climbing position, tends to slide backward. This tendency is, however, offset almost immediately by the weight of the nose, which changes the ship's angle of attack. A vigorous take-off launches the glider into the air high enough so that recovery from a stall is possible.

A stall due to too flat an angle of glide can be corrected almost immediately by pushing the stick forward.

When a glider stalls during a turn, one wing is lower than the other. This is an incipient spin. To right the ship, push the stick, way over toward the high wing, moving it at the same time forward. The ailerons will take effect as soon as some forward speed is acquired.

Conclusion.—It is important that a pilot know how to act in case of a stall. But when he has once experienced the moment when the controls are inefficient, and has pushed the stick forward to recover, he will be prepared for later emergencies.

Three Things to Remember about Stalls:

1. When the controls begin to feel "soft" (*i.e.*, when the ship's response to control movements is slow), push the stick forward.
2. Stalls always threaten to result in spins. Therefore, keep your nose down, and beware of the stall.
3. In order to avoid stalls—keep flying speed!

Cautions to Motored-plane Pilots:

1. Learn to recognize the moment when it is imperative to dive. The controls of a glider are comparatively "soft" most of the time.

CHAPTER XIII

LANDINGS

LANDING is the act of grounding the glider. A glider drops to the earth when it loses flying speed, *i.e.*, when it stalls. In order that the ship may not be damaged by landing, the stall should be brought about when the plane is flying close to the ground. You must acquire a good deal of skill before you will be able to execute landings with precision. A poor landing is apt to injure the glider; but the pilot himself is seldom severely hurt by the impact of the plane on the ground, since a glider is light, contains no combustible fuel, and has a low stalling speed.

Wind Direction.—Always aim to land directly into the wind. The glider pilot's object is to maintain air speed as long as possible, and, at the same time, to land with the lowest possible ground speed. As in a take-off, when you are flying straight into the wind, air speed is greater than ground speed by an amount equivalent to the velocity of the wind.

During your first few glides, you will not need to consider wind direction before landing; you will make no turns from your original course, and the wind will not have time to change measurably. As your flights become more extended, however, you must watch for wind-direction indicators as you near the ground.

It is well at this time to familiarize yourself with the various wind indicators. Regular airports have T's or wind socks, for the benefit of incoming planes. The T is a large wooden letter T, parallel to the ground, with the stem of the T pointing on the direction in which the wind blows. A wind

LANDINGS

sock is a tapered cloth tunnel, usually about 3 to 5 feet in length, through which the wind blows. One end of the tunnel is fastened to a pole and the sock blows out with the wind, somewhat like a flag (see Fig. 74). But since gliders are not apt to land near a flying field, you must learn to rely upon leaves and grass, smoke from stationary stacks, clothes on a line, ripples in water, etc., as wind indicators. Do not take

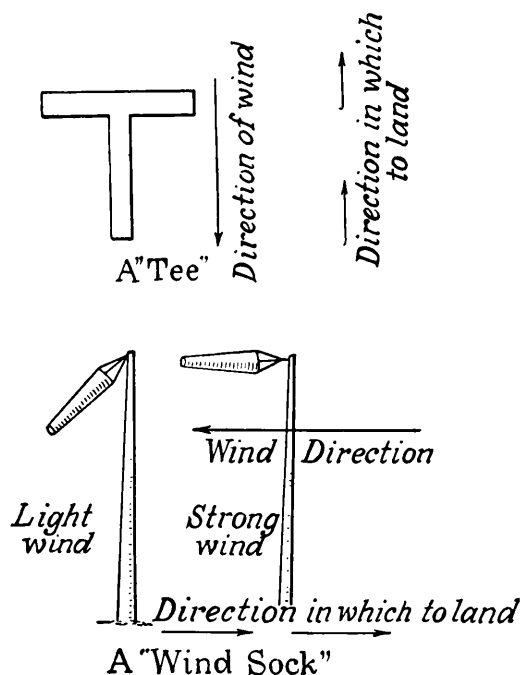

FIG. 74.—Wind indicators. The usual methods of showing wind direction on the flying field are by means of tees and wind socks. The tee can be seen farther but the sock gives an idea of the speed of the wind.

the feeling of the air against your face as an indicator of wind direction; it tells you nothing but your angle of yaw.

If you find, when you are already near the ground, that you are not flying straight into the wind, it is not usually best to attempt to change your course. A turn at very low altitude might be dangerous. Unless the wind is extraordinarily high, you can land in a cross wind. Cross-wind landings are described in a later paragraph. If you are landing in a tail wind, keep the stick well back. If the wind should get under the rear edges of the elevators or wings, there is a possibility of the ship's "nosing over." Of course,

you should normally not land with the wind, because this makes your landing speed unduly high.

Choosing the Place for the Landing.—As long as your glides are short and you gain little height, you will not have much choice of landing place, once you are in the air. That is why it is essential that you have a long open stretch ahead when you take off.

When you are able to look about for a landing place from a greater altitude, and when you have time to change your course before reaching the ground, you will have a wider choice. Then you must select the best and most level spot available.

Occasionally, gliders are forced to land in the water. In this event, the thing to do is to unbuckle one's belt and to swim in, towing one's craft. The plane will float until it is waterlogged. Such catastrophes happen, as a rule, close to the shore.

Steps in Making a Landing.—There are two methods of landing, one of which is to continue the normal angle of glide, until the ship comes gently to the ground without the aid of any control movements. This method is particularly fitted for use on the level ground or on gentle slopes.

But, if you are obliged to land on a steep incline or if your glider has wheels, there is some danger of "nosing over," if you land with the tail in the air. In this event, you must land in another way. This way is discussed at greater length here, not because it is more important, but because it is more difficult. The proper method to employ depends upon the type of ship used.

1. *Leveling Off.*—In order to land by this latter method, bring the stick back gradually to neutral just before reaching the ground, so that the ship's position changes from an angle of glide to the horizontal. (This method is comparable to the "three-point landing" of a motored plane.) If the

LANDING S

angle of glide has not been too sharp, the plane will level off easily with this slight backward movement of the stick.

2. *Stalling*.—When the glider is in a level position, hold the stick stationary. The ship will continue forward but losing speed, settling to the ground at the same time. When its speed has become so slight that it no longer sustains itself in the air it will stall of itself and settle. Settling can be hastened by gently easing the stick back. An experienced pilot may pull it way back with some firmness (see Fig. 75).

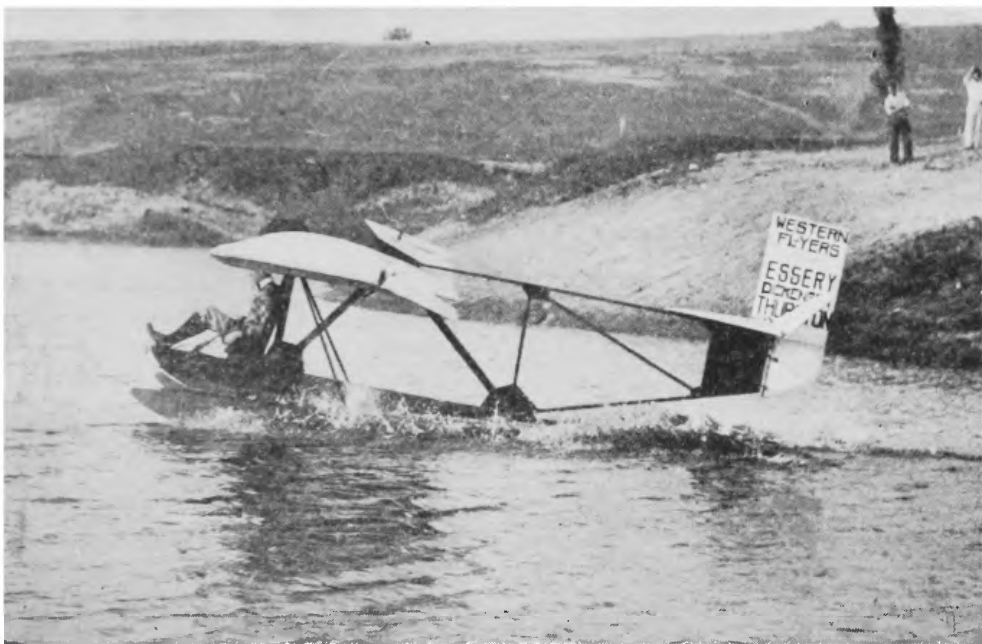

FIG. 75.—Stalling the ship. This is a combination land and water glider, in other words, an amphibian.

3. *Grounding the Glider*.—When the ship has stalled, it will drop directly to the ground. The aim of the motor-plane pilot in effecting a “three-point landing” is to have both wheels and tail skid touch the ground simultaneously. If the glider has been brought exactly to a stalled position, it too will make the equivalent of a “three-point landing.” As you reach the earth, do not put your feet on the ground to stop the glider; your feet might be caught under the fuselage and be crushed. It is important also to keep your

feet on the rudder bar so that you can keep the glider headed straight.

You must take care to maintain lateral balance throughout the landing. When the glider has come to a full stop, however, it usually cannot remain balanced on its single skid, and one wing will drop slowly to the ground. But in a 10- to 15-mile wind a good pilot is able to hold up this wing indefinitely.

Faulty Landings.—To make a perfect landing requires a great deal of practice. Although faulty landings do not usually have serious consequences, you must learn to avoid them. The worst mistake beginners make is to level off too soon, with the result that the stalled ship drops from too great a height. This is called a “pancake landing.” The consequent shock may rack the glider. Do not get ready to land prematurely. The ground will impress itself upon your consciousness as it, seemingly, rises to meet you. If you neglect to pull the stick back, when landing on a steep slope, the forward part of the fuselage will strike the ground first, and the ship will tend to rock forward onto the nose. If you pull the stick back too far, the glider will stall too soon. If you pull the stick back too soon and too far, while you still have considerable forward speed, the glider, instead of stalling, will start to climb again. Unless the stick is then immediately pushed way forward, the glider will then stall and drop, probably damaging itself.

Sometimes you may fly farther than you expected, and realize that you will not be able to complete your landing before overtaking an obstacle. In this case, push the stick well to one side, until the wing tip drags on the ground, and swings you around. Do not do this unless it is absolutely necessary, since it will probably damage the wing.

Spot Landings.—A “spot landing” is an attempt to land the glider at a point marked out on the ground. The practice of spot landings adds to the pilot’s skill. You

LANDINGS

may at some time be forced to land in a very small place. Spot landings are easier in gliders than in airplanes: a glider pilot is able to see the place marked for the landing until the instant he grounds the plane. Therefore, spot landings in gliders can be made with great accuracy.

Cross-wind Landings.—One danger of a cross-wind landing is that the wind will be carrying the ship crosswise while it is landing straight ahead. As the ship touches the ground, the wind may wipe off the landing gear. In order to land the plane in a cross-wind, then, the best plan is usually to sideslip into the wind. For example, if the wind is coming from the right, bank the plane a little, so that the right wing is lower than the left, without any corresponding rudder movement. This will prevent the wind from catching under the right wing tip. Dive the ship a little at the same time to prevent stalling. Just before you reach the ground, right the ship. This method of cross-wind landing should remove the danger that the landing gear be side-swiped in landing.

Returning the Glider to the Taking-off Place.—Gliding is something like coasting: you have to spend most of your time toiling uphill. If the glider has to be carried a short distance only, it can be lifted by a man at each wing tip, and one at the nose and the tail (see Fig. 76). A more convenient method is to have a pair of wheels, on which to set the fuselage. The glider may then be drawn up the hill by men, a horse, or an automobile (see Fig. 77).

Soarers frequently make long flights and have to be carried long distances. For this reason they are usually built so that they may easily be taken apart and fitted into a truck or trailer.

Four Things to Remember about Landings:

1. Whenever possible, land into the wind.

GLIDING AND SOARING



FIG. 76.—One method of carrying a glider uphill. This means is practicable only for a short distance.



FIG. 77.—This means of transporting a glider requires less exertion. Here the weight of the ship is borne by the wheels upon which the fuselage is set.

LANDINGS

2. Hold the stick forward if the terrain permits. Otherwise, do not pull the stick back too far or too soon. Watch your terrain and learn the requirements of your individual ship.

3. Maintain lateral balance throughout the landing.

4. When you have brought the ship to the ground, do not get cut and leave it. The wind works mischief with empty gliders.

5. Until you are within a foot of the ground, keep flying speed.

Cautions to Power-plane Pilots:

1. If you fear that the landing will be a poor one, make the best of the situation. You cannot "give her the gun and go around again."

2. Do not level off at too great a height. The glider loses less altitude between the levelling off and the stall than does the airplane.

3. Do not worry if you must land in front of an obstacle. A glider does not roll ahead after it is gounded.

CHAPTER XIV

TURNS

ATURN is a deflection to the left or right from the directional course of the glider. As soon as you are able to make straight glides of nearly 30 seconds' duration, you should begin to practice turns. A turn is one of the most difficult of the elementary maneuvers, since it requires perfectly coordinated movement of all the controls.



FIG. 78.—A bank. This glider is making a gentle left turn. By use of left rudder and movement of the stick to the left, the ship has been tilted into this bank. Note the angle of glide which insures the pilot against the danger of stalling.

Bank.—In a turn, the nose of the glider is swung sideways by a movement of the rudder. Use of the rudder is not, however, sufficient to effect a correct turn: just as the bicycle rider leans inward when going around a corner, so

TURNS

the glider must be “banked.” To bank the glider means to lower the wing which is nearer the center of the arc of the turn. For example in a left turn, the ship is banked to the left; *i.e.*, the stick is pushed to the left, lowering the left wing. Bank is necessary to offset centrifugal force, which

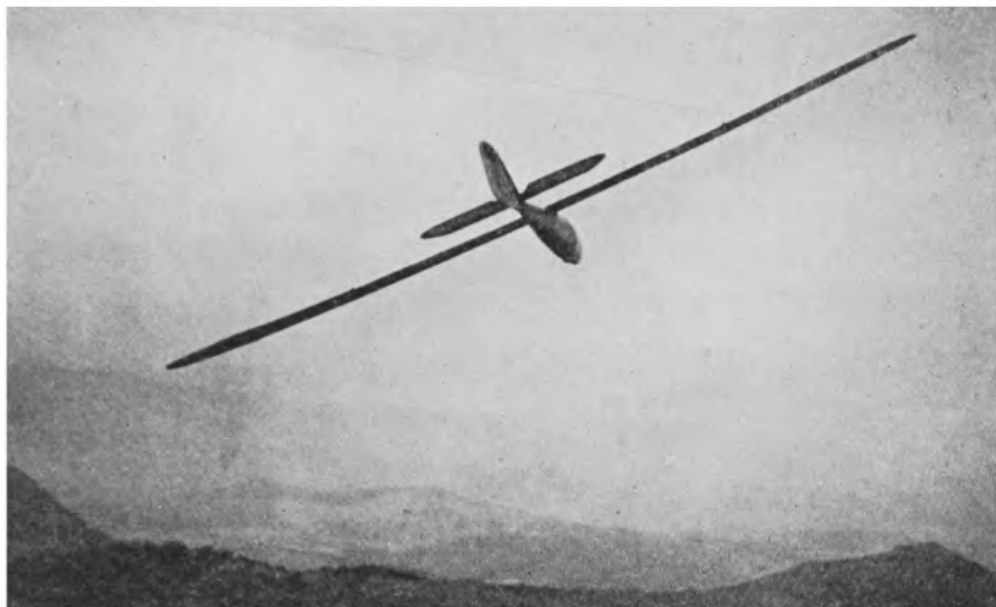

FIG. 79.—A soarer making a sharp left turn. Since a steep bank adds greatly to the ship's drag, it is usually unwise to make turns much tighter than this one.

would otherwise cause the plane to skid. Figures 78 and 79 show banked ships.

Steps in Making a Turn.—In order to render the process of making a turn easier to comprehend and to remember, it is divided here into five distinct sets of control movements. In actual flight, these movements are so closely connected that no separate steps are discernible: the controls are in gradual, continuous movement. These five steps are shown in Fig. 80.

First Step: Stick Forward.—During a turn, the glider's drag is increased and its lift decreased; the sharper the turn, the greater the loss of speed. Therefore, before the

turn is begun, it is necessary to dive the ship a little. Push the stick slightly forward and keep it there. Do not neglect the elevators when you are half through the turn, allowing them to rise. Speed is essential to flight, and flying speed may be lost if the stick is not held forward. Do not start a turn, unless you have sufficient altitude to be able to dive slightly.

Second Step: Going into the Turn.—In order to start the plane turning, both rudder and bank are necessary. To make a right turn, push your right foot forward on the rudder bar, and move the stick to the right. For a left turn, the reverse of these control movements should be used.

Third Step: In the Turn.—More rudder and bank are required to start the turn than are necessary to keep the glider turning. When the ship is banked, the higher wing describes a wider arc than the lower wing (see Fig. 81). It travels at a greater speed, and consequently has more lift. Therefore, the plane, once banked, tends to bank itself more. Steep banks, resulting in sharp turns, are however, dangerous: they must never be attempted except in soaring flight, and when the speed of the plane is high.

Pressure on the rudder bar and stick should, therefore, be relaxed as soon as a bank of 15 to 20 degrees is reached. In order to counteract the ship's tendency to bank farther, considerable movement of the stick toward the upper wing may be necessary. The amount which the rudder should be moved can be learned only by experience.

Fourth Step: Coming Out of the Turn.—To leave the turn, apply opposite rudder and aileron; *i.e.*, to come out of a right turn, move the stick to the left, and push your left foot forward on the rudder bar. The plane will gradually return to its normal position.

Fifth Step: Neutralizing the Controls.—As soon as the turn is completed, put the stick and rudder bar back into neutral.

TURNS

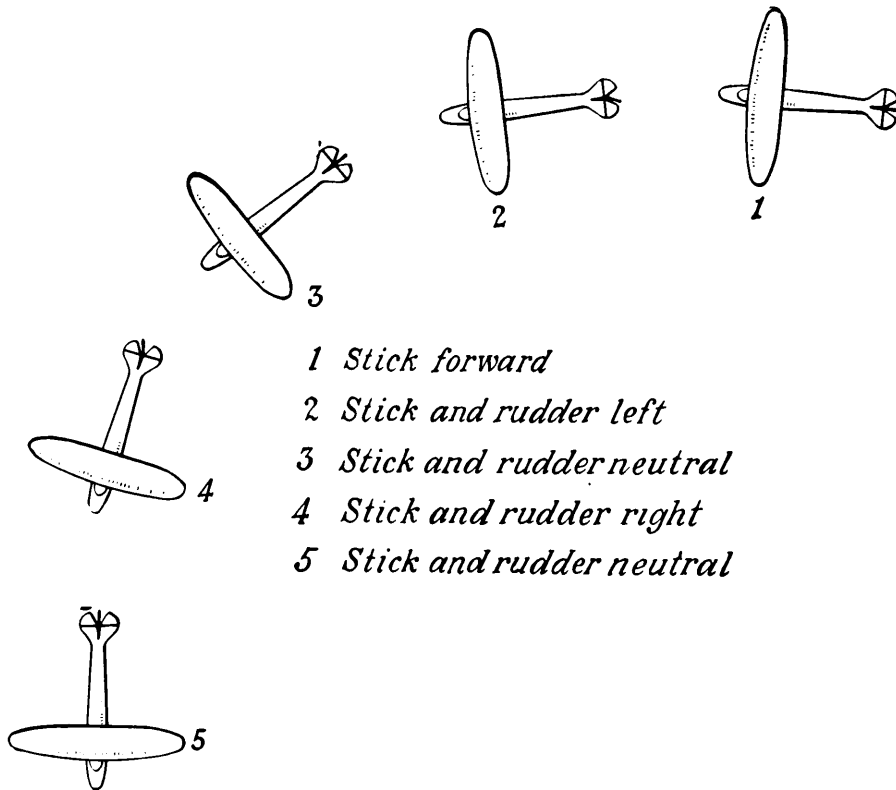

FIG. 80.—Steps in making a left turn.

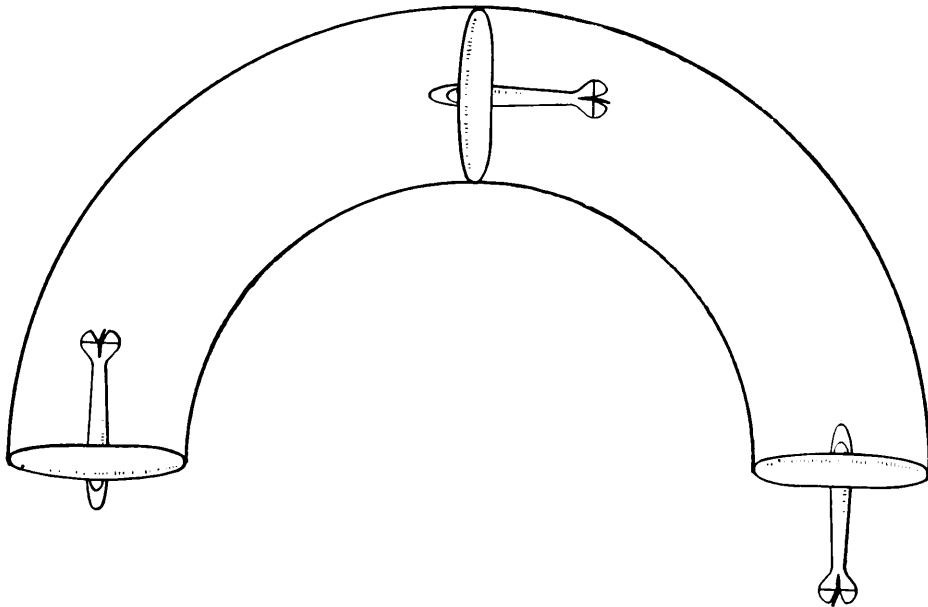

FIG. 81.—A glider once banked tends to bank itself further. The arc traversed by the outer wing is greatest; therefore the outer wing travels faster and has more lift.

GLIDING AND SOARING

If you continue to hold them in the position where they were at the end of Step 4, the glider will start to turn in the opposite direction.

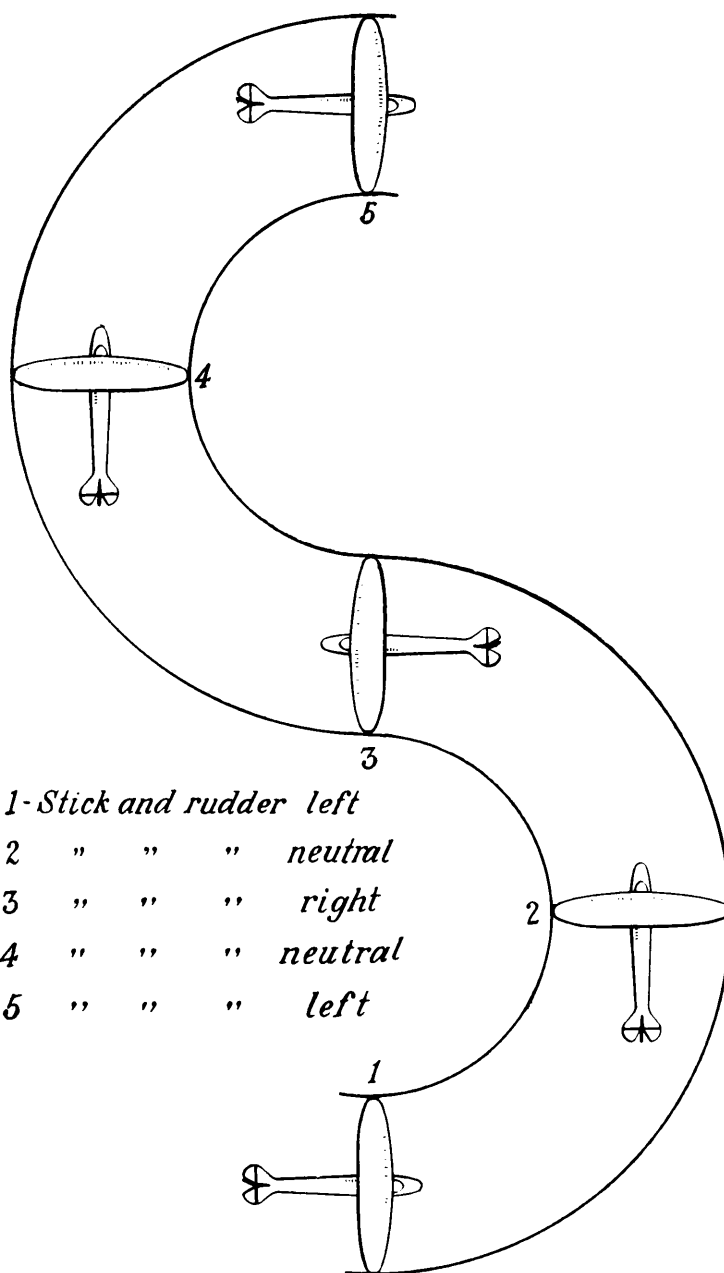

FIG. 82.—An S turn.

S-turns.—If the controls are not returned to neutral at the end of the turn, and the glider does start to turn in the opposite direction, the result will be an S-turn. An S-turn is a turn in one direction followed by a turn in the other.

TURNS

The change from one turn into the next must be a gradual and continuous one, otherwise the maneuver will be jerky.



FIG. 83.—A glider in tow making a left turn.

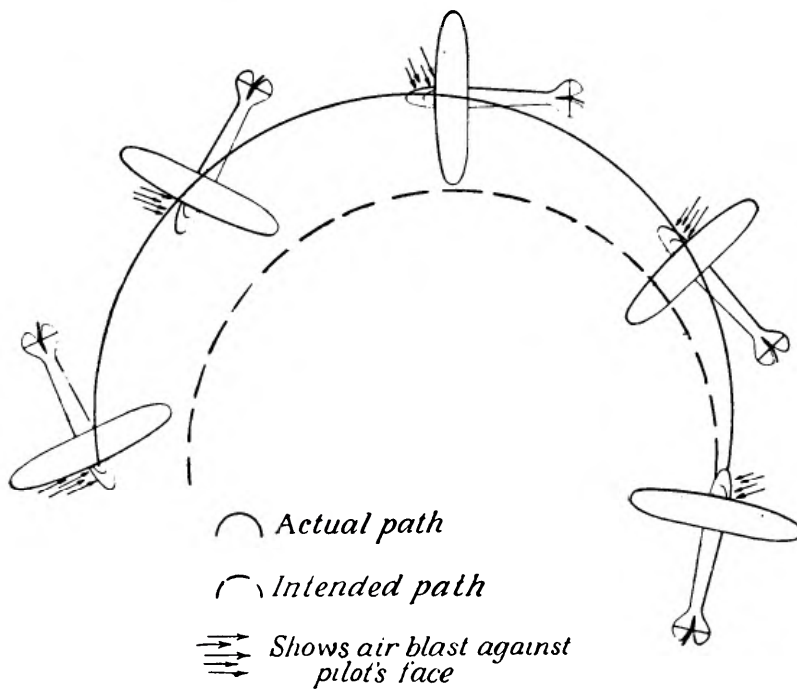

FIG. 84.—A skid.

S-turns can be made only after you are capable of comparatively long glides. They are an excellent means of practicing turns (see Fig. 82). Any number of successive S-turns can

GLIDING AND SOARING

be made in a glider which is towed behind an automobile at a low altitude (see Fig. 83).

Skidding and Slipping.—If rudder and bank are not used proportionately during a turn, a skid or a slip will be the result. A skid is a slide of the glider outside of its path of flight (see Fig. 84). It is caused by an undue pressure on the rudder bar, coupled with insufficient bank. A skid is evidenced by a feeling of wind on the side of your face near the raised wing. (You must learn to notice the currents of

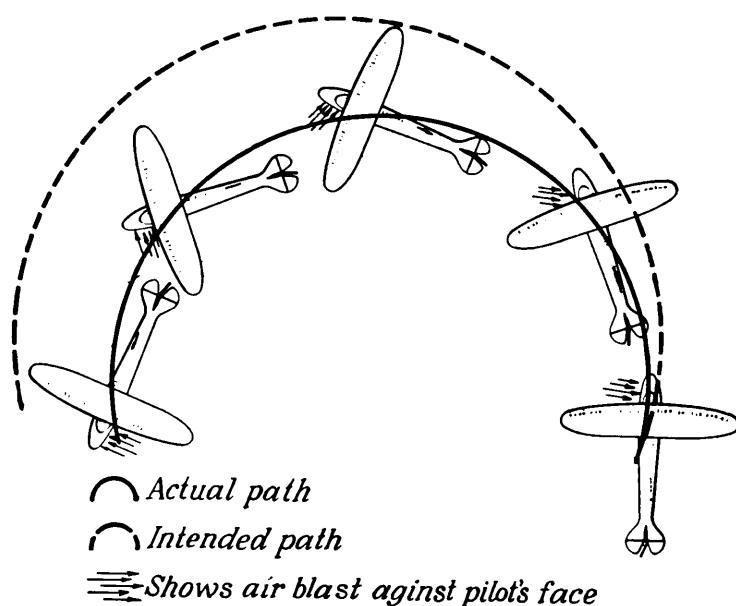

FIG. 85.—A slip.

air which strike your face: they are highly significant.) To counteract a skid, relax some of the pressure on the rudder bar, probably even with some pressure temporarily in the opposite direction.

A slip is a slide of the glider inside its path of flight (see Fig. 85). It is due to too sharp a bank and corresponding insufficient pressure on the rudder bar, and should be corrected, either by a decrease in bank, or by an increased amount of rudder. Air pressure on the side of your face near the depressed wing will make you aware that you are slipping.

TURNS

Skids and slips are dangerous because they cause loss of speed. It is, however, practically impossible for a beginner to use rudder and bank in exact proportion at first. Therefore, if you feel that you are losing control, the safest plan is to come out of the turn by applying up rudder and aileron, and to dive to regain speed.

Conclusion.—Turns are the very essence of gliding. Practice them until they become second nature to you. If you find that you are able to turn in one direction more easily than in the other, practice the more difficult turn, until you can make them both equally well. You cannot even fly straight without knowing the principles of turns: for the glider continually tends to deviate from its correct course, and you must be able to turn in order to counteract this tendency.

Four Things to Remember about Turns:

1. Push the stick forward before beginning to turn.
2. Use rudder and bank simultaneously and in proportion.
3. When you feel a strong air current coming in on one cheek, push the stick to the other side.
4. Keep flying speed!

Cautions to Power-plane Pilots:

You are accustomed to allow for the torque on an airplane, whenever you make a turn. The glider, of course, has no torque, so that no additional pressure on the rudder bar and stick is necessary in making a right turn.

CHAPTER XV

WATER GLIDERS

A WATER glider is a glider which takes off from and lands on the water. Water gliders are of two general types: gliding boats, *i.e.*, gliders with a fuselage which rests directly in the water; and float water gliders, which rest on the water on a float attached below the fuselage. Water gliders may also be classified as monoplanes and biplanes. Since water gliders are necessarily heavier than land gliders, none have yet been built which have a high enough performance to soar. In fact, the experiments made with water gliders of any sort are comparatively few as yet.

What Does a Water Glider Look Like?—In general, the water glider differs from the land glider in only one significant respect: the undercarriage. The skid or wheels are replaced in a water glider by a float and wing-tip pontoons, or by a water-tight fuselage.

A float water glider commonly rests on one boat-shaped float. This is usually built of plywood, covered with "doped" cloth, or sometimes with duralumin. Two pontoons, running parallel to one another, such as those used on many motored seaplanes, have been reported to be less satisfactory than a single float. The fuselage of a gliding boat is streamlined, and covered with fabric treated with dope, or built of metal. Most water gliders are equipped with a small pontoon fastened under each wing tip. These pontoons prevent the wing's striking the water in case lateral balance is lost while the glider is afloat or when landing. The float or fuselage of a water glider is ordinarily

WATER GLIDERS

stepped like a hydroplane. A float water glider and a gliding boat are shown in Figs. 86 and 87.

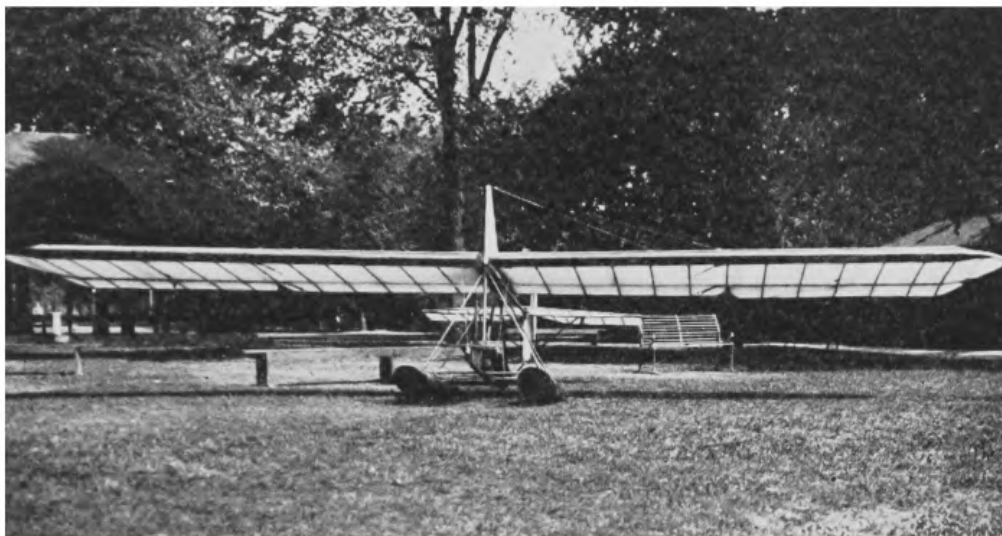

FIG. 86.—A pontoon water glider. This is a primary training glider equipped with pontoons.

The appearance of a water glider sometimes differs from that of a land glider in other respects. In the first place,

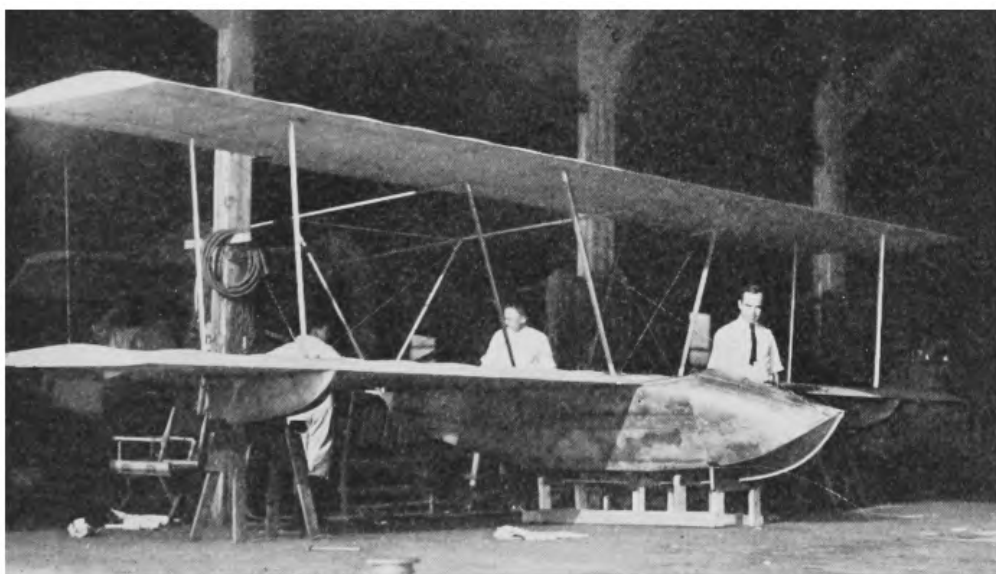

FIG. 81.—A gliding boat. The fuselage of this glider is built like a boat and rests directly on the water. The small pontoons under the wing tips help to preserve lateral balance while the glider is afloat.

the fuselage of a water glider is nearly always closed, in order to give greater efficiency, and to protect the pilot

GLIDING AND SOARING

from the spray. Gliding boats must, of course, always have closed fuselages. In the second place, water gliders are more usually biplanes, whereas most land gliders are monoplanes.

Experiments have been made with many kinds of winged boats, some of which cannot strictly be called gliders as they are not designed to rise from the water but use their wings for lifting power. Others are designed always to be towed and lift only a few feet. The controls of such semi-gliders as these differ in some instances from those of a land glider. Gliding boats have been built, for instance, which are equipped with outboard motors; one of these has a fixed rudder, another has no vertical fin whatever.

Take-offs.—A water glider is usually launched into the air by being towed behind a speed boat. The procedure here is much the same as when a land glider is towed behind a motorcycle or an automobile. It is preferable that the towline be of wire; since, when a rope is used, its friction dragging through the water is too great a handicap for the motor boat.

A suitable position for the take-off must be chosen in the water, as on land. A water glider should be launched directly into the wind. This rule may easily be adhered to, since the water glider is not dependent upon the contour of the land, and may be towed in any direction. (In rivers, of course, this does not apply.) When the ship is allowed to float on the surface of the water, it will tend to turn, of its own accord, until, like a weather vane, it is headed into the wind. The intended path of flight should extend over a long stretch of water unobstructed by boats, buoys, etc. The path should be even longer than that planned for a land glider, since the water glider may have to be towed several hundred feet before it takes off. Even slight obstacles may injure the float; if one is encountered while the glider is in tow, the pilot must try to cut loose from the towing craft, and turn to avoid the obstacle. Turns are effected by use of the rudder and ailerons as in flight.

WATER GLIDERS



FIG. 88.—Glenn Curtiss's water glider. Note at the left the wake of the motor boat which is towing the glider. The glider at the right is flying free.

GLIDING AND SOARING

As soon as the glider begins to gain speed in the water, the pilot should pull the stick back to aid the take-off, and to prevent the nose from dipping under the water. If the float or hull has a step, the bow will rise from the water while the ship is still afloat, so that there is a pocket of air between the float and the water. This is called being "on the step." The effect produced by the step reduces the resistance of the water against the float, and offsets the suction which tends to hold the ship in the water.

When the glider leaves the water, the stick must be held somewhat forward, so that altitude will not be gained too quickly.

Before taking off in a water glider for the first time, it is a good idea to be towed about for a while at slightly less than flying speed. This allows the pilot to accustom himself to the use of the controls.

Flight.—Once the glider is in the air, the land-glider pilot will have no difficulty in maneuvering it. Either he may cut loose from the speed boat and glide down (see Fig. 88), or his ship may be towed like a kite at the end of a several-hundred-foot rope fed from a reel on the motor boat.

Landing.—The landing of a water glider is effected in practically the same way as that of a land glider, except that the former will coast ahead a little way over the surface of the water before it comes to a full stop. The ship must be stalled so that the heel of the float reaches the water first, and drags until the entire float is level in the water, in other words a "nose up" landing (Fig. 89).

Sailing.—After the last landing, the glider must be beached. If the wind is in the wrong direction, the ship has to be towed ashore; but, if the wind is right, water gliders can be "sailed," by use of the rudder and ailerons. In sailing, a depressed aileron acts like a sail, while a raised

WATER GLIDERS

aileron has practically no effect. The rudder serves to steer. A water glider can be made to tack to the right, for example, while facing into a head wind, by lowering the right aileron.

The Waterplane.—The planes already referred to which have either a fixed rudder or none at all are equipped with outboard motors (see Figs. 90 and 91). The outboard motor



FIG. 89.—Water glider.

rests on a pontoon, and the pontoon is hinged to the flying boat by shafts or arms. As soon as the contrivance gains speed, the boat and its pilot take off, leaving the pontoon with the motor in the water to push it ahead. Speeds of 40 or 50 miles an hour can be gained this way. Water planing is an exciting sport, and has some training value in the manipulation of controls. Another form of planing boat is one with a narrow, inclosed hull equipped with an outboard and glider wings. In still a third one, an ordinary Sea Sled Boat has glider wings mounted on it and uses an outboard motor for power. In neither of these latter types does the

GLIDING AND SOARING



FIG. 90.—A waterplane in flight. This craft, propelled by an outboard motor, is a combination glider and speed boat. The wings lift the body of the ship high enough into the air to give the pilot some of the sensations of flight.



FIG. 91.—Another waterplane. The rudder of this ship is stable. But the ailerons and elevators provide the pilot with some opportunity of practicing the use of airplane controls.

WATER GLIDERS

boat leave the water, because of using a water prop, but considerable speed is obtained owing to the lifting power of the wings, and this affords excellent practice in learning wing control as well as providing good sport.

Amphibians.—An amphibian is a combination water and land glider. The first successful amphibian was flown by



FIG. 92.—An amphibian. This amphibian is about to land on a lake after having flown about a half mile. It took off from a hill and was flown by William Van Dusen.

William Van Dusen, built to take off from a hill or mountain and to land in a lake or on the ocean. This amphibian is shown in Fig. 92. It has rugged pontoons, which serve on land as skids. Although pontoons necessarily add to the parasite resistance, this type of glider has obvious advan-

GLIDING AND SOARING

tages: it will greatly increase the amount of soaring terrain available, and it will add to the safety of the sport.

Conclusion.—Water gliders have not yet been widely used, owing to their lower performance and relatively high cost of construction. Glenn H. Curtiss, a pioneer of American gliding, said of the water glider which he built a few years ago, “It was an interesting plaything and taught something in the way of light construction; otherwise, I do not consider it much of an achievement.” This machine, however, did more than Mr. Curtiss realized, by pointing the way which others were later to follow.

PART FOUR

SOARING

CHAPTER XVI. Wind Currents and Their Behavior

CHAPTER XVII. How Birds Fly and Soar

CHAPTER XVIII. Static Soaring

CHAPTER XIX. Dynamic Soaring and Acrobatics

CHAPTER XX. Duration and Long-distance Flights

Part Four describes those advanced flight maneuvers which depend upon the utilization of special currents of wind. The science of soaring is still very incomplete, and a mastery of the principles set forth in this section of the book should encourage the reader to further experimentation on his own initiative.

Chapter XVI describes what is at present known of the different kinds of wind currents of which the soarer pilot must avail himself, where they occur, and what different forms they take. Chapter XVII tells how birds make use of wind currents, and points the way whereby the reader may make further discoveries by observing soaring birds. Chapter XVIII tells how soarers remain in the air by making use of upward currents. Chapter XIX suggests how use may be made of variations in horizontal wind currents; it also includes a discussion of several of the more complicated maneuvers. Chapter XX tells under what conditions and by what means long-distance and duration motorless flights may be taken.

CHAPTER XVI

WIND CURRENTS AND THEIR BEHAVIOR

BEFORE you begin to soar, you must learn something about wind currents: what currents can be utilized in flight, where they are found, and how they may be recognized. Wind currents have only recently been studied in detail, hence knowledge about them is still slight. Every soarer pilot should consider it his duty to read all available material on the subject, and to add to the science whatever discoveries he can make in his own flight.

Upward Currents of Air.—Wind currents may be placed in several different categories, according to the direction of the compass, velocity, duration, and the plane in which the currents are blowing (*i.e.*, whether they are vertical or horizontal). The distinction between vertical and horizontal currents is important to the soarer pilot. He avails himself of the former according to the principles of static soaring, of the latter in accordance with the principles of dynamic soaring. Vertical, or upward, currents of air provide the less difficult means of soaring.

Where Upward Currents Occur.—Soaring is usually done on the windward side of hills or even mountains, because upward currents are prevalent there. When the wind blows across a plain, it moves nearly horizontally; when it strikes the side of a mountain, however, it is deflected upward.

Although mountain regions are most used by soarers, rising air may also be found on the windward sides of low hills, and at the edges of bodies of water. There are three general causes of vertical currents of air.

GLIDING AND SOARING

Upward Currents Due to Irregularities in the Terrain.—The irregularities of the earth's surface force the lower strata of the wind into undulating courses. Even low hills, houses, and forests divert the wind slightly upward.

The wind does not follow exactly the contour of an irregularity of terrain. This is illustrated by the dune formation on top of a low, steep bank on the sea coast. The wind, coming from the water and carrying sand with it,

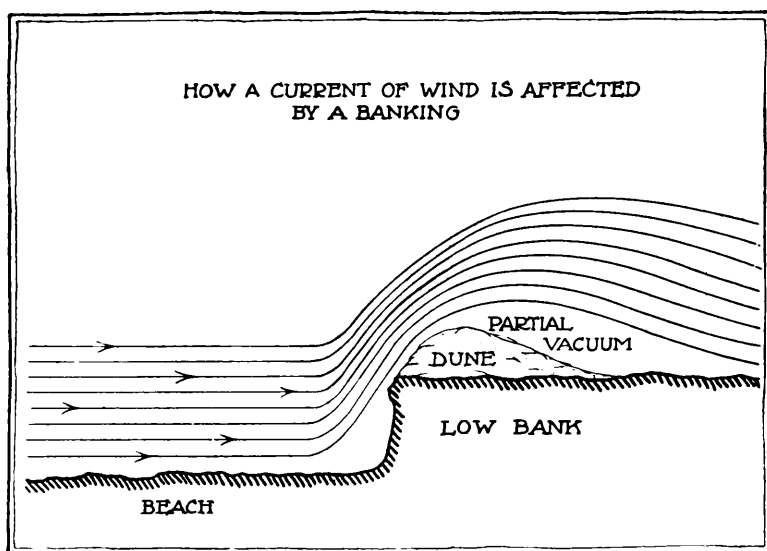

FIG. 93.

strikes the bank and goes upward, its flow lines, so far, parallel to the contour of the bank. Then, however, instead of clinging to the plateau at the top of the bank, the wind continues upward, leaving a partial vacuum between itself and the embankment, into which the sand falls, forming the dune. The flow lines of the wind gradually sink behind the dune, and resume their horizontal course, as Fig. 93 shows. The upper strata of the wind are affected less and less by irregularities of terrain as their altitude increases.

Pictures of the way in which streamlines follow the contours of several mountains have been made by photographing the path taken by clouds of ammonia smoke from rockets.

WIND CURRENTS AND THEIR BEHAVIOR

Thermal Currents.—Convection is another cause of upward currents of air. Portions of the atmosphere over certain kinds of terrain are heated by the sun to a higher temperature than are other parts. The warm air is lighter

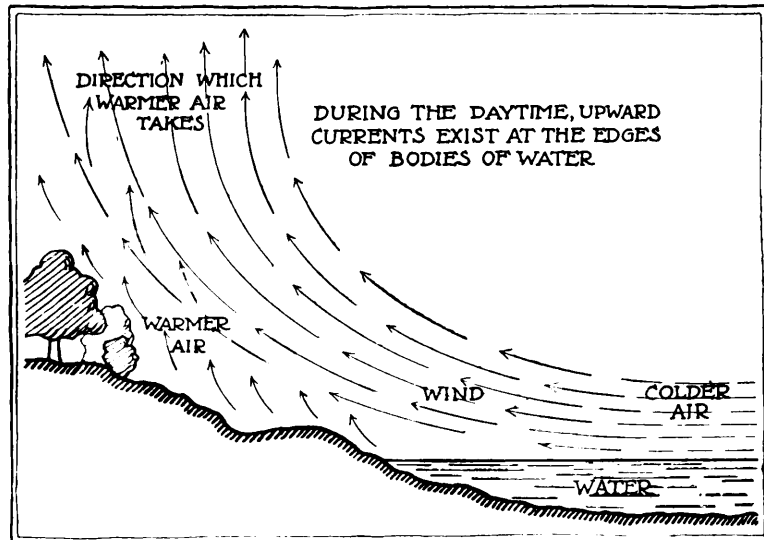

FIG. 94.

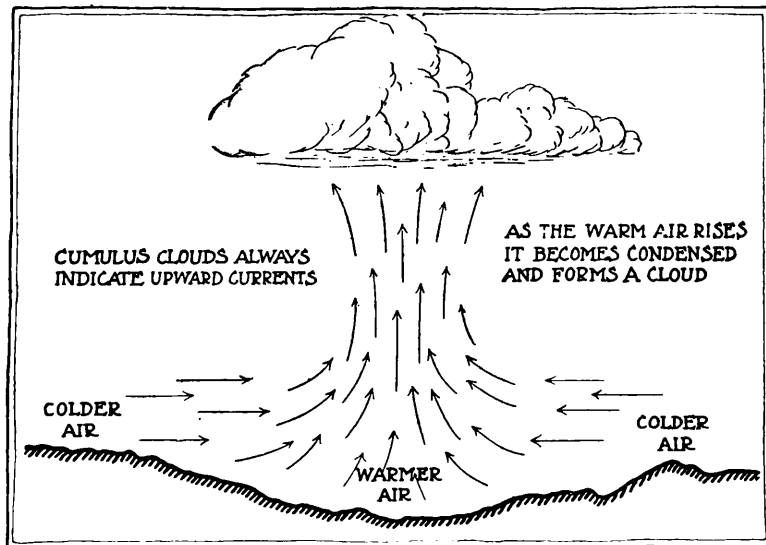

FIG. 95.

and therefore rises in upward currents. The colder portions of air, since they are denser, rush to displace those which have risen. This process is called “convection.”

For example, the earth changes its temperature more rapidly than does water. Consequently, during the day, the

GLIDING AND SOARING

air over a body of water is not so warm as the air above the shore. As a result, there is a constant rising current of warm air along the water's edge (see Fig. 94).

As warm air rises, it cools off gradually, and finally condenses to form cumulus clouds. Wherever there is a cumulus cloud, the pilot may be sure to find an upward current (see Fig. 95).

Soarer pilots can determine where thermal currents exist by studying the nature of the earth's surface over which they intend to soar, and by learning the relative

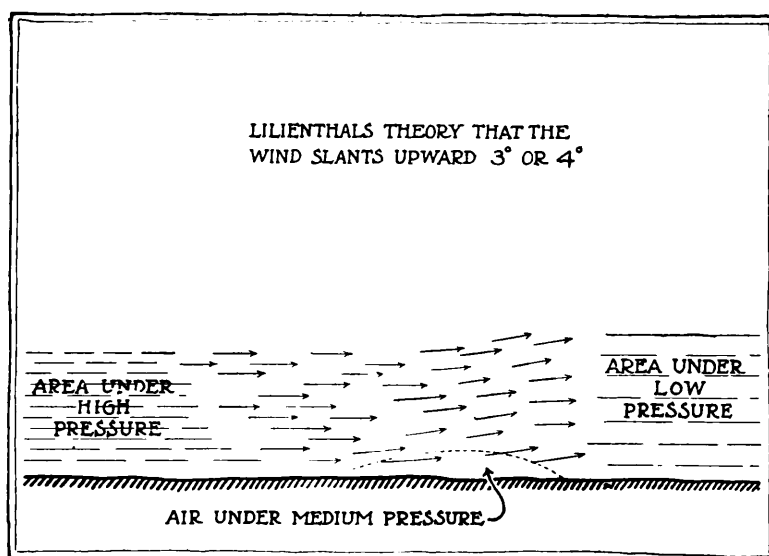

FIG. 96.

rapidity with which forests, sand, fields, etc., are heated by the sun. These currents are, of course, found only during that part of the day in which the sun is warm.

Lilienthal's Theory of the Wind.—Lilienthal evolved a theory (the third cause of upward currents) that the wind does not blow horizontally, even over level surfaces, but rises at an angle of 3 or 4 degrees. He explained this theory by saying that air in a high-pressure region, moving toward a region of low pressure, encounters motionless air in a place of medium pressure. The cold air from the field of high atmospheric pressure tends to push ahead the air in

WIND CURRENTS AND THEIR BEHAVIOR

the medium field; the latter tends to resist this pushing, becomes dense, and escapes upward. This escape causes the wind to diverge from its horizontal course, as Fig. 96 shows.

Theoretically, if Lilienthal's conclusions are correct, a soarer with a gliding angle of 3 or 4 degrees could maintain level flight as long as the wind blew. But this feat has never been accomplished.

How Upward Currents Are Offset.—As long as the sun shines, thermal currents appear daily in the same places, other conditions remaining unchanged. Rising currents are not always caused, however, by irregularities in the earth's surface. Other irregularities may prevent upward currents from being caused by the particular irregularity in question. For instance, if the wind blew for several days across a plain toward one side of a mountain, the pilot would doubtless find constant upward currents to the windward of its peak. If, however, the wind should then change, so that it blew toward the mountain from across a forest and several low hills, the pilot would find only a weak upward current.

Some terrain formations cause so many eddies and whirlpools of air that they are dangerous to the uninitiated. Such zones usually exist where chains of hills are ranged in horse-shoe shapes so that they catch the wind.

Usefulness of the Various Kinds of Upward Currents.—Upward currents, like all wind currents, may be classified according to duration, velocity, and the compass direction of the wind which resolves itself into them. It is obvious that the longer the upward current endures, the more useful it is to the soarer. A rising current's effectiveness is supposed to depend largely on its velocity, on the assumption that the greater the velocity the higher the altitude to which it rises. The importance of the wind's compass direction varies with the region in question. The angle of the current to the horizontal must be considerable in order to prove most effective.

GLIDING AND SOARING

Horizontal Wind Currents.—Horizontal currents are useful to the soarer pilot because of their variations. The atmosphere may be considered to consist of layers of air, one above another. These layers move at relatively different speeds. The friction caused by the earth's surface retards the lower strata. With increasing altitude the strata move with greater velocity (see Table II). For example, an atmospheric stratum at a height of 100 or 200 feet often moves with twice the speed of the layer next the ground. Every stratum is not necessarily more rapid than the one below it, however, for occasionally a stratum travels much more slowly than the main movement of the air.

Moreover, each individual stratum of air is affected by variations. These variations are caused by the friction between each two layers of air traveling at different speeds. The friction results in whirlpools of air. The condition of the atmosphere in which the presence of these whirlpools is pronounced is called "gustiness."

Other variations affect the individual stratum of air beside changes in velocity. Near the earth, local winds may blow in directions contrary to the main movement of the atmosphere. Moreover, horizontal gustiness may sometimes be found combined with rising currents.

TABLE II

THE WIND VELOCITIES¹ AT CERTAIN HEIGHTS AS MEASURED AT THE RADIO TRANSMISSION TOWER AT NAUEN (GERMANY)²

Time	Height above ground				
	2 m.	16 m.	32 m.	123 m.	258 m.
6 to 7 A.M.	3.1	4.3	5.0	7.2	8.7
12 to 1 P.M.	4.3	5.3	6.0	6.4	7.3
6 to 7 P.M.	3.1	4.7	5.4	7.2	7.4
12 to 1 A.M.	2.8	4.2	5.2	7.4	9.6

¹ In meters per second.

² J. P. Schroeter.

Soarer pilots have as yet been unable to make full use of frontal gusts of wind. Perhaps this is because of the

WIND CURRENTS AND THEIR BEHAVIOR

difficulty of developing means for detecting useful variations of the wind soon enough, and because soarers cannot yet be maneuvered fast enough for pilots to avail themselves of the full force of frontal gusts.

Conclusion.—The conditions of the atmosphere, the degrees to which various forces affect it, etc., are still very much unknown. The Weather Bureau and other government agencies have done most important work in charting large movements and in daily accounting of these. But as to the minute variations in which the soarer pilot is interested, almost unlimited work still remains to be done. It is the duty of aeronauts of the future to carry the early explorations further.

The way in which wind currents may be utilized by soarers will be discussed in the next two chapters.

CHAPTER XVII

HOW BIRDS FLY AND SOAR

FOR thousands of centuries birds have been exploring the atmosphere, and have acquired an acquaintance with it which would be invaluable to the human pilot. Lilienthal and the Wright brothers, when they first began to experiment with heavier-than-air craft, designed their gliders upon principles which they learned from bird flight. Figure 97 shows such a bird-like glider. But when the airplane was invented, with an application of power entirely different from that of birds, the analogy between birds and airplanes was considered less significant. Now that the glider pilot seems destined to be the greatest scientist in the laboratory of the air, however, he may learn much about the construction of wings, and about aerodynamics, meteorology, and flight from the behavior of the birds.

The Motive Power of Birds.—The flapping of a bird's wings may to some extent be likened to the revolutions of an airplane's propeller: it supplies the body of the bird or plane with power with which to maintain forward progress and thus to counteract the pull of gravity. The strokes of a bird's wings have two functions: first, they support him in the air, and second, they give him forward movement.

In order to support himself in flight, the bird makes a series of up-and-down strokes with his wings. At the beginning of each stroke, his wings are high above his body. Next, the wings are brought down forcibly through the air, somewhat like an oar in the water. This quick downward movement compresses the bird's feathers, mak-

HOW BIRDS FLY AND SOAR

ing the wings impervious to the air. When the wings are raised again, preparatory to another downward stroke, and the movement is more leisurely, the difference between the effective pressure of the quickly descending airtight wing and that of the same when ascending more slowly and partly pervious to the air represents the power which overcomes gravity and supports the bird in the air.

In order to propel himself, the bird holds the leading edges of his wings at a lower level than the trailing edges



FIG. 97.—Lilienthal glider 1894, as exhibited in U. S. National Museum.

on the down stroke. This has an effect upon air similar to that of oars upon water. The bird tilts his wings at this angle with the aid of the resistance of the air, which impedes the movement of their trailing edges, and at the same time tends to push their tips slightly forward. The angle of the wing is changed preparatory to the upstroke, so that the front edges are at a higher level than the back edges. Consequently, the force of the air helps to raise the wings.

Stability.—A bird's controls are more complicated, and at the same time more effective, than those of a glider. Lateral balance is easily maintained, since each wing moves independently of the other, and since the whole wing (not

just the ailerons, as on an airplane) is mobile: a hard stroke of one wing, or a change in its angle of attack, serves to bank the bird's body.

The bird controls longitudinal stability chiefly by means of his tail. This he employs as an elevator, raising or depressing it in order to climb or dive. He may give added effectiveness to the tail by spreading the feathers, or by cupping it to prevent the escape of air. Web-footed birds often use their feet to supplement their tails in maintaining longitudinal control. The bird may affect his upward or downward motion by raising or lowering his head. He is also able to increase or decrease the angle of incidence of his wings by rotating the bones which fasten the wings to his body.

The bird has several methods of controlling directional movement. He bends his body in the direction in which he wishes to take; or he banks by means of unequal wing strokes; or he employs his tail as a rudder, twisting its feathers.

A bird's wings are so built as to make various automatic movements to retain his balance. His wing is cup-shaped, near the body, to increase his lift. If the bird were in a climbing position, it might be expected that any sudden force of wind against the underside of the wing's trailing edge might send him into a dive. But the feathers are so elastic that they yield to the pressure of the wind, and thus prevent an involuntary dive. Similarly, a strong gust of wind impinging on only one of the wings flexes it and does not unduly increase its lift. This prevents loss of balance.

Bird's Method of Landing.—Birds, like gliders, are able to land without much jar, since they are comparatively light. But birds sometimes land in a peculiar way: by slanting their wings upward and approaching the ground in an almost vertical line. This simply means that the bird is stalled, and is consequently losing altitude; but the span

HOW BIRDS FLY AND SOAR

of his wing is great enough in proportion to his weight so that his descent is not too rapid.

Birds as Gliders.—Birds doubtless began their flight, in the process of evolution, by gliding from one tree to another, much as flying squirrels do. They use gliding now, as the airplane does, as a method of losing altitude. Birds are so light that even in a low wind they can glide for long distances without great loss of altitude.

Birds as Soarers.—Birds are extraordinarily proficient at detecting upward air currents. Although the smaller birds seem unable to soar, albatrosses, eagles, storks, buzzards, ravens, gulls, and others may be commonly seen making figure 8's over rising currents. A bird, while proceeding in a circular path, does not maintain a constant angle of bank. When he is facing into the wind, or against it, he adjusts his bank so that the wind will neither ruffle his feathers nor drive him outside of the stream of air in which he is soaring. Frequently, birds soar almost sideways, wings into the wind.

Birds can also travel long distances by means of occasional upward currents. Sea gulls, when they follow in the wakes of ocean liners, have various methods of relieving the tedium of long flights. If the wind strikes the vessel broadsides, resulting in a rising current, the gull soars into the wind to gain height, then turns and glides in the direction in which the steamer is going, until he loses his momentum. He repeats this process countless times. If the ship heads into the wind, the wind, continuously rushing downward to fill the partial vacuum left at the ship's stern, rebounds, causing an upward current in the ship's wake. Gulls have been known to soar for miles behind a steamer in such a wind, holding their wings motionless, being supported by the rising stream of air, and gaining forward motion by inclining the leading edges of their wings slightly downward. Shearwaters soar long distances by making

GLIDING AND SOARING

use of the rising currents of air at the surface of the water caused by waves.

Conclusion.—Birds are the master soarers. They are built for stability and grace of flight and are sensitive to every air current. If the airplane could combine the air-worthy points of the bird, with its own tireless motor, it would be a splendid vehicle indeed!

CHAPTER XVIII

STATIC SOARING

SOARING differs from gliding in that the ship, instead of losing altitude, either pursues a level course or gains height. Wind and air currents are the only power plant which supplies the energy necessary for soaring. When you are able to take off, land, and effect turns in simple gliding with ease, you are prepared to attempt soaring.

Simple gliding may possibly be successful even if the pilot is not under the direction of an expert instructor. But, in order to learn to soar, the student must have instruction, both in the way to fly the glider, and in meteorology.

What Is Static Soaring?—The aim of all soaring is to store up potential energy whenever the wind supplies it in excess of the amount necessary to propel the glider. This potential energy may take the form either of altitude above the earth, or of superfluous forward speed. Static soaring is gaining altitude by means of energy supplied by upward wind or air currents. Although altitude is gained (or at least maintained) during a soaring flight, soaring is in reality a form of gliding; *i.e.*, the normal attitude of any glider (of which the soarer is one form) whether it is sliding downhill, remaining level, or rising, is at an angle of glide. This is the gliding position which results in giving the ship its momentum and allows it to maintain flying speed. But when soaring, though at an angle of glide, the plane's downward movement is only so in relation to the airflow over its wings; if the whole body of air ascends, in relation to the ground, the soarer may actually be gaining altitude. This distinction between the soarer's path through the air and

its height above the ground may be compared with the case of a small boy who walks down an upward moving escalator: he is constantly going downstairs, but actually may stay at about the same distance from the bottom.

Effect of Upward Currents on a Soarer.—If the velocity of the upward current of air equals the glider's sinking speed, the glider flies forward at a fixed altitude; if the rate of the upward current exceeds the ship's rate of descent, the glider gains height. If the current is exactly vertical, its entire velocity may, theoretically, be utilized by the soarer; few currents are, however, exactly vertical. The more nearly the direction of the upward current's movement approaches the horizontal, the less lifting effect it has upon the glider. That portion of the current which exerts lifting force upon the ship is called the "vertical component" of the wind.

For example, if a wind were blowing at 35 feet per second up the side of a hill having a slope of 1 in 7 (*i.e.*, a slope rising 1 foot to every 7 feet of horizontal distance), its vertical component would provide a lift of 5 feet per second. If the ship's forward speed were 35 feet per second and its gliding angle 1 in 7 (*i.e.*, if it would lose a foot of altitude to every 7 feet of distance traveled when flying in still air), then the ship would remain at a fixed altitude. Or, if the glider were moving ahead through the air at 40 feet per second instead of 35 feet, and other conditions remained the same, the ship would be making 5 feet per second headway against the wind, and losing altitude gradually. (If the angle of glide were less than 1 in 7, the soarer would gain height.)

Suitable Locations for Soaring.—Static soaring is usually done on the windward side of hills; and hilltops provide good places from which to take off. Thermal upward currents are not so useful for short soaring flights. Figures 98 and 99 show soarers in flight.

STATIC SOARING



FIG. 98.—A soarer in flight over the Bavarian Alps. Upward currents over terrain like this supply great potential energy.



FIG. 99.—The Bavarian Alps are an excellent laboratory for the soarer pilot. Only skilled glider pilots should attempt flight over mountains and clouds.

GLIDING AND SOARING

You should make your first soaring flights in a wind which is comparatively steady and not too high. The strongest part of the upward current occurs a little distance away from the side of the slope, so that you must acquire a fairly good impetus from the take-off in order to reach it. The velocity, and consequent strength, of the vertical current decreases with increasing altitude. If the wind is high, however, the current may be strong enough to support the glider at an altitude twice the height of the hill.

You must avoid the leeward side of hills or mountains, since treacherous eddies and descending currents exist there.

How to Make Use of Upward Currents.—As soon as you have reached the maximum peak of your launching put the ship into its most efficient angle of glide. This angle will depend a good deal upon the speed of the wind and the sensitivity of the soarer. If you have never flown a soarer before, remember that this angle is less than that of ships of lower performance. The soarer will probably assume the correct position of its own accord, if you abandon the controls for a moment.

Under ordinary weather conditions, you will not be able to tell from the feeling that you are soaring, since the ship's movement through the relative wind is similar to that when it is simply gliding downhill. But you will soon be able to tell whether or not you are soaring by observing your height above the starting place.

When you have glided away from the hillside for a time, you will pass the zone of greatest effectiveness of the upward flow of air, so that you will be obliged to turn and fly back toward the hill. The point at which this turn should be made depends upon the velocity of the wind and the steepness and contour of the slope. You will be able to find it by watching the side of the hill until you see that you are losing height. It is advisable, before you start your flight, to talk with some one who has soared beside that particular elevation under various weather conditions. If you watch

STATIC SOARING

birds flying along a mountain ridge, you will notice that they weave back and forth close to the windward slope, in order to remain within this zone of strong upward current.

Static soaring may be effected for long periods at a time by making circles on the windward side of a mountain peak, or by performing S-turns along a ridge. It is also possible, however, to glide from one upward current through still air to another upward current, as long as the wind is strong enough and the peaks high enough.

Diving and Climbing.—The normal angle of glide is usually the most efficient of all positions in which a glider may be soared. But sometimes other maneuvers are either expedient or necessary, and you should practice them in order that you may be able to perform them when the occasion arises. Diving and climbing are both elementary feats, but they are usually impossible except during soaring, since they require a good deal of altitude. Of course, a glider climbs after it has been catapulted into the air, or when it is being towed; these are merely exterior sources of energy.

Diving is accomplished by pushing the stick forward, so that the chord of the wings forms a negative angle with the horizontal. During a dive, the ship is moving at a rate greater than normal flying speed, so that it gathers additional impetus. This stored up kinetic energy enables the ship to turn and climb at the end of a dive. In order to climb, you must pull the stick back, thus increasing the angle of attack so that it is greater than the normal angle of glide. Climbing is possible only when the glider has stored up energy from some source; as soon as this energy has been used up, the ship must turn to its gliding attitude or it will stall.

Conclusion.—Once you have grasped the fundamental principles, you will find the theory of soaring easy. But in

GLIDING AND SOARING

practice, successful soaring requires great experience. You must become thoroughly familiar with your ship, the region over which you are flying, and the most efficient way of making use of upward currents, before you will be prepared for dynamic soaring or long-distance flights.

CHAPTER XIX

DYNAMIC SOARING AND ADVANCED MANEUVERS

WHEN you have had considerable experience in static soaring, you are prepared to attempt some advanced and experimental maneuvers. Dynamic soaring is a science about which little is yet known, but which may have possibilities of being developed so that the motorless plane will be as efficient as the soaring bird.

What Is Dynamic Soaring?—Dynamic soaring is done through gaining potential energy in the form of excess speed from variations in horizontal currents of air. (Static soaring, it will be remembered, depends upon upward currents.) Mr. William H. Bowlus defines the difference between static and dynamic soaring in this way:

Static sail-flying is limited to the landscape, that is, dependent on it; whereas dynamic sail flying is based on the utilization of the inner energy of the wind, in which are turbulent air currents, inversion layers, and the like.

A kite, or a glider which is being towed, can utilize the energy of a horizontal wind; but a soarer, since it relies upon its own inertia for its forward movement, cannot do so, as long as the wind remains steady. It has, however, been found possible for the soarer to derive energy from changes in the velocity and direction of a horizontal wind.

How to Make Use of Variations in Velocity of Horizontal Currents.—Theoretically, a soarer should be able to make use of the fact that different strata of air travel at different speeds: coming from a slow stratum into a faster one, the

GLIDING AND SOARING

glider would have sufficient inertia to continue to travel forward, at the same time gaining lift. But, since the boundaries between the strata are almost impossible to discover, by any means yet available, and since it takes time to maneuver the glider, it has so far proved impractical to make use of the varying velocities of different layers of air.

It is, however, possible to soar by means of the variations of velocity in any single stratum. When you are flying in a "gusty" stratum in the direction opposite to its direction of travel, any increase in its speed above the mean velocity will seem to you like a puff of air from the front, any decrease in speed like a puff from behind. In order to make use of this gustiness, you must glide ahead for several seconds in order to get some idea of the intervals at which the gusts occur. Then, as long as the wind is freshening (*i.e.*, as long as the puff of air strikes you in the face), your own inertia will carry you ahead, and you can avail yourself of your increased air speed by pursuing a practically horizontal course. Before the gust reaches the apex of its speed, however, you must turn about so that you fly in the opposite direction. In this way, you are able to avail yourself of what is equivalent to a puff of wind from the other direction, although in reality it is merely a slowing down of the entire gust.

If it were possible for the soarer to turn instantly every time the gust reached its highest speed, and every time it reached its lowest speed, this type of dynamic soaring might be practiced to great advantage. But the gusts come and pass again in so few seconds, that the glider must waste most of its time and its forward speed in turning about; and, furthermore, it is impossible for the pilot to foresee when the gust will reach its maximum velocity. In spite of these obstacles, skilful soarer pilots have been able to gain some advantage from this means of flight.

Other Uses of Frontal Gusts.—Although it is possible to use variations of direction in horizontal currents, these

DYNAMIC SOARING AND MANEUVERS

variations are, at present, of little practical importance. Frequently, however, variations of a frontal wind are combined with upward currents of air; and this combination may be very useful to the adept pilot. For instance, if you are flying in a horizontal current and in line with the direction of its movement, and if you then encounter an upward current which has no horizontal velocity, you can pull your stick back to get the full value of the rising air, while keeping flying speed because of your great momentum.

Although little progress has yet been made in dynamic soaring, every soarer pilot should learn as much as he can about it, in order to have a foundation for his own experiments.

Maneuvers and Acrobatics.—While the acrobatics possible to the powered ship, due to its great speed, strong construction, and controllability, are rarely practical for the glider pilot and usually impossible, there are certain maneuvers which the glider pilot often uses and which he may safely practice. They are not dangerous, as long as they are performed at a sufficient altitude to ensure recovery from them. A soarer, however, is very delicate, with little to spare in the way of a safety factor if put to undue strain, and it will be literally the “stunt” flyer who attempts stunts in one.

All acrobatics, of course, have an experimental value. They require a high degree of maneuverability on the part of the ship, and a knowledge of the ship's reaction to them is important to the designer. It is possible that greater perfection of design will make the soarer pilot more efficient in the performance of stunts, and may provide, in some degree, that agility which is necessary for successful dynamic soaring.

The type of maneuvering you can do in a glider is interesting and instructive, and its practice will accustom you to recovering from all sorts of unusual positions, so that you will always be prepared for any emergency into which sudden wind changes may throw you.

GLIDING AND SOARING

Intentional Stalls.—If you are a skilled pilot, at a good altitude, and in a ship of high performance, the practice of a few intentionally induced stalls is profitable and not dangerous. By practicing stalls, you will become accustomed to the feel of the controls when they have “gone out” (*i.e.*, become useless through the loss of flying speed), and to the method of recovery. The best way to stall the glider is to pull the stick back while you are in straight flight. The nose will rise for a moment, but eventually instead of

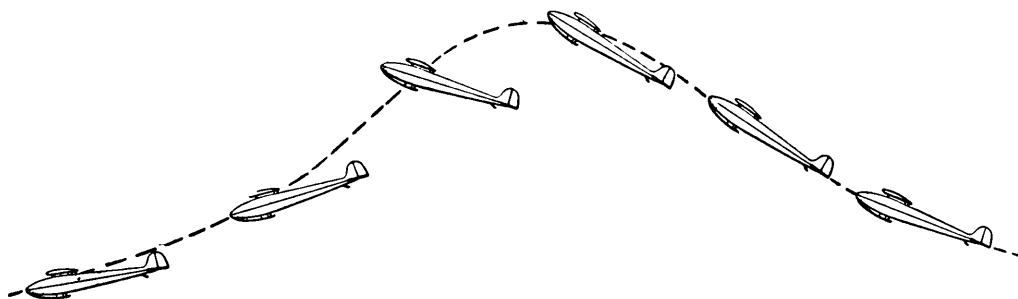

FIG. 100.—Movement of glider during stall. The dotted line shows path of plane going through stall.

climbing, the ship will “squash” downward through the air. The pilot’s weight will tend to force the nose down again. In order to recover control, push the stick, way forward; the resultant dive will allow the ship to regain flying speed. The movement of the glider during a stall is shown in Fig. 100.

Side-slips.—A side-slip is the same thing which you were warned against in making turns, occasioned by insufficient rudder in proportion to the amount of bank. As a means of losing altitude for a spot landing, however, it is very useful. In order to slip the glider, bank the ship—into the wind if possible. At the same time, apply the opposite rudder. Before a side-slip, it is necessary to dive in order to gain speed; and the stick must be held forward during the slip to prevent a stall. Do not allow the glider to slip for more than a few seconds. To recover normal position, centralize the controls. A side-slip allows you to lose considerable

DYNAMIC SOARING AND MANEUVERS

altitude without traveling much distance over the ground, (see Fig. 101).

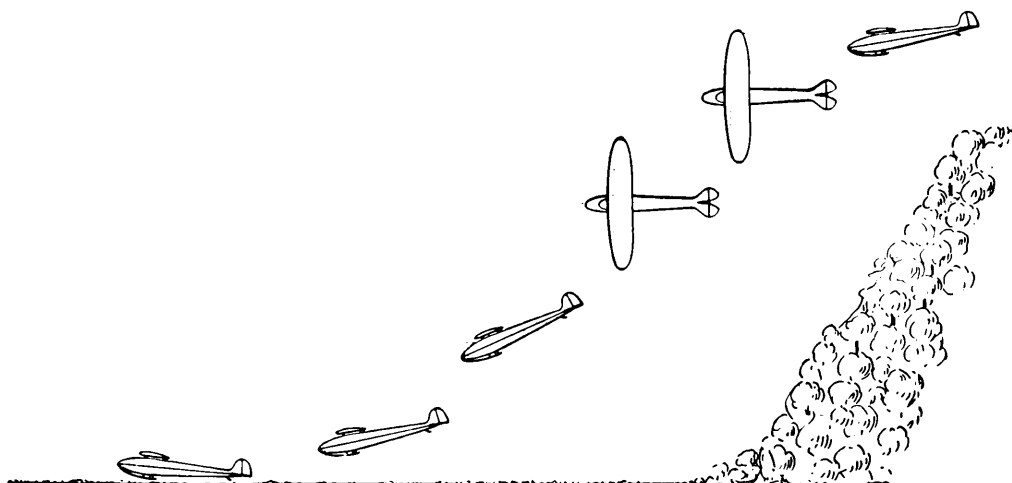

FIG. 101.—A side-slip to a landing.

Spins and Loops.—Such maneuvers as these pass the border of plain flying and become stunts. In only a few

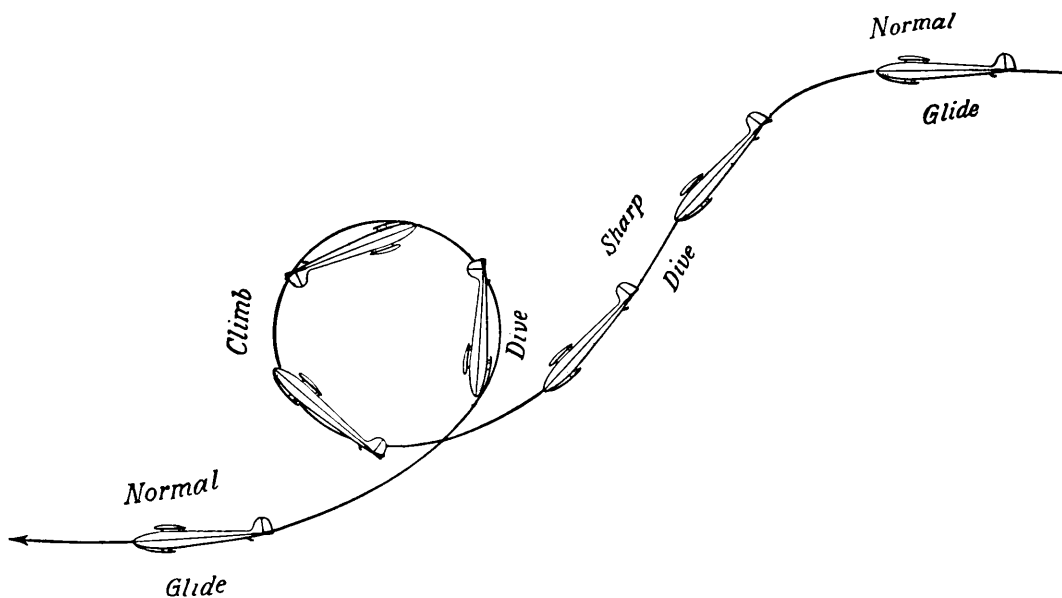

FIG. 102.—A loop. This diagram shows the glider's path of flight during one of the most hazardous of stunts.

cases are they attempted by the glider pilot. The spin may be the result of a prolonged stall, or it may be caused more quickly by a skid. Successful loops have been executed in

GLIDING AND SOARING

gliders, but they are extremely difficult, since they require great speed and an altitude of at least 3,000 feet; and there is little to be gained from them (see Fig. 102).

It is extremely unlikely that a glider will ever be banked steeply enough to necessitate the use of reverse control. If a bank approaching 90 degrees should ever be made, however, you should remember that the functions of the rudder and the elevators become reversed, in relation to the horizon.

Conclusion.—Dynamic soaring is difficult. It presents an infinite field for experimentation and research. You should begin to experiment with it as soon as you are able, whenever you have the opportunity. Comparatively simple maneuvers such as those described may also be undertaken as soon as you are able to reach sufficient heights. Stunts or acrobatics, however, are best left to the man of great experience in the air.

CHAPTER XX

DURATION AND LONG-DISTANCE FLIGHTS

THE object of a duration flight is to remain as long as possible in the air, usually quite near the take-off. The aim of a long-distance flight is to fly as great a distance as possible. Many long flights have been made within the past decade. Many of these have established new records in their fields. Most of them have contributed to the scientific knowledge of the air and all have materially increased the experience of the individual pilot.

Before you attempt to make a long-distance flight, you should know how to read instruments; you should be familiar with the surrounding region; and you should be able to recognize the weather conditions suitable for such an attempt.

The Value of Instruments to the Soarer Pilot.—There are a number of different aeronautical instruments, but many of them are not in use on gliders. Usually those which a glider needs are those to show height, speed, relation to the horizontal, and compass heading. Most instructors think that beginners should not use instruments, since they are apt to grow too dependent on them; student pilots must learn to fly by the “feel” of the controls, and by detecting currents of air which strike the ship. Expert pilots, who are prepared to make long flights, are, however, often obliged to use instruments. Especially in night flying or in jumping from cloud to cloud, when the horizon is often imperceptible, instruments are indispensable.

The Instrument Board.—Primary training gliders are seldom equipped with instruments. Secondary training

GLIDING AND SOARING

gliders occasionally have them. On ships of high performance the instruments are fastened to an instrument board which is attached to the fuselage immediately in front of the pilot. The figures and letters on the instruments should be so large and clear that they may be quickly read by the pilot.

Stability or Flight Instruments.—The instruments used on soarers may be divided into two classes: stability or flight instruments, and instruments for navigation. The most widely used instruments of the former class are:

1. *Altimeter.*—An altimeter is an instrument which shows at what altitude the ship is flying. It may be so set as to

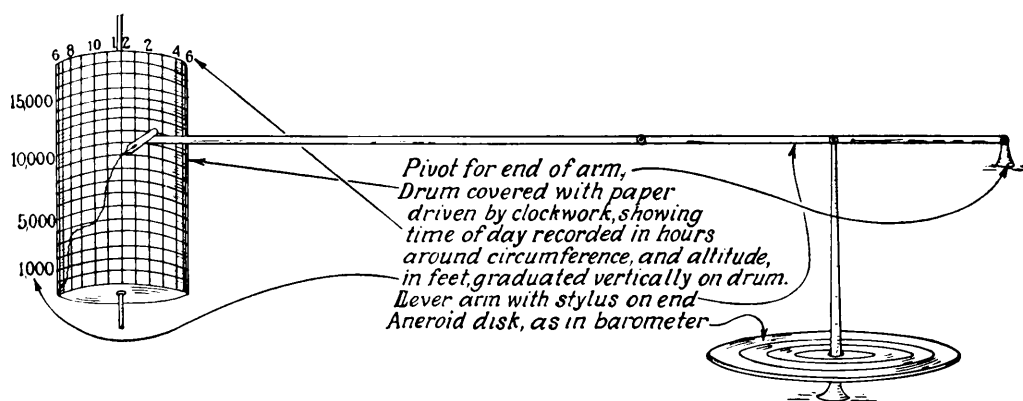

FIG. 103.—Diagram of essential parts of a barograph.

register the height above sea level, but usually is set to register zero at the valley level over which you are to fly, in contradistinction to that of a motored plane which is set at the level of take-off. The indicator on the dial is commonly moved by an aneroid barometer. This barometer expands with increasing height as the air grows thinner, and contracts as the height becomes less and the air denser.

2. *Barograph.*—The barograph gives a continuous record of the altitude registered by the altimeter, so that, at the end of the flight, the pilot has a complete record of the heights which he has gained and lost. On test or prize flights

DURATION AND LONG-DISTANCE FLIGHTS

this record will be sealed by the judges at the beginning and opened by them at the end of the flight. Figure 103 explains the way in which a barograph works.

3. *Bank Indicators*.—There are several types of bank indicators. They do not show at what angle the ship is banked, but whether it is correctly banked, whether it is skidding or slipping. One form of this instrument consists of a small piece of glass tubing, in a horizontal position, containing a bubble of air, or a tiny metal ball. As long as the ship is flying level or is banked properly for the speed and degree of its turn, the ball or bubble remains in the center of the tube; but when slipping or skidding occurs, the ball or bubble rolls to one side.

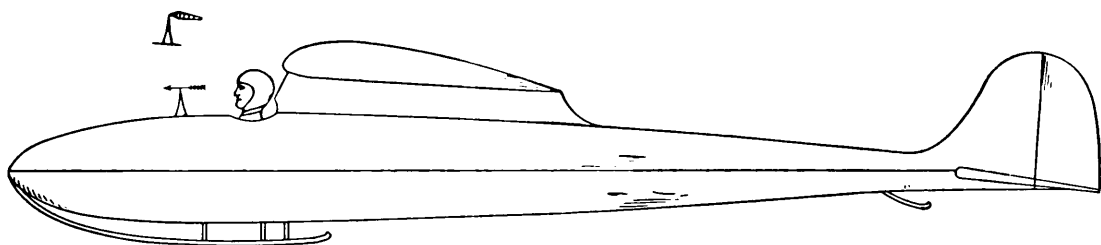

FIG. 104.—A tiny vane or wind sock indicates a slip or skid more conveniently than an inclinometer. This vane may include a whistle which indicates any change of speed by a change of note.

Another indicator which gliders alone use is a small weather vane or wind sock attached to the fuselage right in front of the pilot (see Fig. 104). This is really a yaw meter and registers one's deviation from a path directly into the wind, as well as the presence of those side gusts of air occasioned by skidding or slipping, which the pilot may not feel distinctly against his face.

4. *Air-speed Indicator*.—No instrument for easily measuring ground speed has yet been invented; furthermore, it is air speed in which the glider pilot is particularly interested. An air-speed indicator measures the pressure of the relative wind, and records this pressure on a dial

GLIDING AND SOARING

graduated according to miles per hour. The pilot can tell from this instrument how much kinetic energy in the form of excess speed he has stored up, *i.e.*, how far the soarer is from the stalling point.

Instruments for Navigational Purposes.—These instruments are important for long-distance flights. The only navigational instrument ordinarily used on the glider is the compass. Although there is more than one type of compass, the usual magnetic or mariner's compass is the one best suited to the glider.

1. *Compass.*—A magnetic compass consists of a freely suspended magnet, usually mounted on a card. The magnet points toward the magnetic north. A magnetic compass is made temporarily ineffective by a bank of about 20 degrees. Therefore, before reading the compass, the pilot should maintain straight flight after a turn, until the needle ceases to swing from side to side.

When you wish to use a compass with any degree of exactness, you must correct it for *variation*. This variation is due to a difference between the magnetic, or true, pole of the earth, and the geographic pole which has been arbitrarily located by scientists. Charts may be obtained explaining how to correct for variation in different parts of the world.

Suitable Clothing for Long Flights.—In making preparations for a long flight, you should have the proper clothing. Although it may be warm and sunny when you take off, weather conditions often change with surprising celerity. Cabin gliders (*i.e.*, gliders with enclosed cockpits) have been built; but they are uncommon. Ordinarily, the pilot is exposed to the air; the wings on most gliders offer only slight protection from possible rain. Waterproof coveralls, of light weight for summer, and of warmer material for winter wear, are an excellent form of clothing. In cold weather, you should have lined boots or overshoes.

DURATION AND LONG-DISTANCE FLIGHTS

Mittens are the best covering for the hands, and they are not too great a handicap in maneuvering the ship.

A helmet and goggles, such as are usually worn by motored-plane pilots, are sometimes used by soarer pilots when they start out on long flights. If you are accustomed, however, to recognizing wind currents by blasts of air against your face, you may find such head covering an impediment.

Other Provisions for Long Flights.—You should have all possible accessories for your comfort, as well as the proper clothing. The constant alertness, watching for air currents, and the strain of maneuvering the ship for hours at a time, are very wearisome. Some pilots have been obliged to land, while the soaring conditions were still good, on account of fatigue. Therefore, cockpits should be made as comfortable as possible (although they may be conducive to sleep unless they force the pilot to sit fairly erect). Moreover, you should take some food. Dinort, a German flyer, says that the most satisfying lunch, and one which does not weigh too much, consists of two sandwiches, two cakes of chocolate, and a bottle of lemonade. In cloud flying, flying over mountainous terrain, or airplane towing, a parachute is advisable as an additional safety factor.

Preliminary Study of Map.—Before setting out on a long flight, you should become thoroughly acquainted with a map of the surrounding region. The map should be as large and as detailed as possible, without being unwieldy. You indicate on it all places where upward currents are known to exist. With this information, you can plan beforehand what course to follow, and what means may be used, under various weather conditions, to move from one upward air region to the next. It is advisable to know what sections of the terrain are impossible as landing places, in order that you may avoid them.

GLIDING AND SOARING

Familiarity with the map of the entire surrounding region, as well as with those routes which you hope to be able to follow, is advisable. It is quite possible that you may discover useful air currents in unexpected places, or that you may be forced out of your intended course.

You should keep this map with you during your flight. By comparing it with landmarks on the terrain beneath, you will be constantly informed of your whereabouts.

Preliminary Study of Weather Conditions.—When everything is in readiness, you may be obliged to wait until weather conditions are propitious for a long flight. What these weather conditions must be depends a good deal upon your knowledge of the various methods of soaring and your ability in handling the glider. But, in general, there must be a good wind, and no danger of precipitation in the form of snow or ice which might cling to the ship. Sunshine usually produces an abundance of thermal upward currents which may be of use. On the other hand, storms supply plenteous and sometimes violent energy which some pilots have been able to transform, without harm to themselves or to their ships, into soaring energy. But unless you are very experienced, and have a strongly built ship, you will do well not to brave such furious conditions of the elements.

The Ground Force.—One way to aid your flight is to maintain a force of assistants on the ground. A great number of duties may be delegated to it.

The members of the ground force may be stationed at intervals along the intended course of the ship. A good part of the time, they may be able to call to the pilot from the ground; but, if the soarer is flying high, they will be obliged to use some method of signalling. Probably the commonest method of signalling is by semaphore (see Fig. 105). Light radio sets have been used in America.

In night gliding, a ground force is particularly necessary.

DURATION AND LONG-DISTANCE FLIGHTS

How to Make a Duration Flight.—Once you have started on a flight which you hope to prolong for hours, you will be able to maneuver the ship in the same way as during short hops, because you customarily remain in the air above approximately the same place. Nevertheless, you will probably use more than ordinary precision in order to obviate the possibility of mishap.



FIG. 105.—A German soarer starting out on a long-distance flight. This is one way of signalling to the pilot from the ground.

Duration flights are usually made by making figure 8's along a ridge. This is a comparatively simple process, since it is so repetitious. But, because of the very repetition, you must remain constantly on your guard. By heading in one direction a little too long, you may pass the zone where the upward currents are most powerful, thus losing a good deal of altitude. Moreover, the wind is apt to change quite suddenly, and you must watch both its direction and its velocity.

How to Make a Long-distance Flight.—Long-distance flights are more difficult than duration flights, because the conditions are constantly varying. This calls for great alertness. The more familiar you are with the air, and the

GLIDING AND SOARING

more kinds of wind currents you are able to make use of, the more successful you will be at long-distance gliding. Long-distance flights ordinarily are made by going as far as possible without any loss of altitude, and then, if feasible, by returning over the same ground.

Night Gliding.—Comparatively little attempt has been made to glide at night. This is probably due more to the comparative calmness of the night air than to the darkness.

Some notable night flights have been made, however, such as those made by Bowlus, and by a German named Dinort, who made a duration flight of 14 hours and 45 minutes. The row of peaks, above which Dinort was gliding, was well lighted by a ground force. Twin lights were placed at either extremity of the range, and single lights marked the intermediate summits. The guards, who were stationed to watch the lights and to make meteorological reports through megaphones to Dinort, worked in shifts of 3 hours each. They found that oil lanterns gave a more diffused and, therefore, a more satisfactory light than flashlights. But the lamps would not give a constant light because of the high wind, so that flashlights had to be used to supplement them, whenever the ship approached the ground. The guards experimented with large mirrors to reflect the lights, but this was unsuccessful because the swirling sand soon destroyed the mirrors.

Dinort reported that the darkness made him lose the feel of the controls; he had difficulty in maintaining his course, since he had no instruments. For this reason, night glides should not be made without instruments. The visibility is especially poor at twilight and at dawn. At those times, also, the wind is apt to die down.

Better lighting devices than those used by Dinort's guards are available in most places. A row of automobile headlights will illuminate a wide expanse of fairly level ground. Beacons, like those used in airports, shoot streaks of bright light through the air. Gliders might, without great

DURATION AND LONG-DISTANCE FLIGHTS

increase of weight, be equipped with small wing-tip lights. In landing, the pilot might drop a small flare, supported by a parachute, to light the ground.

Conclusion.—Duration and long-distance flights are an extremely important phase of gliding. Most people have a strong competitive spirit and are incited by the possibility of making new records. (In America no records are official unless made in the presence of judges approved by the National Aeronautical Association.) Moreover, since a pilot who is attempting to make a long flight will resort to almost any means in order to remain in the air, he is very apt to discover new methods of soaring. A great many of the advances in soaring have been made during record flights.

PART FIVE

CONSTRUCTION

- CHAPTER XXI. Model Building
- CHAPTER XXII. Preparing for Glider Construction
- CHAPTER XXIII. How to Build a Glider
- CHAPTER XXIV. Maintenance

Part Five describes the methods by which various types of gliders may be built and serviced. It is accompanied by a number of detailed drawings of the essential parts.

Chapter XXI discusses model building, and gives suggestions for the construction of a model glider; model building is a great aid to the designer and to the person who intends to build a full-sized plane. The purpose of Chap. XXII is to tell the reader what kind of a shop to work in, what tools and equipment he will need, what materials to buy, and how to enlarge the plans to obtain full-sized dimensions. Chapter XXIII describes several methods of building the various components of a glider. Chapter XXIV gives directions for the maintenance of the ship after the parts have been built; it tells how to transport, rig, test, and repair the glider.

CHAPTER XXI

MODEL BUILDING

YOU can learn a good deal about gliding by building and flying model gliders. The construction of models teaches you much concerning the parts of a glider and the aerodynamic qualities which allow the glider to stay in the air. Model building is not for amateur flyers alone: airplane designers test their plans on a small scale, before they invest time and money in building a full-sized ship. Moreover, models are sometimes used in testing the winds prior to soaring flight.

Model Gliders Made for Purposes of Construction.—There are, in general, two types of model gliders: those made to

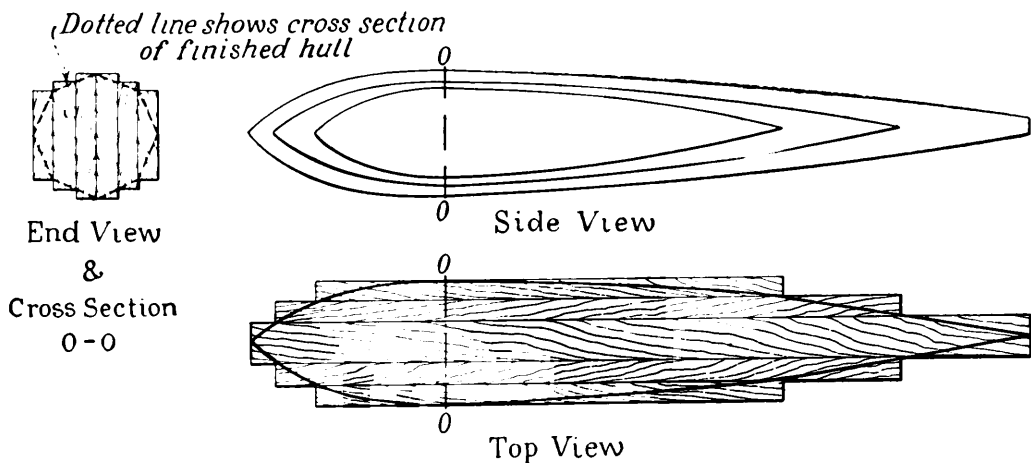

FIG. 106.—The fuselage of a model built for construction purposes. This shows how a model fuselage is built up of a number of boards glued together. It, of course, makes the glider too heavy to fly.

show construction or form, and those intended to fly. One derives the same sort of pleasure from building the first type of glider, as from rigging a clipper-ship model. Such a glider may be a detailed copy of a real motorless plane,

GLIDING AND SOARING

with a pilot's seat, and a rudder bar and stick which actually move the control surfaces, etc. The wings may be made of cloth or paper, stretched over wooden framework. Others, of course, are made of solid wood. Thread may be used to simulate wire if the parts are made immovable. In such a model, you can use various accessories, such as tiny turn-buckles to tighten the wires, since additional weight makes no difference. This glider will, of course, not fly, and is only to be looked at, but you will gain a lot of constructional information by working on such a model. Figure 106 shows a very good way of building a fuselage for such a model.

Model Gliders Made for Flight Purposes.—Glider models intended actually to fly vary from the simplest to the most complicated. The simplest type of thing you can build consists of a straight narrow piece of light wood as a fuselage, with a supporting surface of wood or of cardboard at one end for wings, and a smaller surface at the other end for elevators. These will usually be built up to have a slight camber or curvature, rather than a perfectly flat under surface (see Figs. 107 and 108). By adjusting these supporting planes until the ship is perfectly balanced, you will learn something of the aerodynamical principles of balance and of the relationship between the center of pressure and the center of gravity. In order that the planes may be easily adjustable, they may be fastened to the fuselage with rubber bands, rather than nails or glue.

Directional stability is, of course, impossible without the addition of some kind of fin or rudder. Figure 107 shows a commercially manufactured model of this type, but you can easily make one. Such models as these are flown in reverse fashion; that is, the fin is placed behind the wing and the stabilizer in front of it so that the model is put into the air with the stabilizer in front. This is a rather common type.

Simple glider models may be made of heavy paper strengthened by thin strips of wood, may be covered with

MODEL BUILDING

light-weight cloth, or may be made entirely of wood. Any wood may be used, but soft wood is preferable. Balsa wood is probably the lightest known and is ideal for model

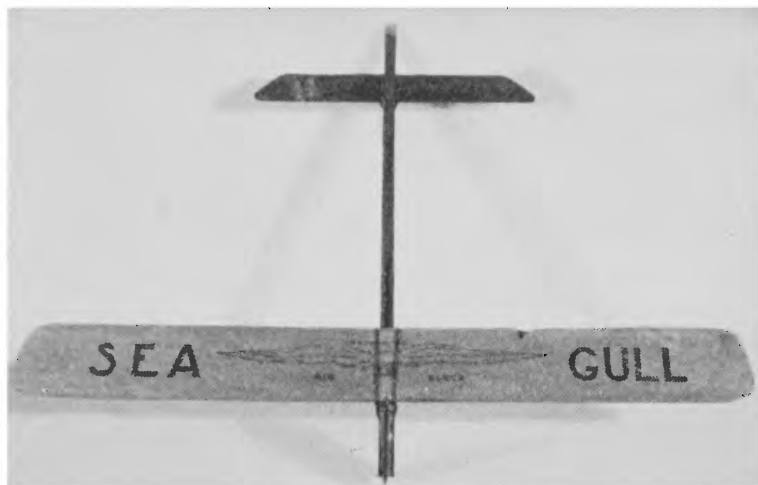

FIG. 107.—A model built for flight purposes. The planes are attached to this model by means of rubber. Thus, the planes can be easily adjusted, until the glider is perfectly balanced. This model flies elevators first, *i.e.*, in the opposite position from a real glider.

purposes, either in strips or in whole surfaces. Sometimes strips of thin, light-weight metal are used. Aluminum is

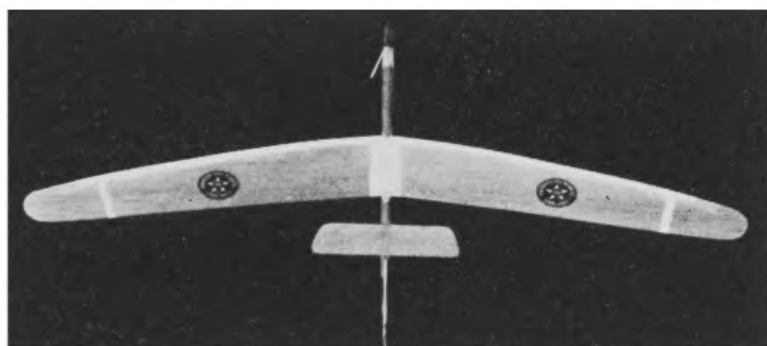

FIG. 108.—A less simple type of model. This model is built of light wood. The perfect balance and the sweep-back of the wings allow the glider to fly long distances, and to execute turns and other maneuvers.

available in thin sheets, as is magnesium. The latter is extraordinarily light and comes in various sizes of wire, also. The wings may also be made entirely of such metal,

GLIDING AND SOARING

but they are apt to bend when the ship strikes the ground, and are usually unsatisfactory.

When you have experimented with simple models, begin to make gliders with greater refinement of design, and more accurately built.

The model sailplane similar to the one shown in Fig. 108, made by the American Sailplane Company, is described by the manufacturer as follows:

It is made of solid balsa wood and has a wing span of 6 feet 8 inches and chord of 8 inches at the body tapering slightly toward the wing tips. The overall body length is 30 inches and the complete model weighs 3 pounds with a wing surface of 4 square feet. The center of gravity is well forward and the nose is loaded with lead. The body is well streamlined. The tail structure is very short and light. The elevator is set close to the wings and at a negative angle. The wings are swept back slightly with a deep camber near the body which gradually washes out into a thin flat light negative wing tip. They are also set at a slight dihedral angle.

Several flights of a mile or more have been made with this model, when flown from an elevation and launched into a moderate rising wind, the model retaining its balance perfectly and soaring like an eagle. It has been made to hover motionless over one spot several seconds at a time under favorable conditions.

The model assumes the correct soaring angle, adjusts itself to different air currents very quickly, banks correctly in turning and possesses almost perfect inherent stability in flight.

The principles of stability and soaring ability embodied are results of several years of experiments with different types of models of sailplanes with the idea in mind of applying these principles to a full-size man-carrying sailplane which would be efficient, easily controlled, inherently stable, and simple and cheap to construct.

How to Fly Models.—The types of model gliders intended to be flown may be used either inside the house or outdoors. There are several ways in which a glider may be launched. Of these, the simplest is to hurl it from the hand like a javelin. Another method of launching the model is to hook its nose to the elastic of a sling shot. By pulling the ship

MODEL BUILDING

backward, then suddenly letting go, you can send it into the air exactly as you would a stone. Another way is to hold the glider in your right hand; with your left hand, take one end of a short, flexible hickory stick. Place the other end of the stick against a small block of wood glued to the side of the fuselage, and bend the stick. When you suddenly let go of the glider with your right hand, the stick will unbend, shooting the ship into the air. These methods of launching are shown in Fig. 109.

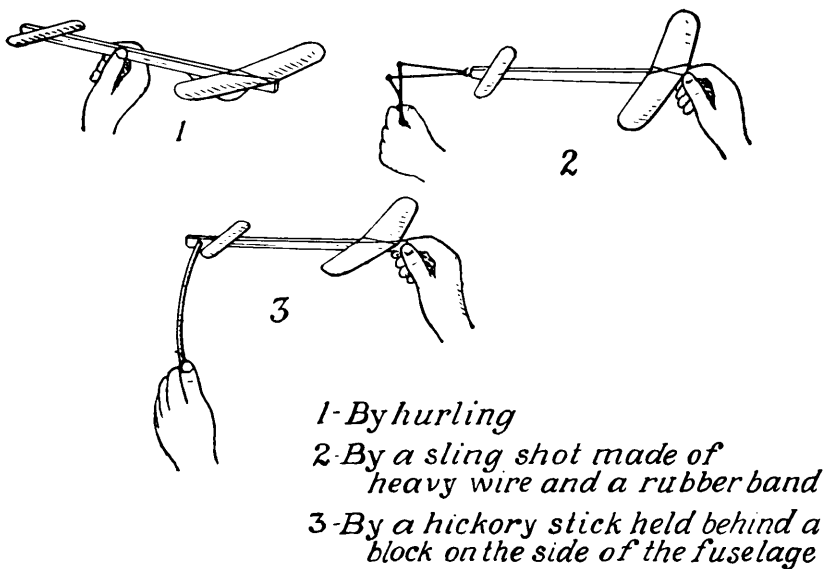

FIG. 109.—Methods of launching a model glider.

There are model gliders built so that they may be flown from kites. Such a ship can be sent to a great altitude on the end of a string, and then, if let loose from the line, will glide down. The best way to free the model in the air, is to attach the line to the glider by a hook which you can release from the ground by pulling a second string. These glider kites are made of paper alone, or of paper stretched over bent reed.

When you have launched your model glider for several straight flights, you can make it do tricks and turns in the air by setting the control surfaces.

GLIDING AND SOARING

Conclusion.—Model building is instructive, not only from the increase of aerodynamic knowledge which it brings but from the practice in delicate construction that it gives. It is also intensely interesting to perfect models and learn to handle them until, if correctly designed and built, you can make them carry out your wishes in the air. It is a real pleasure to see a tiny airship actually flying under its own control.

CHAPTER XXII

PREPARING FOR GLIDER CONSTRUCTION

THE least expensive way to procure a glider is to build it yourself, or with some friends who will help share the expense. Moreover, glider construction will teach you a great deal about aerodynamics and design. Most ground schools offer opportunities for some actual constructional work, although not usually on gliders.

The Dangers of Glider Construction.—Most of the accidents which happened to the first gliders were the result of faulty construction. A glider is an airplane and it must be built not only strongly, but according to the principles of aerodynamics. No amateur should attempt, unaided, to build a glider. Unless you have a real knowledge of construction, engineering, aerodynamics, and gliders which have been made previously, you should work under the direction, and, if possible, the supervision, of an expert. An expert in airplane construction will, of course, be of real assistance to you, if he does not try to change the design. A man experienced only in building powered ships is apt not to understand that gliders do not have to bear the strain that airplanes do. Such experts can be found nowadays in almost every large community. But be sure they *are* experts.

The Shop.—This should be preferably 30 or 35 feet long, to give room for the construction of the wings, and at least 10 feet wide, so that a wing can be set up flatways, and so that there will be room for the storage of other parts while the wings are being built. Exit from the shop should be

GLIDING AND SOARING

sufficient and convenient for the finished, assembled ship to pass through. The shop should have a good floor, since it will be used as the surface on which to assemble the fuselage, wings, and other parts. A wooden floor enables you to nail your supports. It should be heated if it is to be used in cold weather. The shop must be well lighted, with windows along one side, at least. A bench should be placed against the best lighted wall of the shop.

Equipment and Tools.—You will need the usual tools of an amateur carpenter, such as a claw hammer, a small tack hammer, chisels, saws, planes, draw knife, spoke shave, etc. In addition, it will greatly facilitate the work if you have a band saw and a circular saw, although these machines are not absolutely necessary. A band saw is useful for making profiles and molds for wings and other parts which have irregular shapes. Unless you have these saws, you will be obliged to have a good many parts got out at a mill. C-clamps are also necessary to hold the parts together while the glider is being assembled.

Materials and Accessories: Wood.—The most important of these materials is wood—metal is sometimes used as a wing or fuselage covering, but it is harder to work, more expensive, as easily destructible, and far more difficult to repair. Steel tubing is sometimes used in place of wood in the framework. One make of glider which can be bought with parts ready to put together, is made entirely of this. However, it is probably more difficult for the amateur to work with. It is essential that the wood used be of the best quality. A poor grade of wood is neither durable nor strong, and much may be too knotty to be used at all. Airplane lumber yards, which exist in most large cities, sell wood of excellent quality. Spruce is commonly considered the best material for gliders. Oregon pine may be used, although it is heavier, because it is as strong and less expensive. Combinations of these woods may be used in building a

PREPARING FOR GLIDER CONSTRUCTION

glider, to ensure lightness, strength, and durability. Some kind of hardwood, preferably ash or hickory, should be used for the runner, and $\frac{1}{8}$ -inch plywood is necessary for gussets, the box skid, and other purposes. Often airplane factories have "seconds" that will qualify as glider "firsts." Such seconds should not be used, however, unless an expert builder recommends them.

It will save time to have the stock sawed and planed as far as possible at a mill before it is sent to you. Until you get ready to use the wood, it should be kept so that the air can circulate around it, and so that it will not get out of shape. This is done by piling up the lumber on the floor, or on some other flat surface, and by "sticking," *i.e.*, by putting small strips of wood of equal thickness between each two boards to separate them. Long, thin strips can be "stuck" and fastened together with cord, so that they will not twist out of shape. Spruce is much given to twisting.

Glue.—All wooden joints should be glued. Casein glue is the best glue for glider construction because it is waterproof. It comes in a powder and should be mixed with cold water: use equal parts of glue and water by volume, or twice as much water as glue by weight. Mix only as much glue as you expect to use immediately; it becomes too old to be useful after it has stood a day.

Nails.—Since nails add considerably to the weight of the glider, you should use as few of them as possible. They are necessary chiefly as additional safety in case the glue should give way, and to secure the joints while the glue is drying. Cement-covered brass airplane nails are preferred by some, but iron nails are commonly used. So-called cigar-box nails are slim and light. You must decide upon the size of the nails in accordance with the thickness of the wood which you are using. If you are nailing a thin piece of wood onto a thick one, the nails should be about three times as long as

the thickness of the thinner piece. If you are fastening two thin pieces of wood together, it is advisable that the nails be long enough to be clinched on the under side.

Bolts.—All good plans specify the dimensions and material of bolts. It is usually better to use two or three small bolts than one large one. Three-sixteenths-inch bolts and quarter-inch bolts will probably both be necessary. Steel bolts are the best, but ordinary iron ones can be used.

Metal Fittings.—Sixteen- or eighteen-gage brass or galvanized iron may be used for many of the fittings, and can be procured at any tin shop. Pieces of steel tubing are also useful for fastening the struts to the fuselage, and to the wings. Such fittings add only slightly to the weight and a great deal to the strength of the glider and to the ease with which it can be assembled and taken apart. Some fittings can be bought ready-made from large hardware stores or from mail-order houses which specialize in airplane supplies. If you have no metal-working tools, fittings which cannot be bought can be made up to order at a machine shop.

Wing Covering.—The wing covering of gliders consists of some fairly good grade of cotton cloth, such as unbleached muslin or cambric, usually, although regular airplane fabric may be used. Heavy cotton or linen thread, and straightaway tape about an inch wide (either torn from the cloth or bought in a piece, and sold regularly for this purpose) are necessary for covering the seams in the cloth.

Dope.—“Dope” (cellulose acetate or nitrate) can be bought at hardware stores or from mail-order and aeronautical supply houses. It is better than paint because it shrinks the cloth, making it fit tightly over the framework, and because it is lighter than paint (four coats of dope add only about 3 ounces of weight per square yard). Conse-

PREPARING FOR GLIDER CONSTRUCTION

quently, ordinary paint should never be used. At least three coats of dope should be given to the wings. Dope is best put on by means of a paint sprayer, although it can be done with a brush. Doping adds greatly to the strength and rigidity of the wings and fuselage.

If it is mixed with some sort of pigment, dope excludes the light, and light has an adverse effect on dope. For this reason, dry aluminum powder is often added to the last two coats of dope which are applied. The aluminum gives the cloth a silver appearance. Record soarers are sometimes tinted red or orange, so that the official observers may follow them easily.

If the fuselage is not covered with cloth, it must be protected in some other way from the weather. Although any ordinary paint may be used, lacquer adds the least weight. If the fuselage is painted in colors, it gives the glider a cheery aspect, and can be seen further.

Wire.—Fourteen-gage tinned airplane wire is suitable to be used in the construction of parts of the ship. Where excessive strain is put on the wire, two strands of it may be twisted together.

Choosing the Design for the Glider.—You should choose the design with the advice of some one who has good knowledge of the subject. It is a great advantage, of course, for construction experts to make their own designs: the best gliders built so far may still be improved upon.

Selection of a design should be made with reference to the purpose which the glider is to serve. Primary training gliders, for instance, are easy to handle, and, accordingly, serve admirably to train novices. On the other hand, a student soon masters the operation of the primary training glider, and demands a more efficient machine. There are a number of well-tried designs for these elementary ships. Many secondary training gliders are too sensitive to be flown by most beginners; but, since they will soar, they have a

greater field of usefulness, and some are easily handled by a clever student.

Comparatively few soarers have been built in this country, and until recently only a few pilots here were qualified to fly them. Plans for soarers are difficult to obtain, and only experts should attempt to design or build them.

Enlarging the Plan.—When you have chosen the design for the glider and obtained the plans, they should be thoroughly studied so that you are familiar with all the parts and how they fit together. Usually the plans given in the blue prints are small and must be enlarged. In this event, full-sized drawings should be made of such parts as joints, intersections, and portions of the wings at tip and base. These enlargements must be made to scale, according to the dimensions given on the blue prints.

The profile of the wing must be drawn full size. This drawing is necessary, partly because a form has to be built in the shape of the profile over which to fashion the ribs, and partly because the wing must be made exactly as the plan specifies in order to function properly. The laying out of a wing profile is a very delicate process; its various characteristics and dimensions are chosen for any given wing in order that it may best serve its special purposes. The method by which the profile of a wing is enlarged to a scale is shown in Fig. 110. All wing designs in common use are today numbered and catalogued. The catalogues, giving figures for the enlargement of each wing design, can be procured from the National Advisory Committee for Aeronautics, in Washington.

The wings of a glider of high performance are almost always tapered. Tapered wings are more difficult to construct than straight ones, but the amateur will be interested in the method of constructing them. In a tapered wing, the wing profile becomes gradually smaller from the root to the tip. Therefore, a separate pattern has to be drawn

PREPARING FOR GLIDER CONSTRUCTION

for each rib. The method of drawing these patterns from the profile given in the plan is shown in Fig. 111.

Some plans of light gliders give directions for changing the length of the fuselage or the position of the seat in

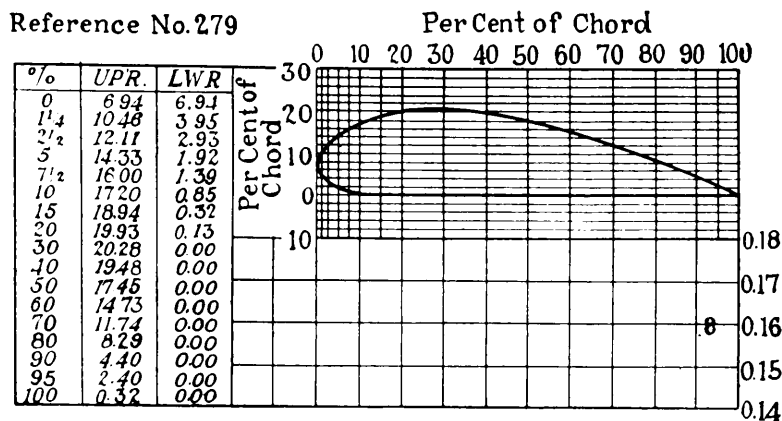

FIG. 110.—The method of enlarging the wing profile to scale. This is an excerpt, from the report of the National Advisory Committee for Aeronautics, showing a well-known wing section. The columns of figures tell how many units to measure up and down from the chord, in order to determine the profile of the wing.

accordance with the weight of the pilot who is to use the glider. You should look for such directions when you are enlarging the plans. There are some companies which make

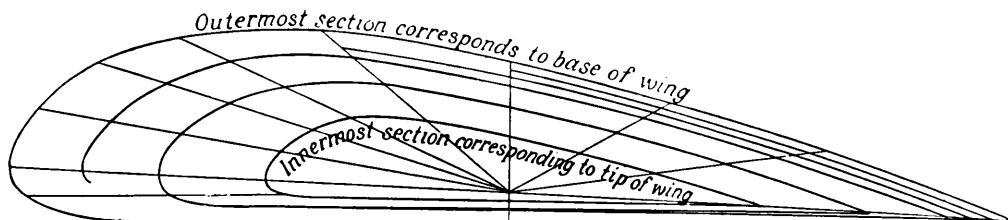

FIG. 111.—Method of laying out rib profiles for a tapered wing. The central point is at 50 per cent of chord of largest section and must also be at 50 per cent of chord of smallest section. The radial lines must pass through this central point. If there are to be 11 ribs, for example, the lines between inner section and outer section must be divided into 10 parts.

gliders and sell the parts ready for assembly. This is probably slightly more expensive but certainly is less trouble than making all the parts yourself, as well as taking less time. On the other hand, it is not so instructive and you

GLIDING AND SOARING

lose a great deal of the pleasure of carrying your building from beginning to end.

Conclusion.—Materials and tools form the chief expense in building a glider. Therefore, this equipment should not be bought until you have made a careful investigation of exactly what kind and what amount of material is needed, and where it can most cheaply and most conveniently be purchased.

CHAPTER XXIII

HOW TO BUILD A GLIDER

THE following chapter will not show you the detailed, step-by-step, engineering process of designing or building a glider. Such careful instruction involves a separate book devoted to the subject, and all that can be done here is to sketch the general procedure and to acquaint you with the process. It is essential that the construction be accurate and airworthy. If possible, you should submit your work frequently to the inspection of a qualified builder to be sure each step in the building is satisfactory before you go on to the next one. He should be, if possible, an aeronautical engineer who has made a hobby of gliders, an experienced airplane rigger, or a high school manual-training teacher with special training. During the construction work, you should also keep in touch with the nearest Department of Commerce inspector.

Once you have chosen trustworthy plans, you should follow their directions explicitly. The general instructions given here are merely to make the plans more intelligible.

To avoid waste, the different parts should be laid out on the lumber before cutting it. The working dimensions for all parts should be given on the blue prints; but if not given, you must compute the dimensions according to the scale by which the plans are to be enlarged.

As has been stated, you will need a large clear space to lay out the work. Although the profile of the wing can be laid out on a bench, the wing itself must be set up flatwise, usually on horses or on a specially built form, and must be built either on a firm floor or on trestles, so that it can be lined up with great accuracy. This is also true of the framework for the fuselage.

Wing Construction.—Essentially, wing construction consists of a series of ribs strung onto a framework of spars. Spars are pieces of wood which run the entire length of the wing. Ribs are sections built up of thin strips of wood bent to conform to the proper profile (see Fig. 112). This structure is put together by setting up the spars, lining them up carefully, and slipping the ribs over them. The ribs are glued, and sometimes nailed, into place. The whole framework is then strengthened by wooden diagonals and cross pieces, running in different directions. Diagonal wires are also used for bracing the wing structure.

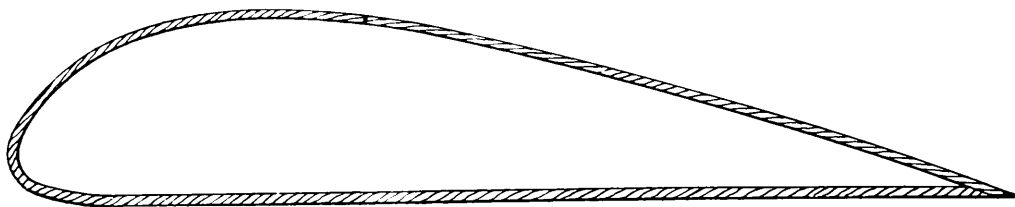

FIG. 112.—Strip which forms the rim of the rib. This is the strip of wood which is bent into the shape of the wing profile. Since this strip will not hold its shape, various methods of rib bracing are used.

Externally Braced and Cantilever Wings.—There are three types of wings: externally braced wings, semi-cantilever wings, and full cantilever wings. A cantilever wing is one in which the construction within the wing itself transmits all of the strain and stress of flight and landing from the wings to the fuselage, and *vice versa*. Cantilever wings are used on soarers and must be extremely well built. An externally braced wing is one where the struts and wires, running from the wing to other parts of the ship, transmit most of the strains. A semi-cantilever wing is one with comparatively few struts and wires, where the strains are divided between the construction inside and that outside of the wing. These three types of wing construction are shown in Fig. 113. The externally braced wing is the one used almost entirely in primary gliders. Many water gliders are biplanes and have the other form of external bracing. Usually the externally braced wing differs from the canti-

HOW TO BUILD A GLIDER

lever wing in that it has solid spars instead of lattice work, web work, or box spars. The strutted wing usually has two spars, and the cantilever, a varying number. The cantilever wing must be very firmly braced internally in order to resist torsion. The externally braced wing is much the most common, and is the one which will be described here.

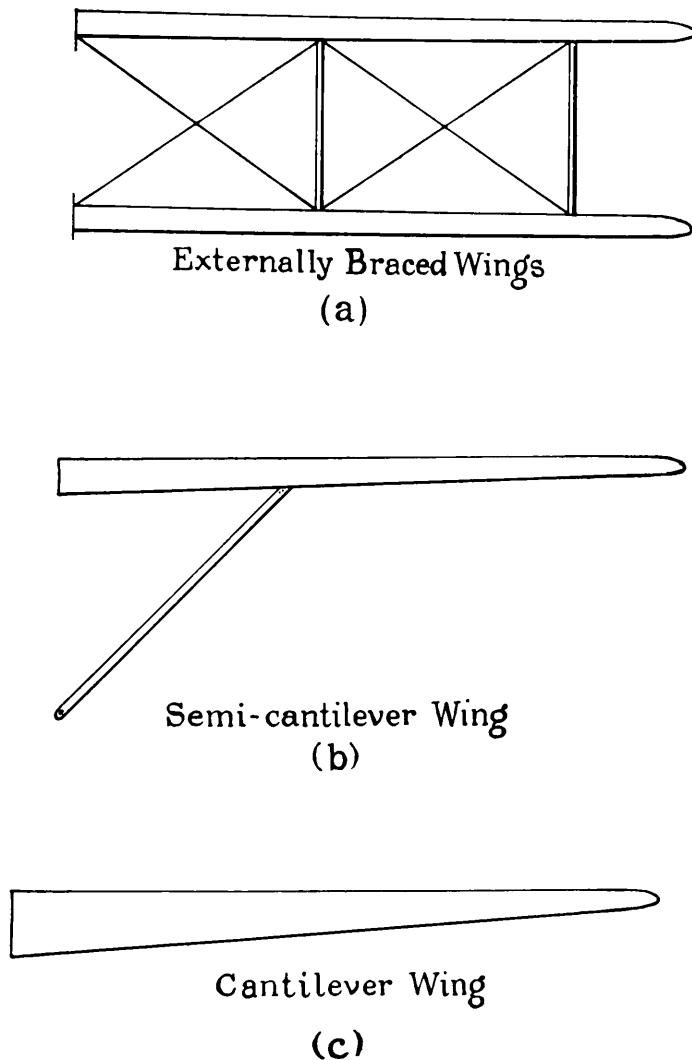

FIG. 113.—Three types of wings. (a) A good many struts and wires relieve the wing of much of the strain. (b) Has fewer struts and wires. (c) The wing itself bears all the strain.

Ribs.—The strips of wood used for a rib are bent into shape over a jig, or form. This jig consists of a board, somewhat larger than the cross-section of the wing, on which has been drawn the full-sized outline of the profile of the

GLIDING AND SOARING

air foil. Blocks of wood are nailed to this board to hold the various strips of wood accurately in position until they have been fastened together. A jig for a commonly used rib is shown in Fig. 114. The strips of wood should be steamed and forced into place between the blocks of wood.

While the rib is held by the jig, the various posts and braces must be glued into place. The Wrights used solid pieces of wood for braces, which ran vertically between the top and the bottom of the rib. This block rib is still used somewhat, and is satisfactory for primary training gliders,

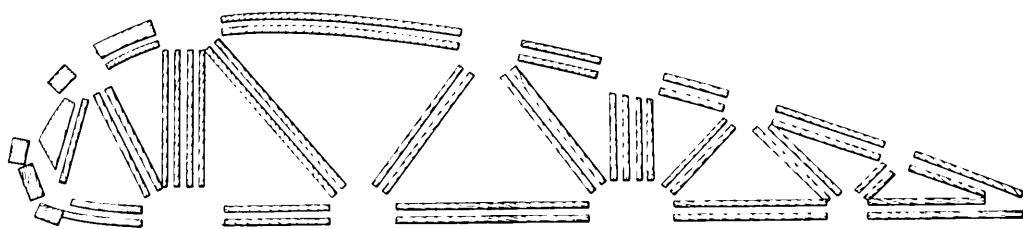

FIG. 114.—Jig for making ribs. This is the wooden form on which ribs are made, and held until the nails are put in, or until the glue is dry.

although it is very heavy and is hence adapted only to very thin wing sections. These braces are put in with glue. They are usually fastened also by nails, for the additional strength. If nails are not used, the whole rib must be allowed to remain on the jig for at least a day, until the glue is dry.

The usual method of building the internal rib braces for primary or secondary training gliders is to join strips of wood, anywhere from $\frac{3}{16}$ to $\frac{1}{4}$ inch square, to the outside rib strip by means of junction gussets. These gussets are small pieces of plywood glued, or glued and nailed, to the joints to reinforce them. The gussets may be fastened to the joints on one side of the rib only, or an additional set may be glued on the reverse side after the rib has been taken from the jig. This braced rib with junction gussets is shown in Fig. 115. Often, when the wing covering is stretched over the wooden structure, the sections of the rib rim between the posts become bent or flattened out. This is the great disadvantage of this type of rib. It may

HOW TO BUILD A GLIDER

be overcome if the rib is carefully built, and if the braces are numerous.

The rim of the braced rib with junction gussets is often made in two pieces, as Fig. 115 illustrates. In this case, the

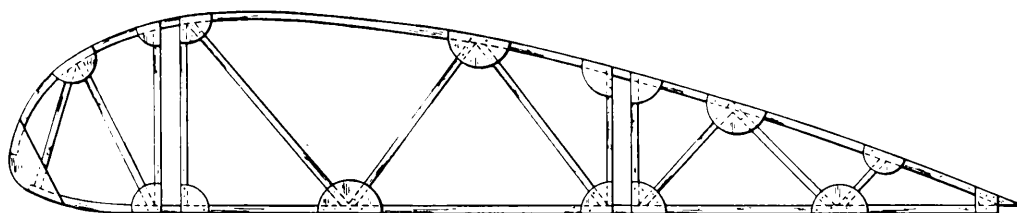

FIG. 115.—Rib finished and removed from jig. The small pieces of plywood at the joints are called gussets, and serve to strengthen the rib structure.

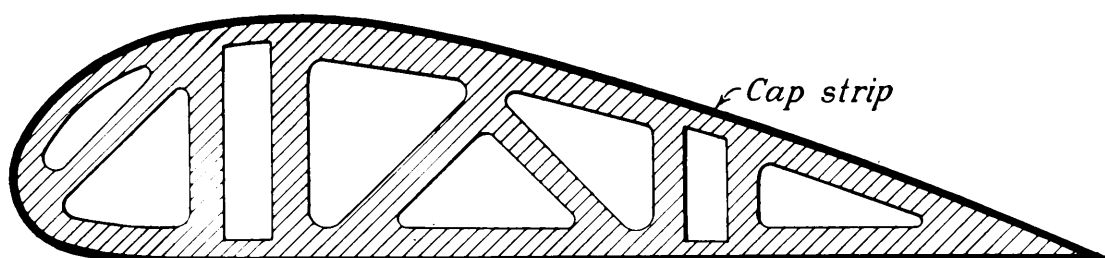

FIG. 116.—A plywood rib. The slots in the web lighten the weight of the rib. This type of rib requires a great deal of plywood, and is, consequently, expensive.

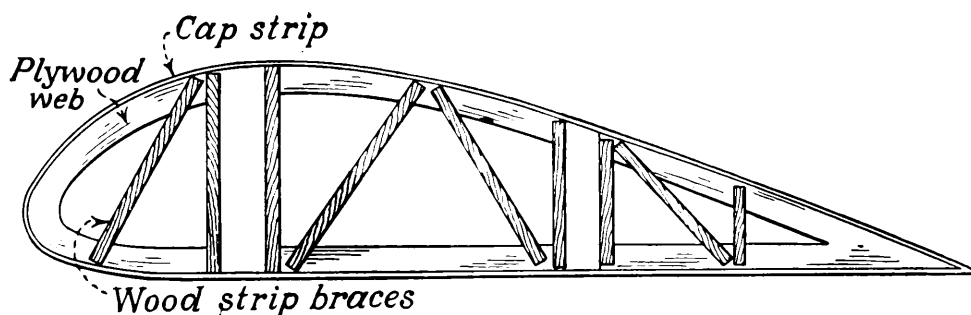

FIG. 117.—An open-plywood rib with strips of wood for braces. This rib is less expensive to build than one entirely of plywood.

strip of wood at the top of the rib is joined to the strip at the bottom by means of a piece of plywood at the leading edge. This plywood runs along the entire leading edge of the wing. It is joined to the ribs by nails and glue, and serves to hold the cloth covering taut over the wing.

There are many other types of rib construction. The most rigid rib is one in which the entire profile of the wing is cut from a single piece of plywood. Slots are then cut in the plywood to reduce the weight and to give room for the spars to pass through. Figure 116 is a diagram of this type of rib. A less expensive, but highly useful, rib is made by cutting the rim alone from plywood. This rim is braced by diagonals (see Fig. 117). All plywood rims should be reinforced by cap strips around the outer edges of the rims. But ribs of this sort are both expensive and difficult to build, and are usually used only in soarers.

Spars.—Solid spars are used in most training gliders, since they are the simplest to build. When solid spars are used, they are usually placed fairly near the leading edges of the wings, so that they will not need to be too thick and thus add excessive weight. Solid spars are not usually much larger than 3 or 4 inches by $\frac{1}{2}$ inch.

If you are building a high performance glider, solid spars are not suitable. Spars made to run through the thicker portions of the wing profile may be made in several ways. They may be made like iron girders, of two long thin strips running parallel, and joined by diagonal braces fastened with gussets, like the spar shown in Fig. 118. They may be of I-beam section, that is, made of a flat strip of plywood, stiffened by cap strips, as Fig. 119 shows. Or they may be hollow boxes built of plywood (see Fig. 120). But these spars are used especially to resist torsion, or to give additional strength, and are commonly used only in soarers.

Beside the regular spars, additional lengthwise reinforcing strips, made either of wood or thin strips of metal, are often used along the leading and trailing edges of the wing, and along that part of the wing to which the ailerons are to be hinged. These are not used if the edge is covered with plywood, as the leading edge often is; the trailing edge also may have plywood or a thin strip of metal, probably aluminum.

HOW TO BUILD A GLIDER

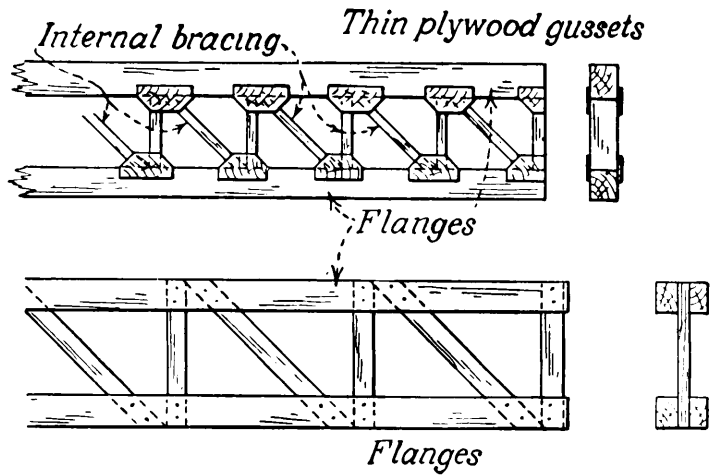

FIG. 118.—Two types of spar construction. These figures show both an elevation and a cross-section view of each type of spar.

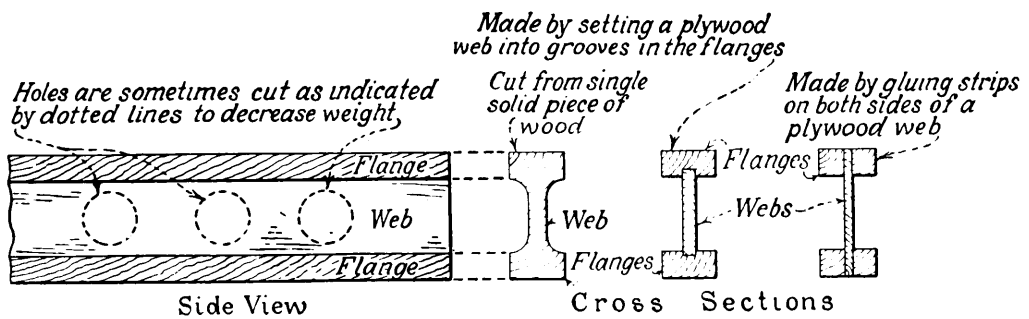

FIG. 119.—I-beam spar (three methods of construction). These are made of a section of plywood strengthened by cap strips at either edge.

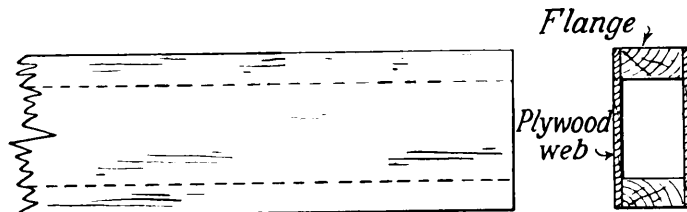
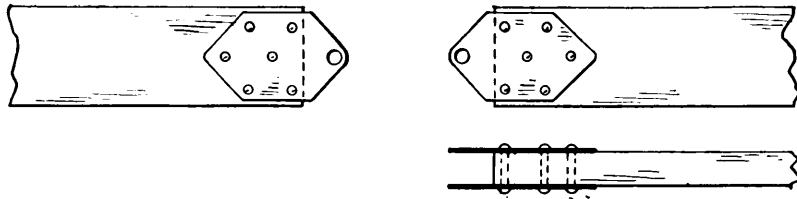

FIG. 120.—A box spar. This is a hollow box built of plywood. It is a uselessly expensive type of spar for fairly low-performance gliders.

GLIDING AND SOARING

The wings of primary training gliders are usually made in two units so that they may be easily taken apart, to be repaired, stored, or transported. The fittings for joining the spars in this case are shown in Fig. 121. These fittings should be attached to the spars before the wings are assembled. They are designed so as to allow the spars to be joined by easily removable pins.



Metal Fittings for Ends of Solid Spars Externally Braced

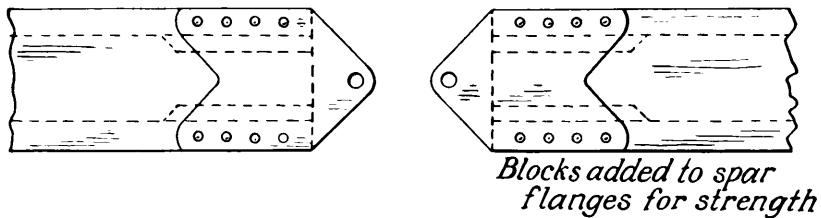

Fittings for Box Spars, Externally Braced

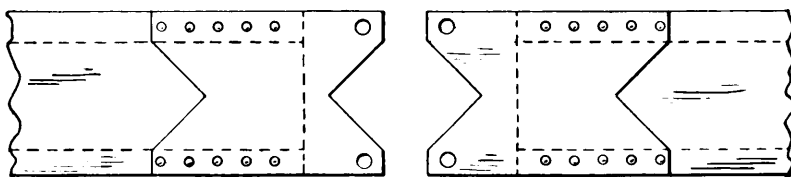

Fittings for Cantilever Spars

FIG. 121.—Some metal fittings for spars. Some primary training gliders are built with spars in two sections, so that they may be easily taken apart.

Assembling the Wings.—The usual method of assembling the wings is to set up the spars on trestles or on the floor in perfect alignment. The spars may be lined up by the use of a string. You should mark out with a pencil the point on the spars where each rib is to be located. The ribs are then fastened into place on the spars (see Fig. 122). Ribs are usually set about 1 foot to 18 inches apart. If they are farther apart than this, they will not serve to hold the wing covering in shape, especially over the nosing, and

HOW TO BUILD A GLIDER

false ribs, extending forward from the front spar, should be inserted between the true ribs (Fig. 123). Several ribs at the wing tips are occasionally made heavier than the others, to withhold the strain of the taut wing covering; in this

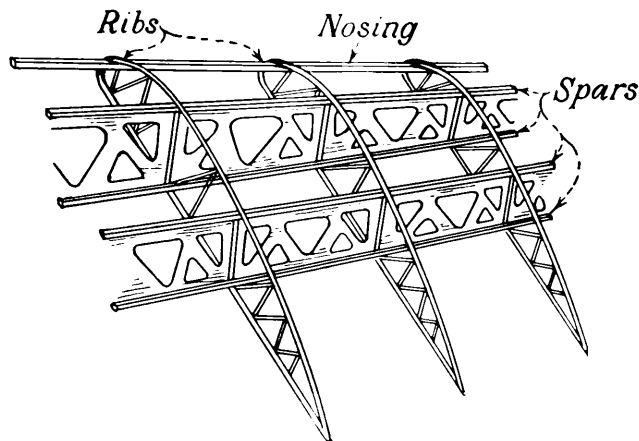

FIG. 122.—The wing assembled. The ribs must be placed close enough together so that they will hold the wing covering taut.

case, you should be sure to put these ribs in the proper positions. Glue and, if necessary, nail the ribs firmly to the spars. It is essential that the assembling should be done with great accuracy.

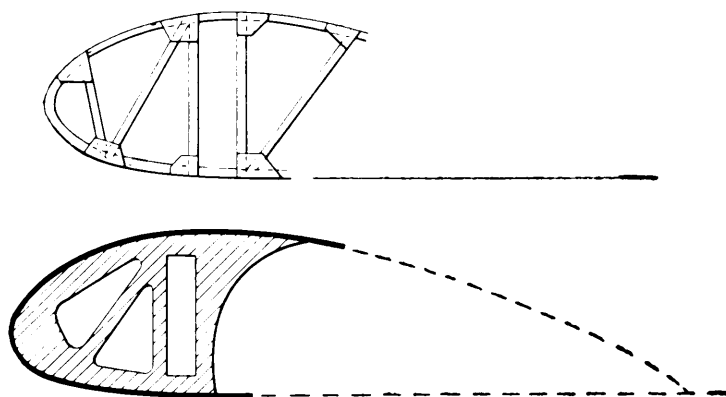

FIG. 123.—False ribs. These ribs are sometimes placed between the real ribs, in order that the wing covering may not sag between the ribs, destroying the streamlined shape of the wing.

Wire Bracing.—After the ribs are fastened in place, the whole structure must be braced with wires. The wires used to brace wings internally are called the “drift” and “anti-drift” wires, or cross bracing. These wires run diagonally

GLIDING AND SOARING

from the rear to the front spar. The drift wires serve to offset the tendency of drift to sweep back the wings; the anti-drift wires simply equalize the strain exerted by the drift wires on the wings. A possible arrangement of these wires is shown in Fig. 124. The wires are attached to the spars by means of metal fittings, which are illustrated in Fig. 125.

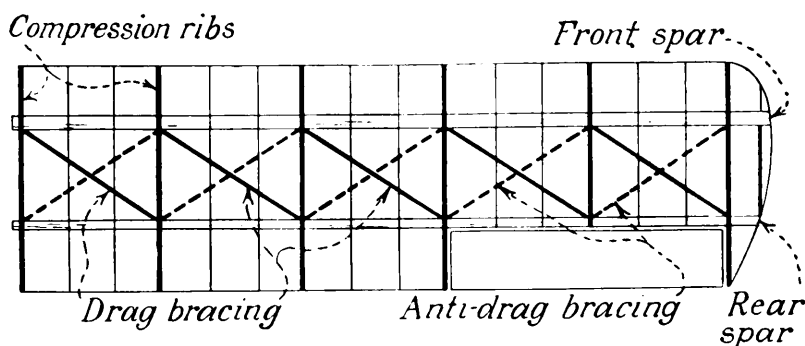

FIG. 124.—Method of arranging the internal bracing wires of the wing.

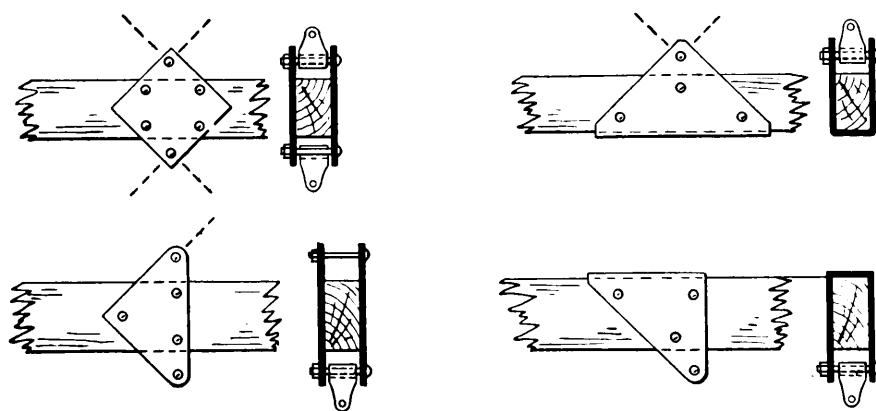

FIG. 125.—Some types of metal fittings for attaching wires to the spars. The wires are attached to these plates which are bolted to the spar.

The Fuselage and Landing Gear.—The fuselage of a primary training glider is comparatively simple to build, but there is at present a great deal of dissatisfaction with the type usually seen, which is an American adaptation of the German “Zoegling.” When starting to build you may, however, begin construction with the box skid. This should be made of very strong material, since it must withstand many landing shocks. Put together the top and the side

HOW TO BUILD A GLIDER

of this skid, and brace them with several diagonal strips of wood. The piece of wood forming the bottom of the skid should then be steamed and fastened to the skid (see Fig. 126).

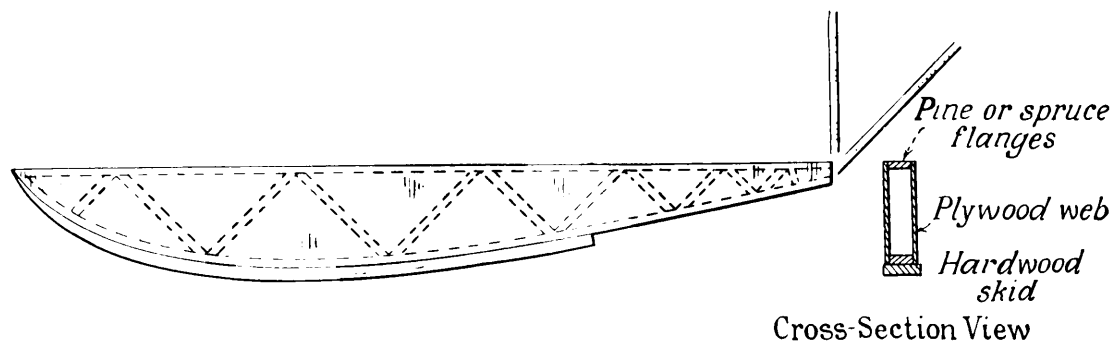

FIG. 126.—A completed box skid. The box itself is built like box spar. The skid is of hard wood, steamed, and bent into place.

The front posts in the fuselage, running from the skid to the wings, should be of strong wood, about 3 inches by 1 inch, and streamlined. The best plan is to run these struts right through to the base of the box skid. The frame-

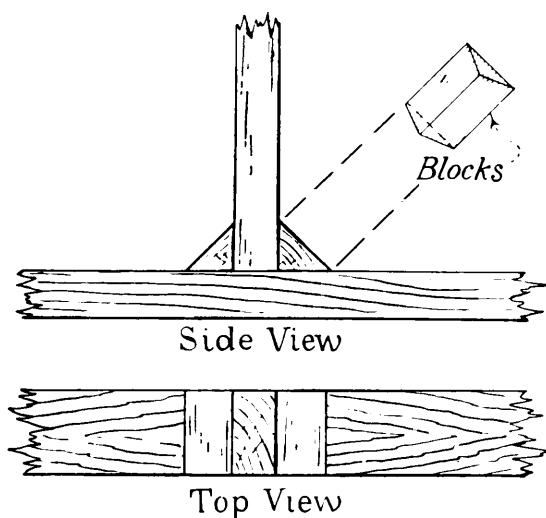

FIG. 127.—Blocks used to strengthen joints in the framework of the fuselage. These blocks should be glued, or glued and nailed, into place.

work of the fuselage which extends backward from the wings to support the tail group may be made of metal or of wood. This must be carefully lined up and the intersections laid out accurately. Fasten the joints firmly by insert-

GLIDING AND SOARING

ing three-cornered blocks into the angles of intersection (see Fig. 127) and by reinforcing with gussets.

Gliders of this type must be flown very carefully. There is little or no lateral strength to the fuselage, making it dangerous in a yaw while towing, and very breakable in a side-slip landing. The main vertical member, being of wood, sometimes shatters in a hard landing, releasing the safety belt, and throwing the pilot on his head. Steel tubing corrects this latter weakness but not the lateral as it would

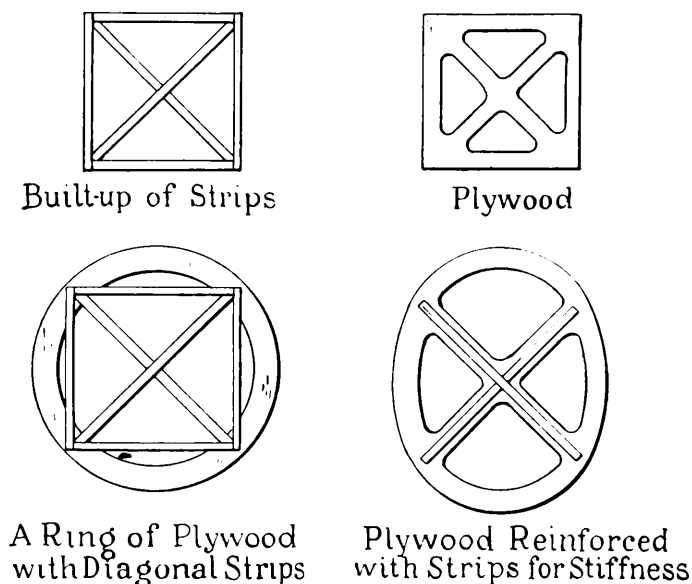

FIG. 128.—Some types of bulkheads used in an enclosed fuselage. These bulkheads serve to hold the longerons in place. They are sometimes removed after the entire fuselage is finished.

bend where the wood might break. A steel-tube keel with a V-shaped cross-section has been suggested to give lateral strength.

The enclosed fuselages of secondary training gliders and soarers are more difficult to construct. These are built in the manner of boats over a series of bulkheads or forms set thwartwise of the fuselage at stated intervals. It may be intended to remove the bulkheads after the longerons have been put in place. In this case, they may be made of almost any kind or thickness of wood. But some, if not all of the bulkheads commonly remain, in order to give the structure

HOW TO BUILD A GLIDER

great rigidity when it is completed. They are then built of plywood or of some other light material. Some typical bulkheads are shown in Fig. 128. If no bulkheads are allowed to remain in the completed fuselage, cross braces, similar to those used in rib construction, may be used to strengthen the fuselage.

The longerons, or lengthwise members of the fuselage structure, must be attached to the bulkheads, and all joints fastened as in the openwork fuselage. Another lengthwise member is often built into the fuselage, from one end to the other, like a backbone, to give strength. Do not depend upon wires to brace the fuselage, for they will not withstand severe landing shocks.

Steel tubing can be used to advantage and is less dangerous in a bad smash. While it will not break, however, injuring the pilot, it will bend and is difficult for amateurs to repair. For auto towing and aircraft towing steel should be used. Properly selected, it is no heavier than wood.

An enclosed fuselage is covered with plywood, cloth, or both. Plywood covering is expensive and somewhat difficult to build. A cloth covering, treated with dope, and strengthened in places with plywood, is the most satisfactory material for the amateur to use.

The seat consists of wooden bottom and a curved metal or wooden back.

The Undercarriage.—A single skid, or runner, is used on most gliders and soarers. Primary training gliders sometimes have such a runner in addition to the box skid; sometimes springs are put between the base and the runner. You should make this runner of clear, hard wood, ordinarily about 10 or 11 feet by 3 inches. The runner is bent into shape by steaming it; the curve should be sharp at the front and gradually decreasing, so that it is flat at the rear end, somewhat like a toboggan. It is important on a primary training glider that the runner be easily removable, since it may easily be broken and have to be replaced.

GLIDING AND SOARING

A tail skid is used on most gliders. This prevents damage to the tail group in landing. This is similar to the main runner, except that it is smaller and shorter. It is fastened below the tail end of the fuselage, at about the point where the tail controls are fastened.

Wheels are used on those gliders which are intended to be towed behind automobiles. The wheels should be small, hung close to the fuselage, and provided with shock absorbers, if possible. The simplest method is to buy the wheels. Probably the neatest use of the wheel is to have it "buried" in the skid at the normal point of contact with the ground. In a hard landing, the balloon tire lets the ship come down gradually on the skid, acting as a shock absorber. This wheel may have a brake for spot landings.

The Control Surfaces.—The control surfaces are, in general, built in the same way as the wings, except that they may be made of lighter material and they have no camber.

You must take care that the ailerons do not spoil the streamlined shape of the wings. The jig for the ailerons should be made from the full-sized drawing of the wing profile which you have already made. If the ailerons run the whole length of the wings, the simplest method is to make a separate jig for the ailerons. If, however, the ailerons only extend along the trailing edge of the wings a short distance from the tips, no new jig needs to be made for them. After all the ribs have been fastened to the spars, it is possible to saw off those rib tips which are to be used for ailerons. Small spars will previously have been put into position, to serve as the leading edges of the ailerons.

The ailerons are hinged directly to the main rear spar, or to a spar set in the wing purposely to carry them. Three methods of hinging ailerons are shown in Fig. 129.

Training gliders are usually built with triangular stabilizers and stationary fins. The elevators and rudder are hinged directly to these airfoils, much as the ailerons are

HOW TO BUILD A GLIDER

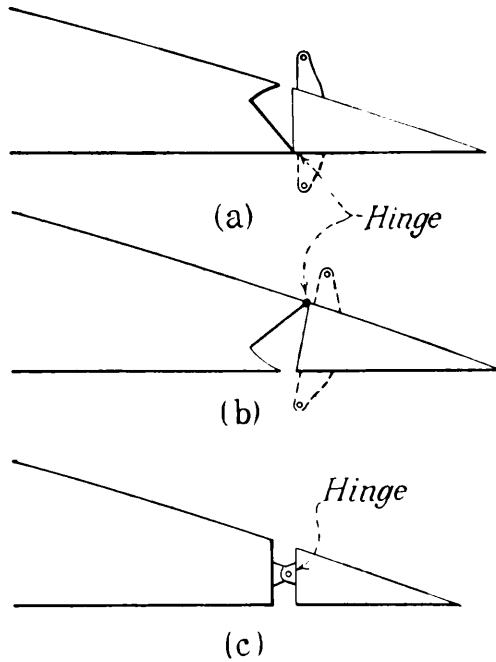

FIG. 129.—Methods of hinging ailerons. Methods (a) and (b) are more satisfactory than (c), since they add less to the parasite resistance; (c), however, is the most common.

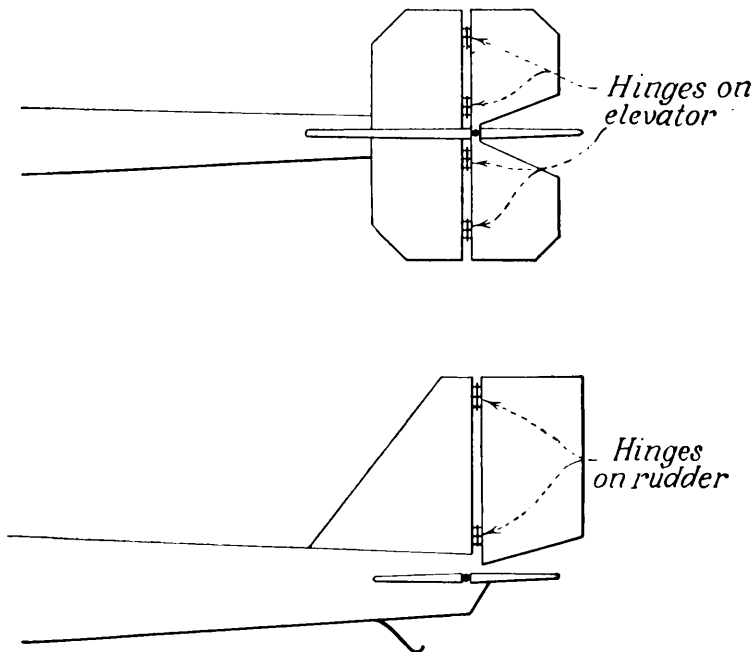

FIG. 130.—Method of hinging the elevators and rudder. The elevators are usually fastened to a stationary, horizontal airfoil, called a "stabilizer," and the rudder to a fixed vertical fin.

hinged to the wing (see Fig. 130). Soarers, on the other hand, often have elevators and rudder which are pivoted at the center of pressure.

Cloth Covering.—The wings, the control surfaces, and often the fuselage must be covered with cloth. The wing covering can in some cases be made up in the form of a properly shaped bag, to be pulled over the ribs and spars and nailed, glued, or sewed into place. This method of covering is not so satisfactory for most purposes as that by which the cloth is glued or sewed to all the ribs, and tacked along the edges of the wing. In this case, the cloth need not be made into a bag, but can be drawn over the wing in strips. A wing covering which is fastened securely to the wood structure greatly strengthens and stiffens the entire wing.

The strips of cloth used for the covering should be sewed together firmly, wherever necessary, with strong thread. It is well to cover the seams with tape. The tape may be made to adhere by means of glue or dope. When the cloth covering has been applied, it should be given several coats of dope. The dope will cause it to shrink until it fits tightly over the framework. There is some danger of stretching the cloth too much: the right degree of tautness may be determined by experiment.

Control Mechanism.—The stick and rudder bar should be set into the floor of the fuselage at a comfortable distance from the seat. The stick is usually of wood covered with a metal tube, so that bolts may be put through it without crushing the sides of the tube. The construction of the base of the control stick, from which wires run to the ailerons and elevators, is pictured in Fig. 131. The rudder bar is a piece of wood shaped like the rudder bar on a bob sled. It is pivoted at the center to a short post projecting from the floor. From holes in each end of it, wires run to horns affixed to the rudder.

HOW TO BUILD A GLIDER

The control surfaces themselves are fitted with horns, *i.e.*, small blocks of wood, with holes bored through them, projecting from the control surfaces. Through these holes in the horns, the other ends of the control wires are run

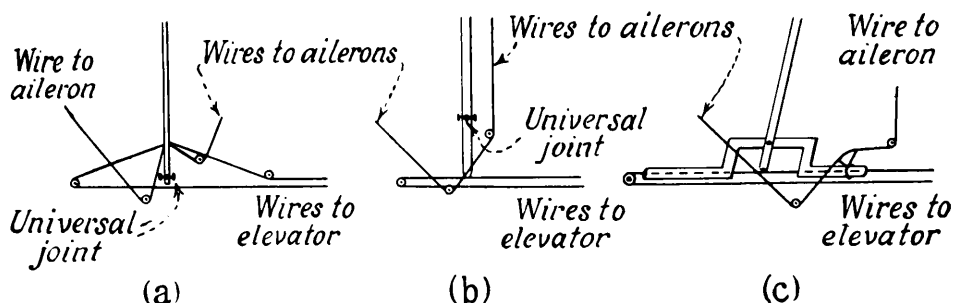

FIG. 131.—Some ways of attaching the control wires to the stick; (c) is the most common of these methods.

(see Fig. 132). The method of lining up these wires is described in the following chapter.

Struts and Wires.—The primary training glider has a considerable amount of trussing which is open to the air. The struts, *i.e.*, the pieces of wood or metal which brace the

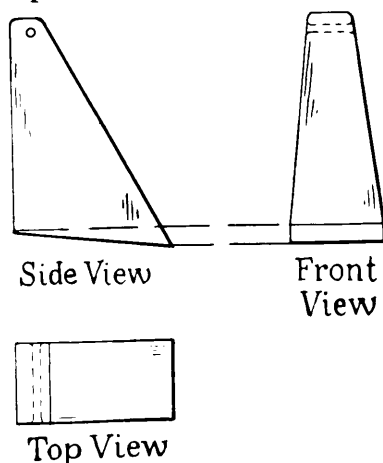

FIG. 132.—Three views of a horn. Horns are attached to the control surfaces, and the control wires run through a hole in them.

wings, are usually streamlined. It is customary to put ferrules, or other metal fittings, at each end, so that they may be held in place strongly, and be easily detachable.

A great many wires are used to brace the whole construction of a primary training glider. The most important

GLIDING AND SOARING

of these are the landing and the flying wires, which are shown in Fig. 133. Numerous other guy wires are used, such as those stretched from the tips of the stabilizer to the rudder post. The wooden framework of the wings, fuselage, and

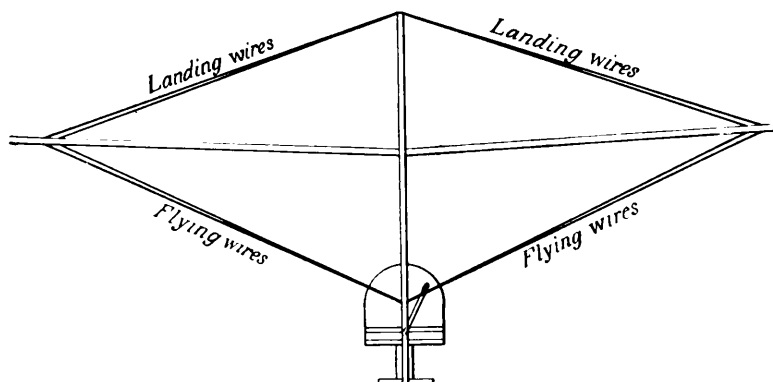

FIG. 133.—Landing and flying wires. This figure is a front view of a primary training glider, showing those wires which bear the strain of landing, and those which bear the strain of flying.

control surfaces is reinforced by gussets at the points where wires or struts are attached.

Wires used for trussing are fitted with turnbuckles so that their tension may be adjusted. Figure 134 shows a turnbuckle. It is necessary that the wires should be tight enough to serve their purpose, but loose enough to give slightly.

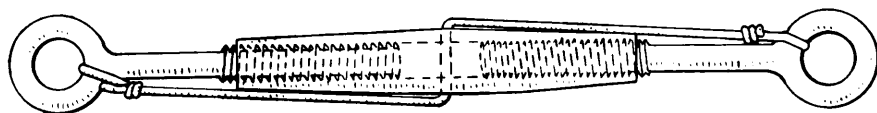

FIG. 134.—A turnbuckle. This is the appliance by which the tension of the wires is adjusted.

Secondary training gliders have fewer struts and wires, and are often semi-cantilever. Soarers are designed on the cantilever principle, so that they do not have any outside trussing of the wings.

Water-glider Construction.—The construction of water gliders is in some respects different from that of land gliders.

HOW TO BUILD A GLIDER

The float is covered with either duralumin or wood, or sometimes with wood covered with cloth. A metal float is difficult to shape and requires special tools. The wood used for floats is usually cedar or mahogany. Wide, clear, and amply long pieces of white or western red cedar can be obtained. Brass or copper tacks and nails should be used in the float to prevent rusting. A float is built in much the same way as the enclosed fuselage of a land glider. The wood covering must usually be steamed and bent into place around the bulkheads; the boards or "streaks" should be fastened as close together as possible. The cracks between them may be filled with glue or heavy varnish; but if the joints are accurate the water will swell the wood enough to close the crevices. If you should cover the float with cloth, more coats of dope should be given to it than to the fuselage covering of a land glider, since it is important that the float soak up as little water as possible.

The wing floats of a water glider are built in the same way as an entirely enclosed float. They must be large enough to have sufficient buoyancy, but small enough to increase parasite resistance as little as possible. The amphibian glider is one which will take off on land but land on the water. The National Glider Association states that the development of this type glider will make available three times the soaring terrain in America.

Conclusion.—Although a number of primary training gliders have been designed and the designs well treated, comparatively little experimenting as yet has been done in this country with gliders of a higher performance. When building your first gliders you will do well to work with these already tested designs. It will rarely happen that you start your building with an advanced ship, but it is particularly necessary that great care be given to the choice of design and the building of anything but a primary ship. It has been impossible here even to suggest the extent of such designs. The more construction work there is carried

GLIDING AND SOARING

on, however, the greater will be the advance in the science of glider design. When the amateur has built two or three planes, he will no longer be an amateur, but will, perhaps, be prepared to draw original plans and to test out new types of motorless planes.

CHAPTER XXIV

MAINTENANCE

A KNOWLEDGE of maintenance is of importance to any one who is either building or flying a glider. There are certain means for transporting the glider from the factory, and from one glider field to another. You should not only be able to effect some minor repairs, in case of accident, but you must also know the nearest place where the repairs can be made and new parts purchased.

Devices for Transporting the Glider.—When gliders are sent out by rail from factories, they are usually crated or boxed, with the wings and the fuselage packed in different units. There are, however, methods by which the glider can be transported after it has been assembled. The commonest of these is a trailer, *i.e.*, a frame mounted on wheels which can be fastened behind an automobile. The wings are removed and placed on this endways. Moreover, gliders are sometimes transported by a carriage, or frame, onto which the fuselage can be set, so that the wings protrude at either side. This carriage can be put onto a truck, allowing the glider to be moved without being jarred.

Attaching the Wings.—On most gliders, the wings are set at zero incidence (see Fig. 135). You can find the correct position for the wings by calculating, from the plans, actual distances between definite points on the wings and on the fuselage.

When you have set the wings in place, the struts must be attached. These will already be the correct lengths, if they have been made exactly in accordance with the plans. They

GLIDING AND SOARING

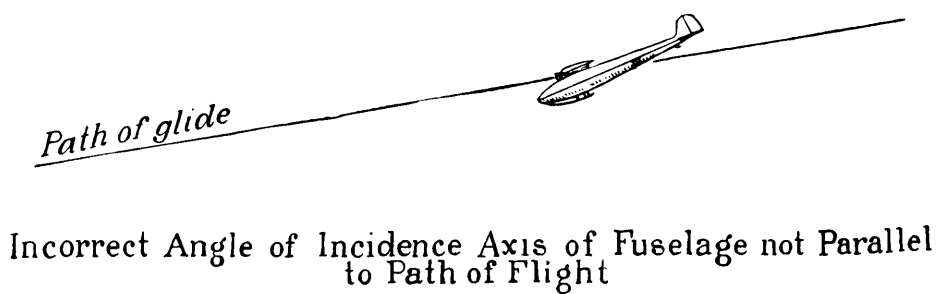
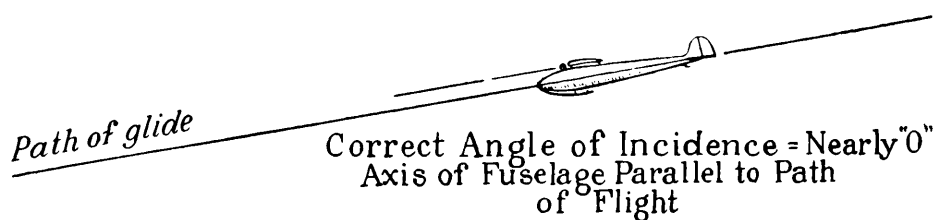

FIG. 135.

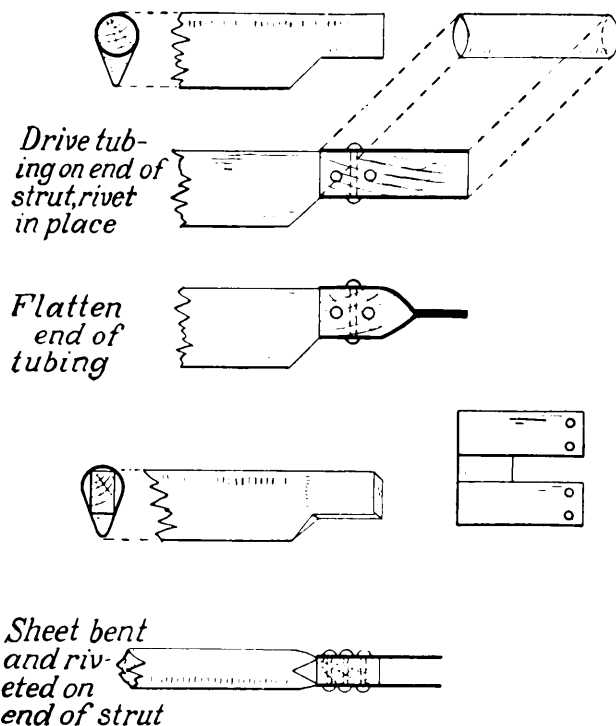

FIG. 136.—Strut and fittings. Examples of fittings which may be used for fastening the struts.

are fastened into place by means of metal fittings at either end (see Fig. 136).

Fastening the Guy Wires.—In all planes except those with cantilever wings, the wires have to be lined up. This is a very delicate piece of work, and must be done with great precision. After the wires are attached to the rest of the structure by means of special fittings, they must be tightened by turnbuckles until they have the proper tension. It is important that the tension of all the wires be practically equal, especially that of the flying and landing wires. If these wires have too much tension on one side of the wing, they will pull that side out of shape, and out of line; if they have too little tension, they will allow the wires on the other side of the wing to distort that side. You can judge this necessary equality of tension pretty nearly by plucking the wires to feel whether they all have the same tautness, and to hear whether they all have the same pitch. When you have completed the adjustment of the wires, you should fasten the turnbuckles by passing another wire through the hole in the center member of the turnbuckle and twisting its ends through the holes in its ends. All fittings should be safetied.

Attaching the Control Surfaces and Wires.—When the wings have been joined to the fuselage, the glider is practically complete except for the control system. The stabilizer and stationary vertical fin must be put into place. Fasten the stabilizer at zero angle of incidence, and the vertical fin perpendicular to it. (Use a carpenter's square to obtain exact right angles.) Then, hinge the ailerons, rudder, and elevators into their respective positions.

The system of control wires is shown in Fig. 137. The rudder wires run directly from the holes in each end of the rudder bar to the holes in the horns at either side of the rudder. The wires may be fastened by doubling the ends back and twisting them around the main wire where they

GLIDING AND SOARING

should be firmly bound, or by twisting the ends around bolts fixed on the horns for this purpose. This is an important operation and should be done with great care.

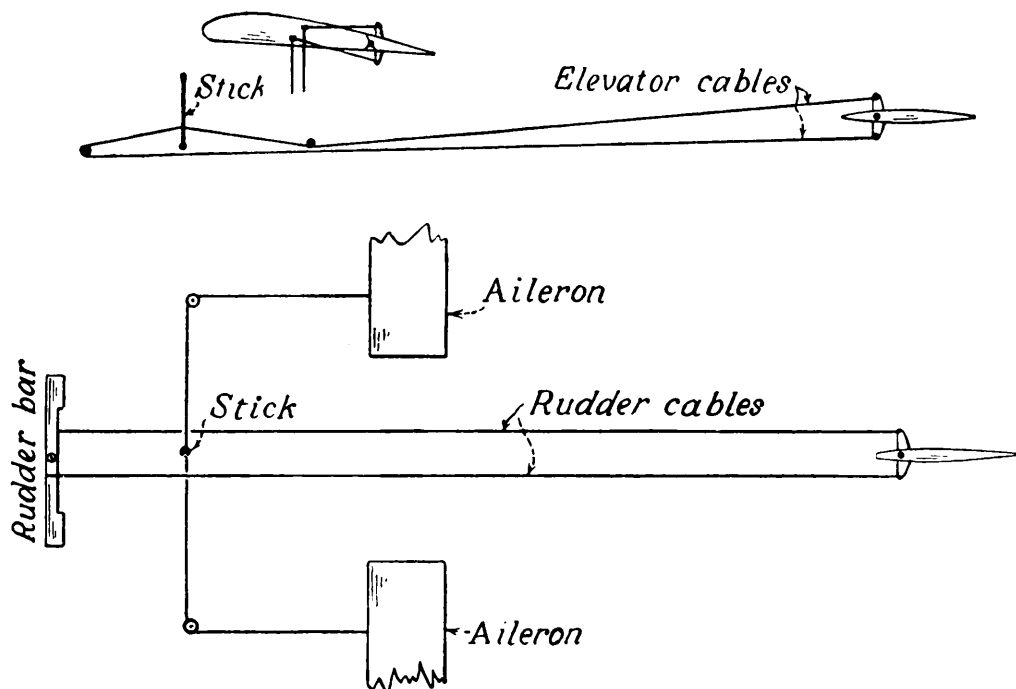

FIG. 137.—The system of control wires. This figure shows how the wires are run from the stick and rudder bar to the control surfaces.

There are two general methods of operating the ailerons. The simpler of these is that by which a spring is attached at one end to the under side of the wing and at the other

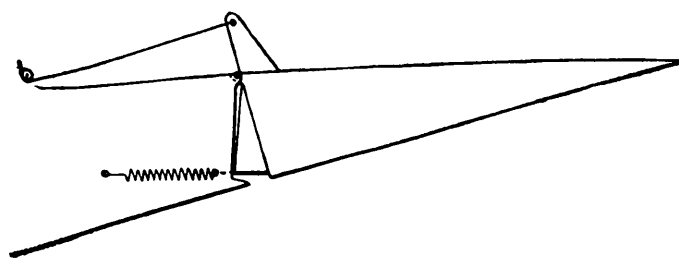

FIG. 138.—An easy method of actuating an aileron. The spring constantly tends to pull the aileron down.

end to the under side of the aileron. This spring tends constantly to pull down the aileron. When the wire, which runs from the horn on the upper side of the aileron to the stick, is not pulling the aileron up or holding it in normal position,

the spring pulls the aileron down (see Fig. 138). This system may be reversed and the spring attached to the upper side, thus pulling the aileron up. This type of aileron control may be used on a primary training glider although its use is questioned by many authorities, but it will not do for a more highly sensitive type of ship, since the spring is always apt to get caught or become weakened.

The other and better method of operating the ailerons is to run two wires to each aileron from the torque tube, over pulleys, or "sheaves," fastened to the main part of the wing just in front of the aileron horns, and through the horns which project, one from the top, and one from the under side of the aileron.

To each elevator, two wires run from the stick, over pulleys, and through the horns on the upper and lower sides of the elevator; these wires are crossed once between the pulleys and the horns. Be very sure that you do not confuse the different cables.

The control wires are fitted with turnbuckles, as are the guy wires, and these should be carefully adjusted. You must make sure that, when the stick and rudder bar are in neutral position, the ailerons and elevators are exactly in line with the wings and stabilizers, and that the rudder is in line with the vertical stationary fin.

Testing the Glider.—When the glider is assembled, when all the angles are as correct as they can be made by measuring and viewing them, and when all the wires have an approximately equal tension, the ship should be tested out in actual flight. Such tests are best made by an expert pilot.

Before taking off, the glider should be balanced on the skid on level ground, with the pilot in the cockpit. If the construction has been properly carried out, the ship should balance exactly on the center of pressure of the wing. Every standard airfoil has been tried out in wind tunnels and the center of pressure determined. The specifications published

by the National Advisory Committee for Aeronautics give figures for the enlargement of the various wing profiles, and show the position of the center of pressure of each wing.

You can determine the point on the fuselage on which the ship should balance by drawing a line perpendicular to the chord of the wing from the center of pressure. If the ship does not balance on this point in the fuselage, do not fly it until you have corrected the balance. This should be done by changing the position of the wings, or by some other means, and such changes should be made under the direction of an expert.

Launching for the test flights should be done by the shock-cord method. It would be dangerous to tow the ship into the air without knowing whether or not it is airworthy. When an able pilot has made several test flights in the glider, he can tell whether the wings are lined up properly, whether the control wires should be adjusted further, etc. Sometimes it may be necessary to change slightly the angle of incidence of the stabilizer. In this event, its angle may be varied by the insertion of a wooden wedge of the proper thickness.

Repairs.—As soon as you begin to use the glider, you must expect that it may at any time need repairs. The firmest glider structure is apt to be injured by the shock of a bad landing. Primary training gliders are usually built so that they can be readily taken apart, and the damaged parts replaced by new ones.

The best way to assure yourself of the use of a glider at any time is to have more than one so that you can fly one ship while the other is being repaired. For this reason, it is a good idea to begin to plan to build another ship as soon as you have experimented sufficiently with the first one to know exactly what type you want next and what improvements you want to make.

You can keep the glider in better shape, if you are able to effect a few minor repairs yourself. Therefore, you should

MAINTENANCE

keep a kit, containing the most useful tools, in an accessible place. A work bench in the hangar is convenient. Besides tools, you should also have a number of spare parts. If you have purchased the glider, these parts can usually be obtained from the manufacturer; if you have built your own ship, you should provide duplicates of several of the parts. The extra parts which you will probably have most need of are: an undercarriage (for a primary training glider, a whole box skid may be necessary), a starting hook, and, for the primary training glider, a rudder bar and seat. An extra shock cord may be used to lengthen the old one in order to launch accomplished pilots at a greater velocity.

A few minor parts may be replaced and small repairs made by any one who has built a ship. Slight breakages in wooden fuselages can be mended by cabinet-makers. But only an experienced aircraft builder will be able to tell whether a damaged wing can be repaired, or whether an entirely new wing must be used. Metal construction is very difficult to replace, and an injured metal wing or fuselage should, if practicable, be examined by the original builder of the ship.

Overhauling.—In addition to the inspection which the glider must be given before each flight, the ship should have periodic examinations by some competent person. The guy wires may relax after a period of hard usage, so that they no longer have sufficient tension. A few poor landings are apt to cause the glue at certain joints to crack; in this event, these joints must be reinforced, so that additional strain will not be transmitted to the remaining joints. Weakness of the joints will be made evident by the general looseness of the whole structure. An expert, upon inspection, is usually able to detect any such defects, and to prescribe the necessary reinforcements and alterations. Only in this way can the possibility of accidents be prevented.

GLIDING AND SOARING

Conclusion.—While continual reference is made to the expert with whom you should be in consultation, in time, of course, you will become experienced, at least to a certain degree, yourself. If you have worked over every part of the ship yourself in building it, you will certainly know how to make certain repairs. Experience and training, however, are essential for this.

PART SIX

EXPERIMENTATION

CHAPTER XXV. The Gliding of Motored Planes

CHAPTER XXVI. The Future of Gliding

Part Six is a discussion of the contributions which gliding may be expected to make in the future to aviation and other sciences.

Chapter XXV describes how motored planes may be made to soar or glide at intervals over the proper terrain in order to save the engine and the fuel, and possibly for other reasons. Chapter XXVI is a prediction of the ways in which the present glider may possibly be improved, and of the new purposes which gliders may be made to serve; this prediction is based upon the history of gliding, and upon the experiments which are now being made with gliders.

CHAPTER XXV

THE GLIDING OF MOTORED PLANES

THE gliding of motored planes is a science which offers many possibilities, although it has so far been little developed. Lieut. J. Thoret, a Frenchman, is said to have been one of the first pilots to make a very extended glide in a motored plane; he remained in the air with the motor shut off for more than 9 hours, and this in a plane of old-fashioned design. Following this accomplishment, a number of pilots all over the world have succeeded in imitating him.

Thoret was not the first pilot to glide a motored plane. Several Germans attempted it before him. The most notable of these was Botsch, who, in 1925, made a long flight on only about 2 gallons of gasoline; he did this by deliberately soaring his ship as much as possible. He won a prize for the least consumption of fuel, in competition with planes of all classes. His ship had a 14-horsepower engine.

But Lieutenant Thoret's gliding flight was the first one of great significance.

Importance of the Fact that Motored Planes Can Glide.—To be sure, Lieutenant Thoret's flight may seem to have taken away a good deal of the romance which had formerly been connected with soaring. The experiment proved that perfection of design is no more essential to soaring than are the strength and duration of the upward air currents and the skill and patience of the pilot; cumbersome, imperfectly streamlined airplanes and float seaplanes have been soared.

The fact that motored planes can be flown like gliders has a double significance to aviation. In the first place, an airplane which can glide efficiently has the advantages of

GLIDING AND SOARING

a glider which is fitted with an auxiliary engine, without its chief disadvantage: as long as the motored plane can glide wherever upward currents of sufficient strength are available, it can spare its engine and conserve its fuel; yet, unlike the soarer with an auxiliary engine, the airplane is adapted in construction and design for motored flight. Except if equipped with a self-starter, a pilot would only soar with a "dead stick" if within gliding distance of a

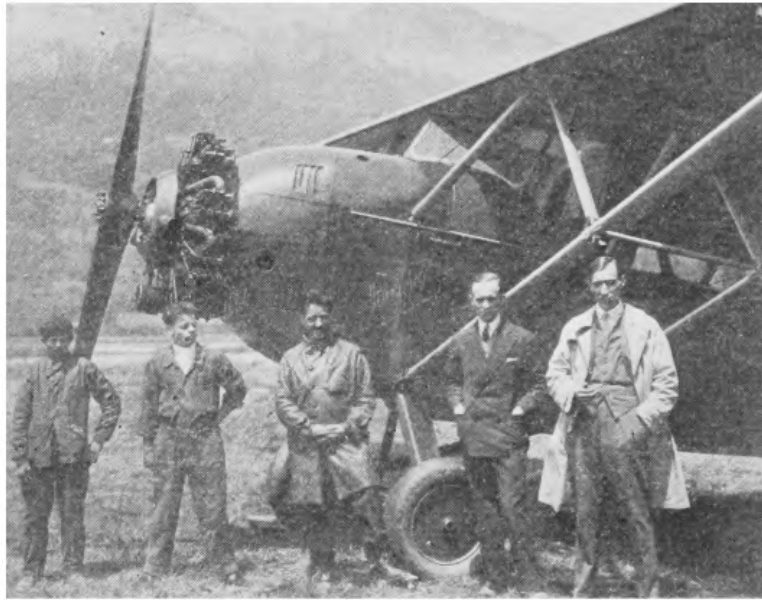

FIG. 139.—The transport plane in which Lieutenant Thoret is able to carry 10 or 12 passengers over the Alps by soaring. The fact that such a large, semi-cantilever ship can soar, proves that great power is supplied by some upward currents, and suggests infinite soaring potentialities of the light, perfectly streamlined soarer.

landing field. Still more significant is the fact that the proved ability to keep a ship aloft without use of the engine makes it possible to venture into some regions that provide no landing fields and thus are very dangerous for ships dependent on a possibly failing engine. By repeating experimental flights in a motored plane with the engine shut off, Lieutenant Thoret became so familiar with the varieties of air currents produced by the various configurations in the landscape, that he is now able to take a number of passengers at a time (see Fig. 139), over regions in the Alps which

THE GLIDING OF MOTORED PLANES

they would not otherwise be able to see. It is possible that clouds and storms may some day become as comparatively safe for motored planes as for gliders.

Advantages of the Light Airplane over the Glider.—Since it can be soared in the same way (although not so efficiently) as the glider, the light airplane has some advantages over its motorless parent. It is more solidly constructed, can take off under its own power, can gain height even where there are no upward currents, and is not obliged to land at whatever point the wind may leave it. But the light airplane is not a glider, and is, in most cases, not comparable with it.

How to Glide in a Motored Plane.—Of course, any plane will glide downward in still air; but the airplane's angle of glide is so steep that gliding in still air is of little value except as an approach for a landing. But any airplane can maintain a fixed altitude, if it is possible to find upward currents providing a lifting force equal to the airplane's sinking speed. Thus, your ability to soar in an airplane depends upon the strength of the upward currents over which it is flying, and its own angle of glide. The lighter the wing loading, and the more streamlined the design, the flatter will be the airplane's angle of glide. The stronger the prevailing wind, and the steeper and higher the mountains, the better will be the opportunities for soaring over any given region.

No one who is not skilled, both as an airplane and as a glider pilot, should attempt to glide a motored plane over rough terrain. Air currents in mountainous regions are apt to be treacherous, and infinite care and experimentation should precede any such effort. It is often impossible, while flying with the motor running, to detect upward currents. Therefore, it is best to choose a position where the upward currents are likely to be strong, to throttle down the motor, and to feel about until the wind gives the plane a noticeable

GLIDING AND SOARING

lift. Once the plane begins to soar, you should hold it to its normal angle of glide, and maneuver just as if you were soaring a glider.

The Gliding of Motored Planes as a Postgraduate Course.—The French government has already started a school, under the direction of Lieutenant Thoret, which teaches licensed army pilots how to glide motored planes (see Fig. 140).



FIG. 140.—The plane in which Lieutenant Thoret gives advanced instruction to graduate pilots. By learning to glide motored planes, pilots will become able to shut off their engines wherever upward currents are strong enough, and to travel over regions formerly considered dangerous.

This is an important new use of the principles of gliding, and illustrates the way in which the advances made in gliding may contribute to the science of aviation. As the gliding of motored planes is further developed, it is probable that more and more pilots will realize new possibilities for its application.

Conclusion.—The gliding of motored planes is a development of great moment. It is, however, still in an experimental stage, and has been attempted by comparatively few people and in only a few places. Thus, although it is dangerous for unskilled flyers, it offers a competent pilot excellent opportunities for research.

CHAPTER XXVI

THE FUTURE OF GLIDING

THE future of the glider movement will undoubtedly do much toward increasing air-mindedness of the American public, according to many leaders of aviation who were consulted. As one manufacturer expressed it, the glider will be to aviation what the crystal set was to radio. It will permit the youth of the country to experiment with this new activity at low cost and will stimulate a rate of development which would have been impossible by any other means. The vogue of the glider will result in better vehicles of the air.

The progress which has been made in soaring flight and in glider construction during the last decade is probably indicative of the great advances which gliding will make in the future. No one can predict what flight secrets will be disclosed to the glider pilot nor to what extraordinary ends the principles of gliding will be applied. Nevertheless, some of the glider's potentialities are already apparent.

How Gliders May Be Improved.—The glider's chief shortcoming at present is its uncertainty of propulsive power. A pilot cannot set out in a glider from one city to go to another; he must travel wherever rising currents of air are available. He will not cover much distance unless he is both skillful and fortunate. There are several ways in which gliders may possibly be improved to offset this drawback.

Auxiliary Engines.—In the first place, it is possible to equip gliders with light engines. Numerous experiments in this line have been successfully carried out. The engine

GLIDING AND SOARING

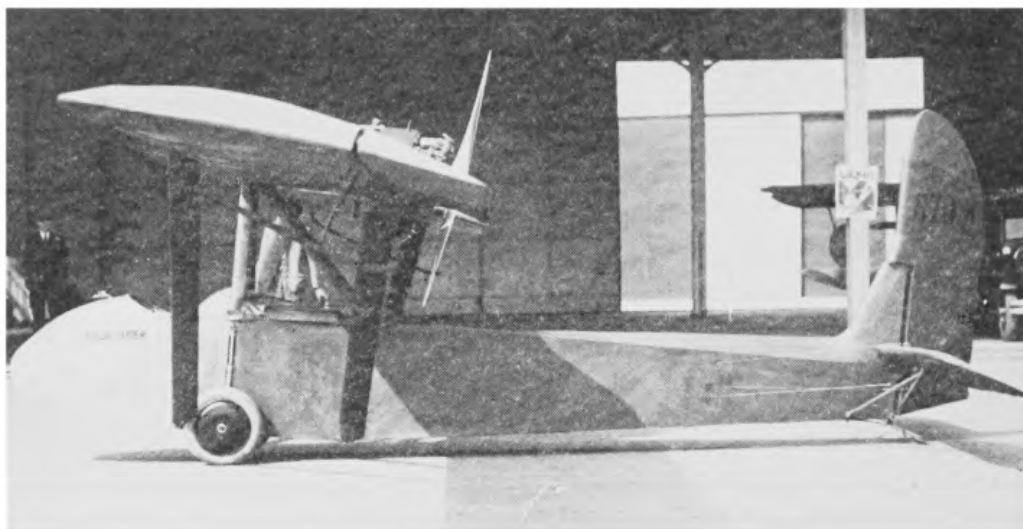

FIG. 141.—A glider with an auxiliary engine. This ship is designed to provide the student with a transitional step between gliding and flying in a high-powered plane. This ship has excellent visibility and a fairly efficient gliding angle.

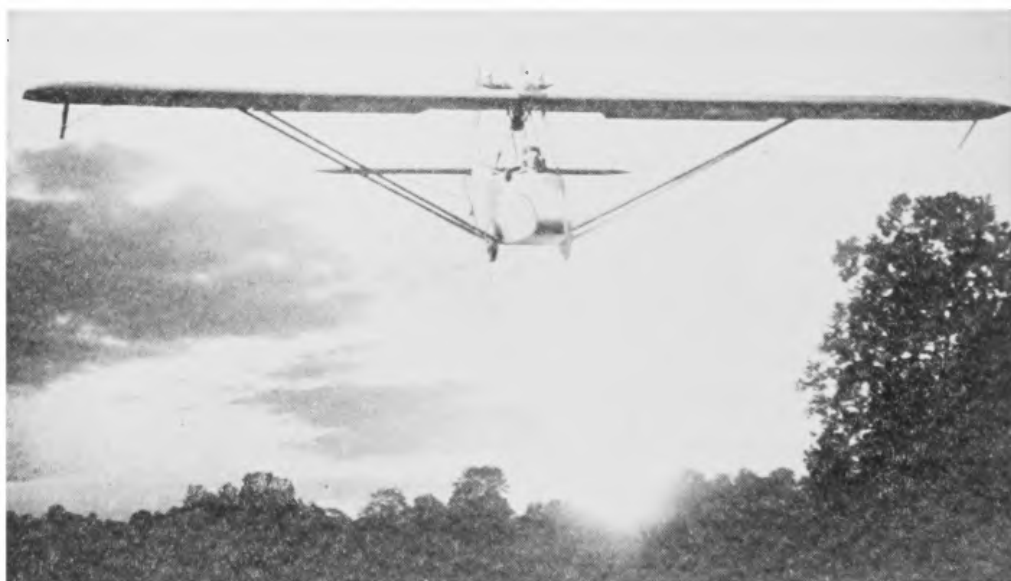

FIG. 142.—A motor glider in flight. The controls are built large enough to provide ample controllability at low speed, but not so large as to be too sensitive when the throttle is open.

THE FUTURE OF GLIDING

must be used to gain altitude only when there are no upward currents; the pilot "cuts the gun" and soars as soon as he reaches a good soaring terrain. Such engines must, of course, be light in weight. Although they are often built with only one cylinder, they have occasionally enabled gliders to attain speeds of 40 or 50 miles an hour.

Such motors should only be installed in advanced ships with the approval of the Department of Commerce and for the use of experienced pilots (see Figs. 141 and 142).

Although even a light engine increases the ship's weight, the glider with an auxiliary engine has advantages over an airplane, owing to the glider's light wing loading. Many motored gliders use a skid instead of wheels, to keep the weight low, and are launched by rubber shock cords. Although the structure of a glider must be reinforced when an engine is added, this strengthening does not necessarily add greatly to the weight. A powered glider lands exactly like one without a motor which means that the only increase in landing speed is that due to the small additional weight of the motor. Such speed is very much less than a regular motored ship. The chief value is that as soon as a glider has attained some altitude, and found the proper air currents, it can then glide for long distances without power.

In spite of the interest taken in gliders with auxiliary engines, however, Dr. Georgii, a renowned German authority, stated recently that motored gliders were "unsatisfactory both as gliders and as power airplanes" and that this line of development, except for special purposes, has been given up by the German Association for Soaring Flight. Most glider enthusiasts agree with him. Robert B. Evans, president of the National Glider Association, says that, although light motors are comparatively safe, it is unwise to install them, since people soon begin to want heavier ones.

On the other hand, Glenn Curtiss, who has had long years of glider experience, has said:

The best way, in my opinion, to learn to fly a glider is to put a motor in it.

GLIDING AND SOARING

In the early days of my interest in aviation, I considered work with gliders as pretty much a waste of time. My idea of the best way to learn to fly was to use the motor with a screw propeller attached direct to the engine shaft in whatever type of flying machine we wished to try out, and run, preferably, over the ice, but if the ice was not available, on wheels on a smooth road or parade grounds. This is the way we did learn to fly. I am now confident this plan was sound. We experimented with gliders but learned little about flight.

Today, flight is pretty well understood and many people know how to fly and have good machines in which to fly. Gliding is desirable as a sport and recreation. The equipment is, of course, comparatively inexpensive, but light inexpensive motors will soon be available and the glider will become a motor glider.

The future of this controversial subject is yet to be revealed. The consensus of opinion among the men consulted is summed up by one official, who says,

At the present time it looks as though the power glider will follow within the very near future. Straight gliding is not going to satisfy the present non-flyer very long. He will want to stay up longer than just a few moments. Since we feel this is the case, we are preparing to bring out a glider to which can be attached at a later date, if desired, an 8- or 10-horsepower engine which is being developed for us. The glider itself will sell for around \$500. and the engine as a separate unit for \$150. When the buyer is tired of his glider and wants to stay up longer than usual, and go places, he can buy this little engine, put it on his glider, and make 45 to 50 miles an hour across country.

According to the president of another company,

There is at present a missing link in aviation between the 10-mile-an-hour glider and the 40-mile-an-hour airplane. The glider with a small motor will fill this gap. It will have dual controls and will carry two persons, seated side by side. My company is placing such a plane on the market.

After having learned to fly the glider, the student pilot will seat himself in the power glider beside an airplane pilot. Together they will hop around until the student has had an hour or so of power flight. Then he will solo, and thereafter fly alone to build up experience.

Having accustomed himself to wings in his previous experience at flying the glider without power, the student pilot has no

THE FUTURE OF GLIDING

difficulty with his new vehicle. The motor merely takes the place of the shock cord in towing or launching. Should the motor go dead, he is not terrorized or helpless. He is in the same position as when the cord was released. He instinctively picks out a place to set down.

Thousands of clubs now flying gliders, with an investment per member of about \$25. will tire of just hopping up and down. They will want power on their wings. They will be found flying about behind a little putt-putt motor which costs them about \$50 per member. Fuel costs will be so low as to be almost negligible; 50 to 65 cents per hour. Depreciation costs will be small because of the low investment.

To the student pilot who has flown the glider with and without power, the step to flying the real airplane is now short and easy.

Rocket Planes.—Rockets, as well as internal combustion engines, may be used at some future time, to give the glider altitude over regions where there are no upward currents. Although some tests have been made of rocket planes, they are still wholly experimental.

A rocket plane is propelled by a series of rapid explosions which act upon it somewhat as a rifle shot does on a bullet. The rockets are usually arranged behind the pilot's cockpit, below the wings. A ship equipped with rockets might be enabled to take off under its own power, although this is not yet practical, or may be launched into the air before the rockets go off.

A plane which flies under the power of continually exploding rockets might become, in time, superior to an airplane with a gasoline engine. It has possibilities of greater speed, and also (unlike an airplane with a propeller) it becomes increasingly effective as the air becomes less dense. At present, however, planes cannot carry enough powder (or other "fuel") to enable them to make long flights by means of rockets; designers have not yet learned how to avail themselves of the greater part of the power created by the explosions. A ship which is propelled by continually exploding rockets is, of course, not a glider, but a power plane.

GLIDING AND SOARING



FIG. 143.—A glider used as an auxiliary to a dirigible. This glider is attached under the Zeppelin, and can be released at any time by the pilot, Barnaby.



FIG. 144.—Another view of Barnaby's glider. Barnaby contributed greatly to the usefulness of the glider by making a successful descent from this dirigible.

THE FUTURE OF GLIDING

New Uses to Which Gliders May Be Put.—Besides the possibilities of improving glider construction and design, there are, without doubt, numerous new purposes which the present glider may serve. The ideal status of the glider, and the one to which most aeronauts aspire, is that in which the glider may go wherever its pilot pleases, by making use of all kinds of wind currents. But, at present, this end seems unattainable without the application of power, although many successful distance flights with return to the starting point have been accomplished under suitable weather conditions. It is comparable to a sailboat in many respects, although operating under even less controllable conditions. The sail boat can sit still and wait for the wind to freshen; the glider cannot. Power, therefore, may need to be applied to make the glider utilitarian in the future, but it is possible that utility will not remain the chief objective.

Gliders as Auxiliaries to Dirigibles.—Gliders might conceivably be useful in carrying mail and passengers from dirigibles to the ground, to ocean liners, or to other dirigibles. The advantages of an easy method of descent from a dirigible in numerous instances are obvious. The glider is better adapted than the airplane to be used in this way since it is lighter and requires no fuel. Experiments of this kind have been conducted by the U. S. Navy very successfully (see Figs. 143 and 144).

Gliders as Lifeboats.—It is often suggested that gliders might be used instead of parachutes as “lifeboats.” Parachutes have the marked disadvantage of being practically uncontrollable in the air, so that the parachute jumper must land wherever he may. It is conceivable though hardly likely, that gliders could be carried in large transport planes, as well as in dirigibles. Yet, there are two apparently insuperable objections to this plan of using gliders as “lifeboats.” In the first place, gliders are several

GLIDING AND SOARING

times as heavy as parachutes, and could carry two passengers at the most. Second, it would take a few minutes to send the glider into the air, and when an airship is about to crash there is seldom time to make elaborate preparations for escape. Moreover, passengers with no flight training would be unable to use them.

Trains of Gliders.—Some successful attempts have already been made in towing one or two gliders behind a powered plane. Captain Hawks succeeded in flying from coast to coast of the United States in the tow of an airplane. It may even be practicable to draw whole trains of gliders, as a locomotive pulls its cars. The advantage of such a system would be that the gliders could be arranged in such an order that the last glider in line would be the first to cut loose from the train, and so on, until the first glider in the string reached its point of destination. The towed ships are called "trailers," and should be of the same rugged construction as the powered plane. Biplane gliders have been used as trailers in Germany, as have the great steel-tube monoplanes of the Franklin Brothers in America.

Powered planes may also tow gliders into the zone of the upwinds of mountains where there is no take-off point available owing to trees or rough terrain, and into the upwinds of clouds, for soaring.

Other Possible Uses for Gliders.—There are several military uses to which gliders might be put. Small gliders, released from the tow of an airplane, have already been used as targets for anti-aircraft guns. Gliders might be dropped from airships to battleships to carry messages, maps, etc. Officers, also, might be transferred from aircraft by means of gliders.

Contributions of Gliding to the Science of Wind Currents.—The future of gliding lies in the contributions which it

THE FUTURE OF GLIDING

can make to other sciences, as well as in the improvements and new uses which may be found for the glider itself. Since soarers are extremely sensitive to currents of air, they provide the best possible means of discovering the effectiveness of vertical, and possibly of horizontal gusts of wind, how gliders can avail themselves of clouds, etc. Many of the advances made in this field of meteorology have been made by students of soaring.

A knowledge of the way to recognize wind currents before they are gone is as necessary to the pilot as is a knowledge of the wind currents themselves. Soarers might accordingly be equipped with antennae, which would indicate the state of the air ahead. The antennae might consist of a pole, perhaps 10 feet in length, projecting from the nose of the ship, with a wind vane or "feeler" at its end. Such an indicator would allow the pilot to make greater use of approaching wind currents than he is now able to do. Experiments in this direction have already been made; but they have so far been unsuccessful, since they do not notify the pilot sufficiently ahead of time.

Contributions of Gliding to Aerodynamics and to Airplane Design.—Because gliders are light and comparatively inexpensive, because their speed is low and they are not subjected to vibration and the shocks of landing, it is safer to make experiments with them than with high-powered airplanes. Gliders have already greatly quickened the progress of aerodynamics and of airplane design, and they bid fair to make still greater contributions to these sciences.

For example, a good many attempts have been made to eliminate ailerons from gliders, although no very practical substitute has yet been found for them. Ailerons are an imperfect form of control, at best. They destroy the streamline shape of the wings when they are raised or lowered; and when they are in neutral position, there is a gap between them and the wing. Consequently, numerous

GLIDING AND SOARING

gliders have been built with flexible wings, warpable wings, or wings the angle of incidence of which can be changed.

The Future of Gliding in America.—Even before the glider has been improved or adapted to new purposes, it will, doubtless, become more and more widely used in America as a sport and as a means of flight training. The proof of this prediction is already suggested by the growing number of glider clubs and of airplane schools which are beginning to use gliding as the initial step in flight instruction.

Moreover, glider training is useful as a means of administering aeronautical education. Unless the youth of America is taught the principles of aviation, this country will lag behind many other nations in flight ability and in invention.

The popularity of gliding in this country has heretofore come and gone in quick flares; possibly glider enthusiasm may continue to die out sporadically (although there is at present no evidence of such a decrease), until the motorless plane has been adapted to more practical uses than at present. Nevertheless, the potentialities of gliding are numerous. As soon as these latent possibilities are developed into realities, the vogue of gliding will become continuous. There must be some foundation for the prophecies of such men as Colonel Lindbergh, who said, "Gliding activity will bring a substantial advance in the importance of aviation."

In a survey which we have made of the attitude of prominent officers of the aviation industry throughout the country, the opinion is strongly held that the glider is going to have a definite and a favorable effect upon aviation at large. F. B. Collins, of the Boeing Airplane Company of Seattle, Washington, says that the effect of gliders on the aviation industry should be beneficial, since the sport of gliding will, without doubt, serve to play a prominent part in promoting the air-mindedness of the general public.

THE FUTURE OF GLIDING

Gliders, through their low cost of construction and consequent low price, may not prove a source of great revenue to manufacturers, but they will be a means toward the end of creating powered airplane sales. H. Newton Whittelsey, of the Whittelsey Manufacturing Company, of Bridgeport, Connecticut, says: "I believe the effect, whatever its amount, will be beneficial to the aviation industry, if the manufacturers are careful to make only good gliders, and to guard their use to prevent serious accidents."

According to one of the Waco executives, gliders are going to be the salvation of the aviation industry. "We think," he says, "they will greatly increase the sale of airplanes. We consider them such a contribution to aviation that we are going into the manufacture of them."

G. R. Coats, of the Berliner-Joyce Aircraft Corporation of Baltimore, Maryland, says: "There is no doubt that a glider at a few hundred dollars' cost is going to enable many to get in the air who would be unable to do so otherwise. In other words, flying adds a new dimension to life, and it seems that we are all seeking new dimensions."

Edward D. Stinson, president of the Stinson Aircraft Corporation of Detroit, Michigan, says, "I believe gliding, properly supervised, will do more to assist aviation than anything I know of."

Conclusion.—The public must be educated to the essential safety of flight. Gliding will be an important means of teaching how all flight may be made safer. It will also serve as the instrument for carrying out such an educational program.

The glider is the greatest scientific pastime ever known. It is the inspiration of some of the world's best minds. Just as in the past it has made possible some of the world's most wonderful accomplishments and discoveries, so also in the future will it bear the American spirit of invention to greater heights.

INDEX

A

Aerodynamics, 68, 225
Age, 37
Aileron, 15, 33, 75, 196
 hinges, 197
 spring actuated, 206
Air pressure, 120
Airfoil, 69
Airplane, light, 215
 towing gliders, 86
 transport, 67
Alexander, J. Don, 5
Alterations, 209
Aluminum, 171, 188
 powder, 179
American Sailplane Co., 172
Amphibians, 129
Angle of attack, 22
 of glide, 94
 efficient, 94
 flat, 94
 normal, 149
Anne Lindbergh Glider club, 37
Antennae, 225
Archytas, of Tarentum, 26
Atmospheric pressure, 43
Attaching control surfaces, 205
Attaching wings, 203
Attaching wires, 205
Attack, angle of, 71
Axes of glider, 74

B

Balance, correct, 208
 of glider, 207
Balsa, 171
Bank, 115
 in turn, 114
Banking, 15

Barnaby, Lieut. R. S., 8, 222
Barometer, 44
 how to make, 44
Beginners, 82
 over-control, 96
Belt, safety, 17
Berlin Women's Club, 37
Berliner Joyce Co., 227
Bicycle, 114
Biplanes, 15, 62
Birds as gliders, 143
 how they soar, 140
 motive power, 140
 as soarers, 143
Boats, winged, 124
Boeing Airplane Co., 226
Bolts, 178
Botsch, 213
Bowlus, William H., 4, 164
Bowlus soarer, 60
Box kite, how to build, 54
Bulkheads, types of, 194
 typical, 195
Bumps, 96

C

Cautions to motor pilots, 100
 to power-plane pilots, 121
Cayley, Sir George, 26
Chanute, 29
Chord, 71
Climb, 22, 93
Clothing for long flights, 160
Cloud combinations, 51
Cloud formation, 47
Clouds, cirrus, 48
 cumulus, 48, 136
 nimbus, 51
 stratus, 51
Clubs, 11, 221
 glider, 226

GLIDING AND SOARING

- Coats, G. R., 227
Cockpits, 14
Collins, F. B., 226
Compass, reading, 160
Component, vertical, 146
Concentration, 39
Construction, 168
 water glider, 200
Control, aileron, 207
 loss of, 121
 mechanism, 198
 methods of, 61
 surfaces, 196
 systems of, 62
 tail, 61, 64
 wing, 61
 wires, 205
 system of, 206
Controls, 14, 64, 74
 birds, 141
 how they work, 74
 neutralizing, 116
 sensitivity of, 78
 straight flight, 96
 use of, 78
Convection, 135
Courage and confidence, 39
Course, keeping straight, 92
Covering, cloth, wing, 195, 198
Crabbing, 97
Crew, ground, 89
Currents, air, 215
 due to terrain, 134
 how to use, 148
 thermal, 135, 146
 treacherous, 148
 upward, 7, 133, 137
 where found, 133
 usefulness of various, 137
 wind, 223
Curtiss, Glenn H., 16, 30, 130, 219
- D
- Daedalus, 26
Damage, 209
Darkness, 164
Da Vinci, Leonardo, 26
- Dead stick, 214
Department of Commerce, 219
Design, choice of, 179, 201
Dew point, 47
Dinort, 161, 164
Dirigible, 222
Dives, 22
Diving, and climbing, 149
Dope, 64, 122, 178
Drag, 70
Drawings, 180
Drift, 98
Dual instruction, 18
Duralumin, 64, 122
- E
- Edges, leading and trailing, 188
Efficiency, wings, 70
Elevators, 15, 75
Engines, auxiliary, 214, 217
Equipment, for building, 176
Escalator, 146
Evans, R. B., 219
Expense, 182
Experience, 210
Experimenting with controls on ground,
 13
- F
- Fatigue, 161
Feathers, bird's, action of, 142
Feel, 14
 of plane, 94
Feeler, 225
Figure 8's, 163
Fin, 196
First flight, 17
Fittings, metal, 173
Flight, duration, 23, 163, 164
 experimental, 214
 extended, 94
 first, 93
 long distance, 23, 163
 path of, 96
 straight, 19, 92
 things to remember, 100
 water glider, 126

INDEX

- Float, metal, 201
 wing, 201
 Flying, winter, 66
 Franklin Brothers, 224
 Fuselage, 14, 64, 192
 enclosed, 194
- G**
- Georgii, Dr., 219
 German Association for Soaring Flight,
 219
 Gliders, advantages of, 3
 appearance, 59
 biplane, 224
 cabin, 160
 carrying, 112
 classic examples, 25
 construction, 175
 development, 1903 to 1920, 33
 since the war, 34
 hang, 17, 61
 how to build, 183
 how improved, 217
 as kites, 98
 as lifeboat, 223
 other possible uses, 224
 parts of, 13, 64
 pontoon, water, 123
 potentialities of, 7
 secondary, 94
 secondary training, 63, 179
 and soarers, 15
 as tenders to dirigibles, 223
 in tow, 119
 towing, 224
 types of, 59
 water, 17, 63, 122, 130
 Curtiss, 125
 Zoegling, 192
- Gliding, 17
 contributions of, 224
 to aerodynamics, 225
 future of, 217
 of motored planes, 213, 216
 at night, 162, 164
 as sport, 4
 as training, 5
- Gliding boats, 122, 123
 Glue, 177
 casein, 177
 Goggles, 18
 Ground-force, 162
 Gulls, 143
 Gussets, junction, 186
 Gustiness, 138
- H**
- Hangars, 12
 Hawks, 224
 Head covering, pilot's, 161
 Hearing, 38
 Hentzen, 34
 Horns, 199
 Humidity, 47
- I**
- Incidence, 70
 angle of stabilizer, 205, 208
 Indicator, air speed, 159
 bank, 159
 Inertia, 69
 Inspection, 209
 Inspector, 183
 Instruction ground, 41
 Instructors, club, 12
 Instruments, 164
 navigational, 160
 Irregularities of terrain, 137
- J**
- Jig, rib, 185
 Judgment, 38
- K**
- Kinetic energy, 149
 Kites, 54
 how to fly, 57
 points to remember in building, 54
 string, 56
 what they teach about gliding, 57
 Klemperer, 66

GLIDING AND SOARING

Knowledge, preliminary, 12
Kronfeld, Robert, 34, 88

Mouillard, 28
Mushy, 78

L

Lacquer, 179
Landing, birds, 142
 methods of, 21
 shocks, 195
 things to remember, 111
 water glider, 126
Landing gear, 65, 192
Landing places, 161
Launching, 208
 models, 173
Leaving ground, 88
Le Bris, 26
Leeway, 98
License requirements, 40
Lift, 68, 70
Light airplane, as glider, 215
Lights, auto, 164
 parachute flare, 165
Lilienthal, Otto, 25, 28, 140
Lindbergh, 9
Locations, suitable for soaring, 146
Longerons, 195
Loss of control, 96
Lumber, 176

M

Maintenance, 203
Map, study of, 161
Members, club, 12
Metal, construction, 209
Meteorology, 225
Meter, yaw, 159
Models, building, 169
 flying, 170
 how to fly, 172
 types of, 169
Monoplanes, 15, 62, 64
Montgomery, 30
Motor, small, 220
Motor glider in flight, 218
Motored plane, how to glide, 215
 pilots as glider pilots, 39

N

Nails, copper, 201
 kinds, uses, 177
National Advisory Committee for
 Aeronautics, 180, 208
National Aeronautic Association, 165
National Glider Association, 40, 201,
 219

O

Obstacles, 83, 124
 avoiding, 98
"On the step," 126
Outboard motor, 127
Overhauling, 209

P

Parachutes, 161, 224
Parasite resistance, 73, 201
Parts, 181
 extra, 209
Path of flight, 82, 124
Physical qualifications, 37
Pilots, 5
 qualifications of, 36
Pitch, 75
Plan, enlarging, 180
 of gliders, 181
 for soarers, 180
Planes, types of, 15
Plywood, rib, 187
 uses, 177
Pontoons, 122
 wing tip, 122
Position, choice for take-off, 81
Precautions, take-off, 89
Precipitation, 51
Production, mass, 59
Profile of wing, 180
Propellor, 68
Provisions for long flights, 161

INDEX

R

Radio sets, use, 162
Records, official, 165
Repairs, 208
Ribs, 184
 block, 186
 braces, 186
 false, 191
 rigid, 188
 rim of, 187
Rocket planes, 221
Roll, 75
Rudder, 15, 77, 78, 198
 bar, 15
 in slip or skid, 120
 in turn, 114

S

Safety belt, 194
Sailing, water glider, 126
Schools, 10
 airplane, 226
Schroeter, J. P., 11
Schulz, Ferdinand, 34
Sea Sled, 127
Seam tape, 178
Seams, taped, 198
Seat, 195
Self-instruction, 10
Shearwaters, 143
Shock cord, 19, 219
 take-off, 86
Shop, 175
Signalling, 162
Ski, 65
Skid, 119, 120, 195
 box, 193
 tail, 196
Skidding and slipping, 120
Slip, 120
Soarer, advanced type, 60
Soaring, 17, 132
 static, 145, 149
 where done, 133
Soaring flight, progress of, 217
Solo, 220

Span, 15, 71
Spars, 188, 196
 box type, 189
 fittings for, 190
 I-beam type, 188
Speed, air, 68
 flying, 20
 relative sinking, 3
Sprayer, paint, 179
Stability, birds', 141
 of models, 170
Stabilizers, 196
Stalling, 72
Stalls, 20
 climbing, 92
Steel tubing, 195
Steep slopes, 82
Stick, 15, 198
 forward in turn, 115
 movements, 77
 use, 113
Stinson, E. D., 227
Stinson Aircraft Corporation, 227
Storms, 162
Streamlines, 72
Streamlining, 33
Struts, 199
 fittings, 204

T

Tail of bird, 142
Take-offs, 19, 81
 crew, 86
 cross-wind, 81
 difficulties, 91
 first, 95
 methods of, 84
 things to remember, 91
 water glider, 124
 into wind, 81
Tapered wings, 180
Teaching, methods of, 6
Terms relating to wings, 70
Terrain, 3
 formations, dangerous, 137
 irregularities of, 137
 suitable for gliding, 11

GLIDING AND SOARING

- Testing glider, 207
Thoret, Lieut. J., 213
Tire, balloon, 196
Tool kit, 209
Torque, 121
Tow rope, 86, 98, 99
Towing glider, 85
 behind automobile, 18
 by boat or car, 99
Towline, 124
Training, glider, 226
 ground, 13
Transporting glider, 203
Triplanes, 15, 62
Trussing, 199
Tubing, use, 176
Turnbuckle, 200
Turns, 22, 114
 going into, 116
 S-, 118
 steps in making, 115, 117
 things to remember, 121
- U
- Undercarriage, 14, 195
Uses of gliders, 223
- V
- Variation, compass, 160
Visibility, night, 164
Vision, 38
- W
- Waco, 227
Waste, 183
Water glider, appearance, 122
Waterplane, 127, 128
Waterplaning, 127
Weaknesses, 209
Weather, bureau, 139
 conditions, 162
 forecasts, 53
 maps, 52
 predicted by clouds, 51
- Wellfleet, 10
Wheels, 14, 196
 landing, 65
Whittelsey, H. N., 227
Whittelsey Manufacturing Co., 227
Winds, 45
 aloft, 47
 currents, 7, 133
 horizontal, 138
 science of, 224
 direction, importance of, 137
 flow lines of, 134
 how to measure the velocity of, 46
 Lilienthal's theory, 136
 local, 138
 methods of studying, 7
 strata, 138
Wings, 64
 assembling, 190
 birds', action, 140
 cantilever, 184
 center of pressure, 207
 construction, 184
 control methods, 62
 effect of, 69
 externally braced, 184
 flapping, 140
 flexible, 226
 semi-cantilever, 184
 straight, 59
 strutted, 185
 tapered, 59
 types of, 184
 warpable, 226
Wire, 179, 199
 bracing, 191
 drift and anti-drift, 191
 landing and flying, 200
 tension of, 205
Women as glider pilots, 37
Wright, Orville and Wilbur, 25, 29,
 140, 186
- Y
- Yaw, 75

