

PETROL-ENGINEED
MODEL AIRCRAFT

C. E. BOWDEN, A.I. MECH. E.

PETROL - ENGINED
MODEL AIRCRAFT

PETROL-ENGINEED MODEL AIRCRAFT

(WITH NOTES ON DIESELS)

By

Lt.-Col. C. E. Bowden, A.I.Mech.E.



PERCIVAL MARSHALL & CO., LTD.
23, Great Queen Street, London, W.C.2.

CONTENTS

<i>Chapter</i>	<i>Page</i>
PREFACE	vii
I. A BRIEF HISTORY OF THE PETROL-DRIVEN MODEL AEROPLANE	1
II CHOOSING THE TYPE OF MODEL TO BUILD ...	15
III THE POWER UNIT AND ITS MOUNTING ...	20
IV THE IGNITION SYSTEM, AND CONTROL OF FLIGHT DURATION. A BATTERY AND TIMER CARRIER	54
V AUTOMATIC STABILITY AND DESIGN, INCLUD- ING NOTES ON SLOTS AND AIRFLOW ...	71
VI GENERAL DESIGN FEATURES, TO ENSURE RELIABILITY AND PREVENT DAMAGE ...	93
VII MAKING THE DRAWING, BEGINNING CON- STRUCTION. METHODS OF CONSTRUCTION INCLUDES :—THE FUSELAGE—UNDERCAR- RIAGE—WHEELS—WINGS AND TAIL UNITS— WITH NOTES ON MATERIALS AND TOOLS	97
VIII THE MIDGET MODEL	147
IX PROPELLERS	158
X A HIGH WING COMPETITION MODEL WITH WING TIP SLOTS	165
XI A BABY HIGH-WING MONOCOQUE MODEL ...	170
XII A LOW-WING EIGHT-FOOT SPAN, AND SEMI- SCALE MONOCOQUE MODEL	175
XIII FLYING BOATS AND FLOATPLANES ...	182
XIV AN AMERICAN LINE FLYING MODEL, WITH REMOTE CONTROL	193
XV EXPERIMENTAL MODELS	204
XVI RADIO CONTROL OF MODEL AIRCRAFT. (BY C. R. JEFFRIES)	210
XVII FLYING A PETROL MODEL	223

FOREWORD

A BOOK by Colonel Bowden on internal combustion-engined model aeroplanes scarcely needs any introduction, as the author is too well known in the world of model aviation to be regarded as other than a master of his subject.

I feel, however, that I must bask in a certain amount of reflected sunshine, as, by very good fortune, I was present at Heath Row Aerodrome over ten years ago and witnessed the bi-plane "Kanga's" successful struggle against Isaac Newton's discoveries to the tune of a very convincing record flight, which was the forerunner of steady development and progress in subsequent years.

Over five years of war have caused a break in the activities of the petrol model aeroplane, but there is evidence that its return has already begun, and the sight and sound of those strangely "doodle-bug"-like craft—cutting motors and silent glides will ever bring back memories to many—can only presage better times ahead, and still further improvements in design and performance.

It is appropriate that this book should appear at this moment, and I recommend it to all whose air-mindedness finds expression in the model aeroplane.

J. E. PELLY FRY,

Group Captain, R.A.F.

PREFACE

SOMEONE asked me why I was writing a book on such an unusual subject. The answer is quite simple . . . Enthusiasm for that subject.

Enthusiasm for the petrol-driven model aeroplane in my case has never died, and I feel sure that if you are a beginner at the game, once you start, it will never die in your case either—more particularly if you start correctly. My reason for writing this book is to help beginners to start on the right foot.

The designing, construction, and flying of petrol-driven model aeroplanes is so intriguing because there is always something new to try out.

The power unit, its development and operation alone, will keep you interested; and to watch good flying is a thing of beauty, like the fascination with which one observes large birds in the air.

Then again, there is the sense of achievement, and one's hands and ingenuity are kept busy during the constructional period. Throughout our lives, most of us remain boys at heart—in fact, I think there is nothing sadder than to see a man who loses all his boyish enthusiasms and becomes completely weighed down with the dull cares of life.

In 1912, as a boy at school, I started building model aeroplanes, and since then, throughout the years of a full and interesting army life, and with many other interests and hobbies to claim my energies, the lure of designing and building models has never waned, with the result that my interest in full-sized aircraft is always active—and that is what our British youth must be in the future—air-minded.

Some years ago I wrote a short handbook on the petrol driven model aeroplane, but since then much water has flowed under the bridge of development, and experience impels me to set down the practical results obtained, in the hope and belief that they will save newcomers to the grand sport of petrol model flying, much wasted time and money, and help them to get going quickly.

The subject has become so large that it would be difficult to discuss all the different methods of construction of each item. I propose, therefore, to give the simple methods I have evolved, or have adopted from other aeromodellers, and that I know from personal experience are reliable in operation, and easy to construct. I do not wish to suggest that my methods or designs are necessarily the best; there are always different ways of arriving at the same result in life.

I wish to thank the following publications for their kindness in permitting me to make use of material that has been published in their columns: *The Aeromodeller* . . . *Model Airplane News* (of America) . . . and *The Model Engineer*.

I am also very grateful to Mr. C. R. Jeffries for his contribution on Radio Control, and I do not forget my wife, who has so patiently typed and edited as a side-line to her war-time activities.

C. E. BOWDEN.

Porlock, 1945.

THE PLANS OF MODELS IN THIS BOOK ARE OF
MACHINES THAT HAVE FLOWN WITH CON-
SISTENT SUCCESS.

CHAPTER I

A BRIEF HISTORY OF THE PETROL-DRIVEN MODEL, INCLUDING THE DESCRIPTION OF SOME TYPICAL MODELS

THE success and popularity of the modern petrol-driven model aeroplane owes much to the patient experimental work, in the pioneer days of the movement, of British model engineers, who may be said to have been first in the field in producing really small engines suitable for model aircraft and in demonstrating their possibilities in actual flight. This refers to purely amateur experimental work, not research devoted to commercial ends, or scientific development in connection with "prototype" aircraft. The earliest records of experiments with petrol-driven models in this country date back to 1908, but, owing to the difficulty of producing satisfactory engines of small size and light weight, interest in this method of propulsion lapsed until, in the years following the first world war, sufficient data on the design of small petrol engines had been accumulated to ensure their complete reliability and enable bulk, weight, and complication to be reduced to a minimum. Other forms of motive power had been tried, with some degree of success, including steam, compressed air and CO₂ engines, but their inherent disadvantages prevented their becoming really popular. It was not until 1932 that the overwhelming advantages of the petrol engine for model aircraft propulsion were finally proved, again by British designs;

The photographs of models in this chapter are of out-of-date but historical, types. Models with modern lines are shown in later chapters

and from then onwards the popularity of petrol-driven models has increased rapidly.

These facts are sometimes in danger of being forgotten by the modern user of model aircraft engines (mostly commercial productions imported from abroad) and some emphasis on the part played by British pioneers in this field is well justified.

The petrol movement just prior to this world war No. 2 had made vast strides in America, where literally thousands of men and boys were making and flying models. In France and Holland the petrol model was just catching on seriously, and in Germany the hobby was being encouraged by the production of a number of commercial model aero engines of varying design, although none of these found their way to this country.

Although England was responsible for starting off the world petrol movement in 1932, we in this country could only number our petrol models in hundreds. Nevertheless, we were getting down to the production of the model aero engine, and had produced some that would undoubtedly have made the movement more popular if the war had not intervened.

It must be admitted, however, that one of the reasons for the great number of petrol models in America was the fact that model aeroplane engine manufacture had been laid down on large production lines, with the result that efficient and light little power units were obtainable quite cheaply.

By the time these engines and their ignition coils reached this country, the price had become rather alarming, and the few British commercial engines made on small-scale production lines were very little or no cheaper.

Most model engines for aero work have been developed from model boat engines. They must in future be specially designed for aero work and some practical

suggestions to this end are made in Chapter III. Before we discuss our modern models, it is interesting to study quite briefly the main outline of history that has led up to the present-day model.

In 1874, Penaud produced the first rubber driven model to fly. The first recorded power flight other than by rubber was by Stringfellow who, in 1848, at Chard, succeeded in flying a steam-driven model inside an old lace factory. This model was launched along a wire. At the end of a long room the flight of the model was arrested by flying into a sheet.

Later on, in 1893, Professor Langley began to make experiments, and these resulted in a successful flight in the open air by his now famous steam monoplane. His model was a double monoplane with wings of equal span and chord. The model had a backbone of steel to the centre of which was attached a boat-shaped carriage for the engine. The two planes were covered with silk and braced with a number of wires. They both had a considerable dihedral angle (an open V), and this was one of the reasons for the model's success. There were two screw propellers turning in opposite directions to eliminate torque. Langley launched his model from the top of a houseboat on the river Potomac. This was in the year 1896, and several encouraging flights were made. Langley followed this up with a full-sized machine which unfortunately crashed, and so it was left to the Wright brothers in 1903 to make the first flight in history with a full-sized power-driven aeroplane.

Langley built two petrol models, his first model being a quarter-size machine constructed in 1899. The engine was a failure on this model, so in 1903 he built another quarter-size model with which, it is claimed, he made the first model petrol flight in history, on August 8th of that year. The model weighed 58 lb., the sustaining surface was 66 sq. ft. and the horse power between 2.5 and 3.

The engine was constructed by Mr. Manley, and, to quote Langley's own words, "The flight was quite satisfactory, but not as long as had been expected." No time was recorded.

The first petrol record officially observed was made in 1914 by Mr. Stanger with a "canard" biplane (tail first). This model set up a record flight of 51 sec. and showed great stability in the air, but damaged itself on landing. The model had a V twin-cylinder engine and weighed 10¾ lb. complete. The engine weighed 2 lb. 12 oz. and revolved at 2,000 r.p.m., with a propeller 22 in. diameter of 18 in. pitch. The engine was a four-stroke and had automatic inlet valves, with mechanically-operated exhaust valves. This biplane had a span of 7 ft., chord 1 ft. and a gap of 13 in. between planes. The elevator span was 30 in. with a chord 8 in., the total length of the machine was 4 ft. 2 in.

Prior to this record flight, two French brothers had made a flight in front of a large crowd of spectators in France, but their machine was tethered to a pole by a line, and could therefore not be called a free flight. It therefore lost much of its practical value, although the engine was of note, and line-control enthusiasts will note with interest this early example of their favourite method of flight.

Another outstanding experiment about this period was the Bonn-Meyer engine for model aircraft. It also was a V twin four-stroke engine, and its weight with battery and coil was 11 lb. 2 oz. As a contrast, engines can now be purchased weighing approximately 2 oz. bare weight, with a coil weighing from 1½ to 2 oz., and diesels weighing 1½ oz.

The great war of 1914 to 1918 put a stop to model work, and after the war Mr. E. T. Westbury, well known in the world of model engineers for his model petrol engines of all types, constructed a 52-c.c. two-stroke petrol aero engine called the "Atom I." This engine was

fitted with a flywheel magneto and a mixing valve in lieu of a carburettor. It weighed 5½ lb., and drove an airscrew of 2 ft. diameter and 18 in. pitch at 3,000 r.p.m. In 1925 the Cranwell R.A.F. Boy's Wing Model Aircraft Society built a half-scale model of the C.L.A. 3 single-seater light plane, designed by Flight Lieut. Comper, who later became well known through his famous little full-sized "Comper Swift" sports plane. The model had a wing span of 11 ft. 6 in., and weighed 14 lb. Unfortunately, it was not flown owing to restrictive regulations, but it was eventually used for instructional purposes at the cadet college.

Another machine then emerged before the public eye called the "Dowsett Hawk Special." This machine was a strut-braced parasol monoplane, but it did not do any flying of note. It was not until 1932 that Mr. Stanger's record flight of 51 sec. was beaten. Mr. Stanger therefore held the record for 18 years.

The "Atom I" engine was regarded as being too large for the propulsion of models within the scope of the amateur constructor, but it was used for systematic tests and experiments to prove the practicability of petrol-driven model planes, and to establish data for the design of smaller and equally reliable engines. At first, owing to the rather tardy interest displayed by aero-modellers in this venture, the engines developed from the design ("Atom II" and "Atom III"), both of 30-c.c. capacity, were of a type specially suited for model power boat propulsion, but the prospect of producing an engine of still smaller size and lighter weight for model aircraft was constantly kept in mind.

In 1928, Mr. Westbury started a campaign to interest aero-modellers in the model petrol engine and convince them that it was practicable and reliable for their purpose. Several lectures and demonstrations were given before London clubs and the Society of Model Aeronautical

Engineers, and other institutions, in which particulars of power-weight ratio and other essential data were produced, and model engines shown working. As a specialist in the development of the model petrol engine, Mr. Westbury's aim was to secure the co-operation of model aircraft designers in producing machines of a type suitable to make use of this motive power. Several well-known aero-modellers of the time began to take a definite interest, including Mr. J. Pelly Fry (since famous as a Mosquito pilot) and Mr. Juste van Hattum; but the first fruits of practical collaboration were produced when I turned my attention from rubber to petrol and built a cantilever winged biplane with certain stability and anti-damage features, a machine which was also portable. This model was called "Kanga," after Mr. A. A. Milne's well-known story of the mother kangaroo who used to hop along. After a few preliminary flights on Hounslow Heath, the plane was taken to Mr. Fairey's (now Sir Richard Fairey) Great West Aerodrome at Hayes, and put up an officially observed record flight of 71 sec. The flight was arrested by a clock mechanism which automatically throttled the engine back after 60 sec. The engine was an old "Wall" 28-c.c. two-stroke, considerably modified by Mr. Westbury after use in one of his speed boats. It weighed $2\frac{3}{4}$ lb., less ignition gear, and drove a 24-in. propeller. The ignition gear weighed 15 oz., the total weight of the model being 8 lbs. 14 oz.

A description of this post-war record flight by an eye-witness is given overleaf, by kind permission of *The Model Engineer*. The flight was the beginning of the great petrol movement of to-day, for a number of enthusiasts followed it up with the production of petrol-driven model aeroplanes, in this country, and later in America. It proved that a simple stable and portable model was a practical proposition and not too costly for the enthusiastic amateur's pocket.

"In April, 1914, D. Stanger made the last record for a petrol-driven model aeroplane. This record of 51 sec. has stood for eighteen years. On Whit Sunday afternoon, at the Great West Aerodrome, Captain C. E. Bowden broke this more than once. For the trials Mr. Cl R. Fairey, who is a patron of the Society of Model



Fig. 1. The author's early bi-plane model "Kanga," which set up the first post-war (1914-18) record. The model is here seen being run up on the ground by the author, in 1932.

Aeronautical Engineers, very kindly gave permission for the use of the Fairey Aviation Company's aerodrome at Heathrow.

"The best timed flight was 71 sec. This may not seem a great advance on the old record, but it must be remembered that Capt. Bowden's present machine is purely experimental, and that by a timing device the engine was throttled down after a run of 60 sec.

Those who know Capt. Bowden's rubber driven machines will not be surprised to learn that for his first essay in petrol-driven work he has kept to the type with which he is most familiar—a cantilever biplane.

“ ‘Kanga’ may be regarded as an enlarged edition of the Bowden general purpose biplanes. The span is

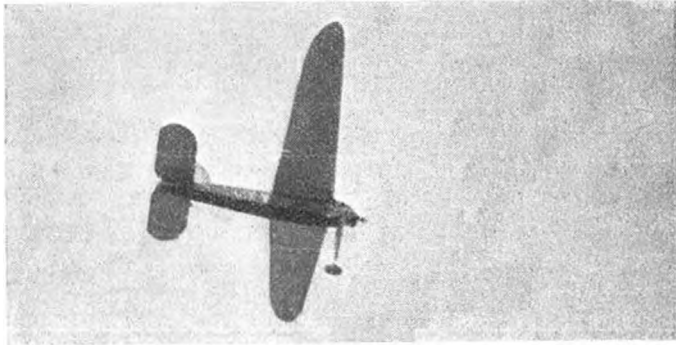

Fig. 2. The author's "Blue Dragon" early record holder, seen gliding overhead and narrowly missing some power wires. Taken in Scotland at the end of a 17 min. flight on the plane's first day out.

7 ft. and the total weight is 8 lb. 14 ozs., of which 3 lb. 8 ozs. is power plant and 6 ozs. timing clock mechanism. The engine is a Wall two-stroke which has been 'hotted up' by E. Westbury, of Halton. The ignition is of Westbury design and making. It weighs 18 ozs., including $4\frac{1}{2}$ ozs. of wiring due to the experimental nature of the machine.

“ The timing device to limit the duration of flight is most ingenious. At present it is, for convenience, fitted outside the fuselage, and must add considerably to the resistance. This will doubtless be altered on future machines, and that there will be future machines from the same designer the writer can give every assurance. A small clock is set to run for any pre-arranged time

before pulling a hair trigger, which in turn is connected to the throttle control. Another most important and equally ingenious fitting is the ignition control, which breaks contact and stops the engine on landing, thus leading to economy in airscrews and prevents damage to the engine. In the air a small flash lamp battery provides the current for ignition. On the ground it is relieved of this work by an accumulator. The under-

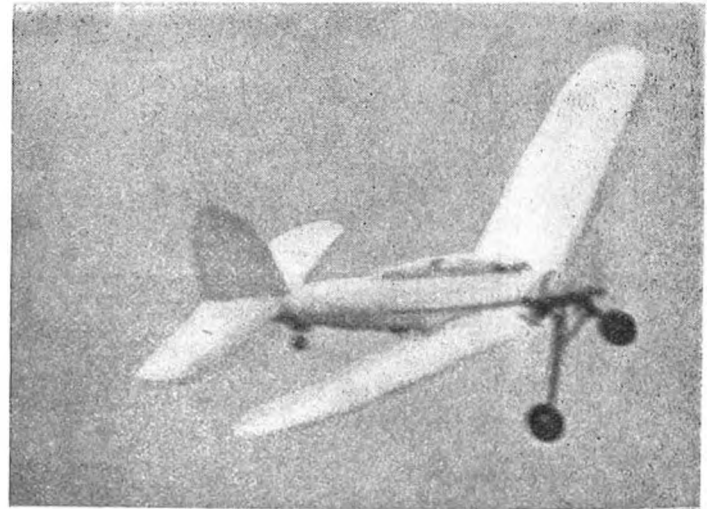

Fig. 3. The first monocoque low-wing to be built is here seen in the air near Birmingham, in 1936. This was built by the author.

carriage is a simple split type with spring legs. The wheels were specially made for the machine by Messrs. Dunlop.

“ The operations involved in commencing a flight are these. The timing clock is set. The accumulator is plugged in, contact is made and the propeller swung. After the engine is started there is a quick succession

of events. The ignition is switched over to the battery, the accumulator disconnected, the clock started and the machine released. After leaving the ground it commences a climbing turn, and continues to circle while the engine is running. Then the clock does its job, the engine slows down and the machine glides to earth.

"There may be greater thrills in model work, but the writer has never seen anything quite so exciting as the flight of a petrol-driven model aeroplane.

"On the day this record was made the weather was sultry, and more would have been done had not rain interfered more than once with the work.

"The timekeepers were J. E. Pelly Fry and R. Langley. A third witness was Warrant Engineer H. Harris, R.N.(Ret.). During the afternoon J. E. Pelly Fry produced his new rubber-driven model 'Stork' and made a first flight of 89 sec."

After this flight I decided to produce a smaller type of petrol model, in order to encourage petrol-model flying. I visualised one that could be carried to the scene of flying with reasonable ease, and then be erected quickly. At great speed, Mr. Westbury designed and produced the 14.2-c.c. two-stroke "Atom Minor" engine, whilst I produced a simple 7-ft. span cantilever monoplane. The wings were made in two detachable halves for portability, and all major components, such as wings, tail, fin and so on were kept in position by rubber bands. This new model, "The Bee," shortly created a new official record of 8 min. 42 sec., "out of sight," winning the Sir John Shelley Power Cup in 1933 at the same time.

In 1934, my "Atom Minor" engine was considerably hotted up by my friend and fellow-conspirator, Mr. A. D. Rankine, of Ayr, the well-known speed boat enthusiast. The engine was now capable of extraordinary power for its size in those days, and, incidentally, when installed in

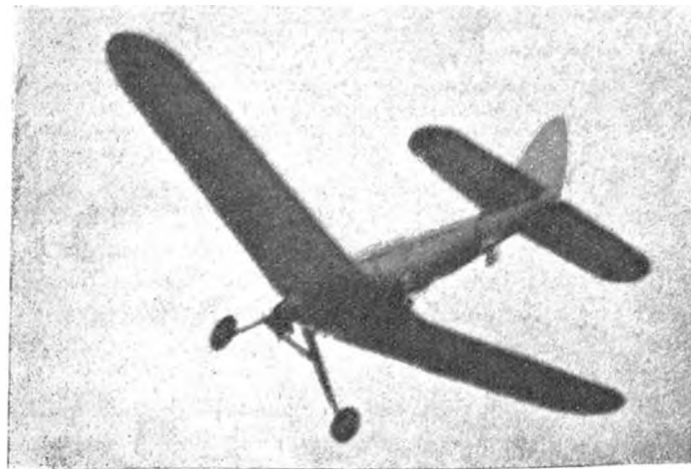

Fig. 3A. The author's monocoque model on the ground.

my hydroplane hull (speed boat), set up a world's "C" Class hydroplane record. I also fitted this engine into an 8-ft. span model called the "Blue Dragon," with which I won the 1934 Sir John Shelley Cup, and set up another record of 12 min. 48 sec., "out of sight."

The interesting point about this model was the intro-

Fig. 3B. The same model in flight.



duction for the first time of a detachable engine mount, held in position by rubber bands, which has since become a common feature of the petrol model aeroplane. I also fitted an undercarriage arranged with a backward movement first, followed by an upward movement, two features that are generally used on petrol models to-day.

A number of fellow-enthusiasts were busy about this time. Mr. Bishop first made a heavily-loaded scale



Fig. 4. A sunset scene. Perhaps the first high-wing monocoque model to be produced is here shown flying at Tachbrook in the early days, it was constructed by the author and had a 6-ft. span.

“Comper Swift,” and followed this model with his very successful and lightly-loaded biplane “Endeavour,” powered by a four-stroke 30-c.c. engine.

Mr. Stalham mounted an interesting flat twin overhead valve 30-c.c. engine into a model he called “Peggy.” He entered all the early power competitions with this machine.

Mr. B. K. Johnson made an exceptionally light machine with an “Atom Minor” engine installed. As usual in

those days, it was made of hard wood and weighed only $4\frac{1}{2}$ lb. complete, with an 8-ft. wingspan. It flew very well until one day its wings folded in the air at a considerable height and the model met with disaster.

Messrs. Andrews, Bennett and Collins produced a scale De Haviland Moth that flew reasonably well, but



Fig. 5. The first petrol model to fly at Gibraltar. This shows one of the author's early models caught just after taking off from the race course. The course is now a huge aerodrome with one end built well out into the sea. The “Rock” is seen in the background.

naturally suffered damage fairly frequently, as it was an early “scale” attempt and the undercarriage was in the scale position. The bracing wires were also a source of trouble.

Mr. F. Harris’s “Flamingo II” was a well-known performer at those early competitions. Its secret was a light wing loading. The model had a 15-c.c. four-stroke engine, previously installed in a speed boat. It was noteworthy for its slow flying abilities.

In the meantime, I had tackled the petrol-driven low-wing model and also the monocoque type of model. Petrol models, since these early days, have been built in considerable numbers, and it is therefore impossible in this short history to include further descriptions. (A full description of rubber and petrol models is contained in the author's book *The History of Model Aircraft*, published by The Harborough Publishing Co. Ltd.)

In later chapters of this book photographs of modern type models will be found. Perhaps the most ambitious project of recent years has been Mr. D. A. Russell's large scale "Lysander" of 10 ft. wing span. This model has a four-cylinder American two-stroke engine, and is fitted with flaps. It is to be fitted with wireless control.

CHAPTER II

CHOOSING THE TYPE OF MODEL TO BUILD

MANY an enthusiastic newcomer to the hobby of petrol-model aeroplane construction has thrown away much effort and money, and had his enthusiasm damped, through the discouragement caused by the failure of his model to fly—and keep on flying—with reliability and reasonable freedom from damage. This has all come about through starting with too-ambitious ideas of a flying scale model, and without having mastered the simple fundamentals of stability and construction that will give reliable operation. It is necessary to begin in a modest way, and that is in no way as simple to do as it is obvious, because the average man will not be content to learn through first making a simple model.

Beginners are often led away by the beautiful appearance and flying capabilities of a highly streamlined scale, or semi-scale, model. From the early days of petrol-model flying I have watched so many beginners start off with ambitious ideas, fail, and then turn back to the simple model. I can also recall the numerous cases of those who have turned to the simple model, learnt the fundamentals and surprisingly quickly become constructors of highly intriguing semi-scale and flying scale models. The reader will probably be attracted either by kits of parts or designs of scale models, and want to wade into building one. My advice is—"Don't!" Start on a simple and well-designed machine, and then, having gained your experience and learned the ethics of good rigging and flying—build what you fancy. When a fighter pilot is taught to

fly, he is not at first put into a four-hundred-mile-an-hour fighter, but is taught the fundamentals of flying on a small simple machine. The main object of building a petrol model aeroplane is to see it flying with stability and making pretty landings after soul-satisfying glides. I can imagine nothing more depressing than watching a model careering about the sky wildly and out of control until it finishes with a horrible crash.

In this book I am going to discuss simple methods of construction that will give the minimum amount of trouble, both in the building stage and under flying conditions. I also intend to give the reader a choice of simple models to start on, followed by semi-scale type models with flying ability as the foremost aim. Any true scale model must suffer by having the undercarriage too far back for good landings every time, and therefore possible damaged propellers, and even sometimes engines. Absolute scale fins and tailplanes are not usually suitable for perfect stability. If these points are carefully modified without detracting much from the appearance, then success will be obtained.

The Beginner's Model

The best model for the beginner is undoubtedly a lightly-loaded high-wing model as summarised at the end of Chapter V and in Chapter X, which gives a design for a beginner's model. This model will fly slowly, be controllable, and suffer the least damage. A great deal of fun, interest and amusement is to be got out of a slow-flying, stable model of reasonable appearance.

Designed by the Owner

If the beginner does not like the idea of building a machine of someone else's design and wishes the creation to be entirely through his own efforts, and yet is not *au fait* with model building, I would suggest that he

designs his model on lines summarised in Chapter V, which deals with automatic stability and design, and that he carefully digests Chapter VII—"Methods of Construction."

An important thing to remember is to keep the model simple, strong, and yet with a light wing loading of not more than 14 ozs. per square foot. A wing loading of between 8 ozs. and 10 ozs. will be better still. Wings should be made cantilever and never strut or wire braced, as in the event of a heavy landing or a crash struts and wire bracing always become deranged, and the model is out of true for the next flight.

The wings, engine mounting and tailplane, etc., *should always* be made easily detachable and held in position by some form of rubber retention band, so that these components can knock off in bad landings and possible crashes. This also applies to the engine, which should be on a detachable mounting, held in position by rubber bands or springs. Much damage can be saved in this way. The main plane should slide for adjustment, but once the correct position has been found for a good glide this position should not be altered (see Chapter XVII—"Flying a Petrol Model"). The undercarriage should be well forward and have the correct backward movement, as described in Chapter VII.

The Free-lance Design

To my mind, the free-lance semi-scale design is the most intriguing, for it is entirely the result of the designer's own brainwave, and shows individuality, which is always a source of interest to other enthusiasts. The designer can make a compromise of flying ability and good looks. He can lay out new shapes and methods of construction, and when the model flies he can at least feel that no one else thought of it. It is part of himself and, however dreadful it looks to other eyes, it is his own child; and fathers and

mothers are notoriously fond of their own children. The worse they look, the fonder of them they seem to be!

The Scale Flying Model

Many people take a fancy to a certain full-sized aircraft and would like to produce a scale model of this machine that flies. I fear that quite a number produce the model and it looks very well, but no thought has been given to the necessary modification in design so that the model will fly, nor has it been considered in some cases whether the prototype *can* make a suitable flying model. The result is that the owner either becomes discouraged at damage incurred in flying (if it will get into the air at all), or he places the model at various flying meetings for the admiring crowd to view, but the model never takes to the air. Neither of these situations can be called satisfactory.

There are certain types of full-sized aircraft which with very little alteration lend themselves excellently to the production of scale flying models. The scale enthusiast must be quite clear on the fundamentals of stability as described in Chapter V. He would do well to study his chief fancies and see if they fit in with the main principles and whether a slight alteration of thrust line, perhaps a little more dihedral and a slightly larger tailplane; and possibly even a little more wing area will fit in without upsetting the general lines and scale effect of the original. In this way a scale model can often be a great flying success and is certainly an achievement worth attaining. Whatever the loss in scale effect, do not forget to place the undercarriage as far forward as possible, or the model will nose over when landing.

The Large and Small Model

I doubt whether anyone has given more time to the development of the vest-pocket model than I have. As a

result, I am able to give a considered opinion as to the relative flying ability of the large and small model.

There is no doubt that the beginner will be well advised to start off with a medium-sized or large model—that is to say, a model with a 4-c.c. to 10-c.c. engine. The larger engine is far easier to start as a general rule and it is less tricky to operate. I am only considering the best and well-known engines on the market.

There are a number of midget engines from 1.5-c.c. to approximately 2.5 c.c. Some of these are excellent little motors, but one must admit that in certain cases they are temperamental even in the hands of an “expert.” The better known larger engines are now really very reliable and good starters, if the ignition wiring is efficiently carried out and the battery is in good working order. Again, the larger model flies better. It has a reserve of wing area for the ignition gear that cannot be reduced in weight in proportion to the midget engine. A great deal of fun and excellent flying can be obtained from the baby petrol model, however, and its very small size and portability are great lures. Nevertheless, I advise the beginner to start with the larger model and then tackle the babies later. In Chapter VIII the midget model and its problems are discussed.

There are certain good examples of baby diesel engines of from 1½ c.c. to 2 c.c. now on the market that are very suitable for midget models, because there is no weight of the ignition gear to be carried. These engines weigh from 1½ oz. to approximately 4 oz.

CHAPTER III

THE POWER UNIT AND ITS MOUNTING

General

HAVING decided upon the type and the approximate size of the model that is to be constructed, the prospective builder should now decide upon an engine of repute and of the correct weight, capacity and power output to suit his model.

Although the construction of the model petrol engine is not within the scope of this book and is generally regarded as beyond the capability of most acro-modellers, it should be pointed out that many amateurs have built their own engines quite successfully, and there is no doubt that this considerably enhances the interest of model aircraft construction, to say nothing of the satisfaction of the achievement when completed. Engine construction calls for much more complete workshop equipment than is usually required for airframe construction, including, as it does, a metal-turning lathe, and some specialised skill in metal work. Experience has, however, shown that this can be acquired, given the necessary enthusiasm and determination. Several designs for model aircraft petrol engines have appeared in *The Model Engineer* during recent years, including the later 6-c.c. version of the "Atom Minor" and the "Kestrel" 5-c.c. engine, both by Mr. Westbury. The latter design was produced specially to suit the facilities of the amateur constructor with limited workshop equipment, and proof of its success in this respect is furnished by the fact that several hundreds of these engines have been constructed, in many

cases by comparative novices, and used with success, not only in model aircraft, but also in speed boats and racing cars. Another excellent engine for amateur construction is the new British "Majesco," which sells as a very complete set of castings with plan.

For further information on model petrol engine construction, readers are advised to follow the articles on this subject, or to obtain Mr. Westbury's book on "Model

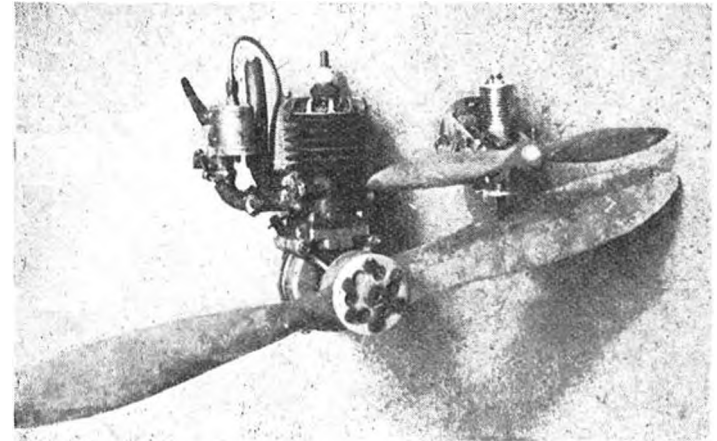

Fig. 6. The 28 c.c. engine used by the author in the first post-war (1914-18) record, seen beside a $1\frac{1}{2}$ c.c. "Mighty Atom." Their respective weights are 3 lbs. and $1\frac{1}{2}$ oz. (tare).

Petrol Engines." The many acro-modellers who are unable, for one reason or another, to construct their own engines, will find an ever-increasing range of commercial engines available to suit their requirements.

The success of the model as a flying machine can be completely made or marred by the engine. It is false economy to purchase a cheap or unreliable engine.

Owing to the fact that my interest in the small internal combustion engine has been as great as in the design and construction of the model aircraft itself, I have either

tried out or acquired practically every engine of repute produced in this country and in America since the early days of petrol model aeroplanes. All this has made me come to the very definite conclusion that, except for the man who likes to tinker, only well-tried engines should be purchased by the newcomer to the hobby. Also that, although the midget engines are in many cases reliable little fellows "packing an exceptional punch" for their size—the well-known engines of 4 c.c. to 10 c.c. are less tricky to operate, as the mixture control is less critical. Generally speaking, they also start more easily. This also applies to the miniature sparking plugs on the market; the larger size is more reliable. There is a pleasant reserve of power with the larger engines which the beginner will find comforting should his model weigh a little more than anticipated through constructional errors.

I am therefore going to assume that the beginner will wish to construct a *slow-flying, general-purpose model*, as suggested in Chapter II.

In these circumstances, the size of the model will be dictated more or less by the size and power of the engine chosen. I will therefore give a general indication of the span and weight of the model that any particular class of engine of repute may be expected to fly—provided always that the model is correctly designed and constructed in accordance with the chapter on design and construction, and provided that the construction is soundly carried out so that the model is truly rigged, i.e. components not out of line or surfaces warped.

Four-stroke and Two-stroke Engines

Either type is suitable for the model aeroplane and both have been used with success. The four-stroke engine generally throttles up and down better than its two-stroke brother, and is therefore more suitable for wireless-

controlled models, where the engine will probably require to be throttled back in order to lose height and then be opened up again for the climb. The four-stroke single-cylinder, if well balanced runs with remarkably little vibration. Its chief disadvantage is the complication of minute-sized valve gear, which is liable to damage in the event of a bad crash.

The two-stroke is the most usual type for model aeroplane work, chiefly because of its simplicity of construction, light weight for power and simple "petrol"

Fig. 7. "The Brown Junior" 9 c.c. engine, mounted on a Bowden detachable mount. This engine was one of the first 9 c.c. engines to be placed on the market and has always had an excellent reputation. Weight, $6\frac{1}{2}$ oz.; Bore and Stroke, $\frac{7}{8} \times 1$ in.

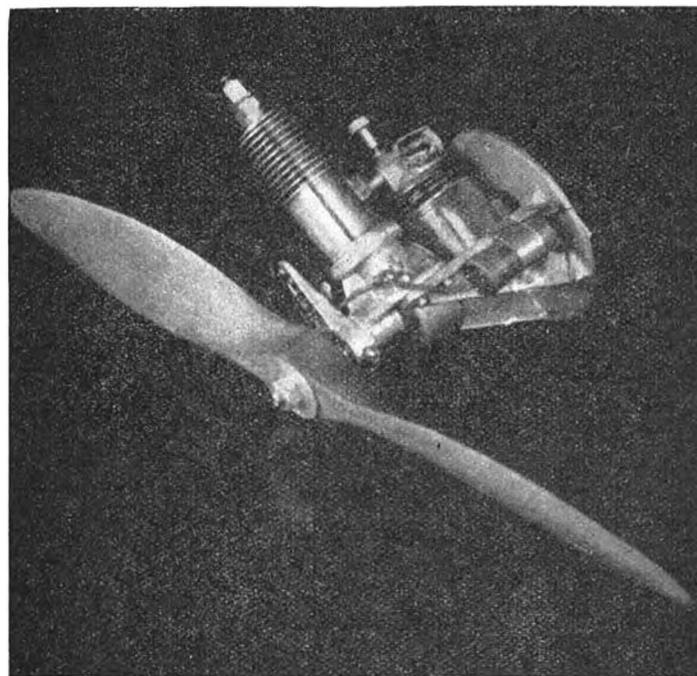

lubrication. Commercially-produced model aero engines are almost universally two-strokes. The simple features mentioned above naturally help to keep the price down, which is also an important consideration. To offset these advantages, the two-stroke engine is critical to mixture strength, and joints must be good. Air leaks are its bugbear. Good crankcase compression is vital.

Newcomers to model engines are advised to pay par-

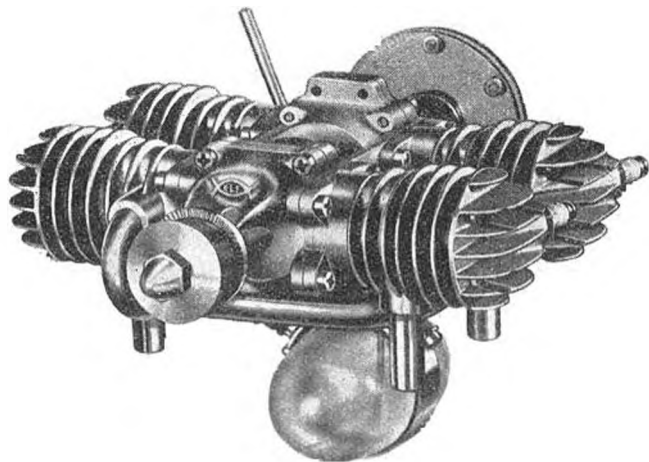

Fig. 8. "The Elf Four-cylinder" is a very advanced design. The author owns one. Weight, 9 oz.; .396 c.m., rated 1/3 h.p. This engine has a truly exciting exhaust note.

ticular attention to clean and well-adjusted ignition points. First-class wiring of the ignition system, with carefully-soldered joints, is important and the wiring should be kept as short as possible. Carefully-strained "petroil" mixture, clean sparking plugs and the *correct oil ratio* to petrol in the "petroil" mixture are all essential. On most model two-stroke engines this is as high as two or three parts petrol to one of oil. There are a few that

specify less oil. In the case of one little engine of repute (a very fine little engine), it is better to keep to two to one, not only for lubrication purposes, but because a mixture of three to one will cause the needle valve adjustment to become critical and touchy. This is due to a rather coarse needle valve, which has certain advantages in other respects.

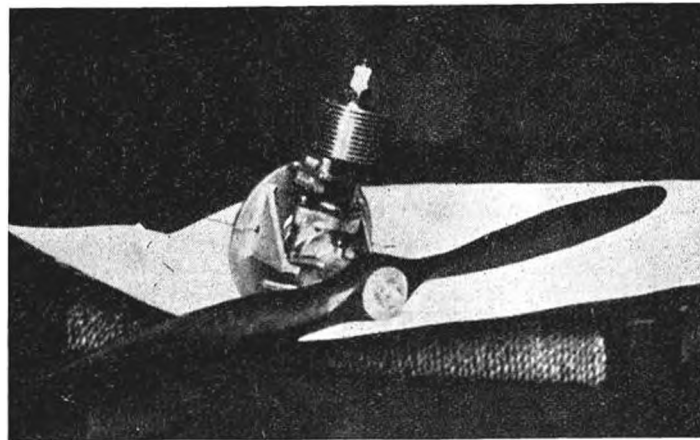

Fig. 9. A well-trying example. The 6-c.c. "Baby Cyclone" with a long history of achievement. Weight 6½ oz., less tank. The engine shown was one of the original engines to be received in this country from America, and has a long line of successes. It is here mounted on one of the author's detachable Elektron mountings.

Size of Engine

Having decided upon the type of engine, the constructor will have to consider the size of the engine. It is convenient to describe engines by cylinder capacity. The size of the model is dictated, as already mentioned, by the type of performance required, by the size of machine that is considered best for its operating and flying ability, and by its ease of transport. Although I have already given suggestions, the question of the aeroplane's size must

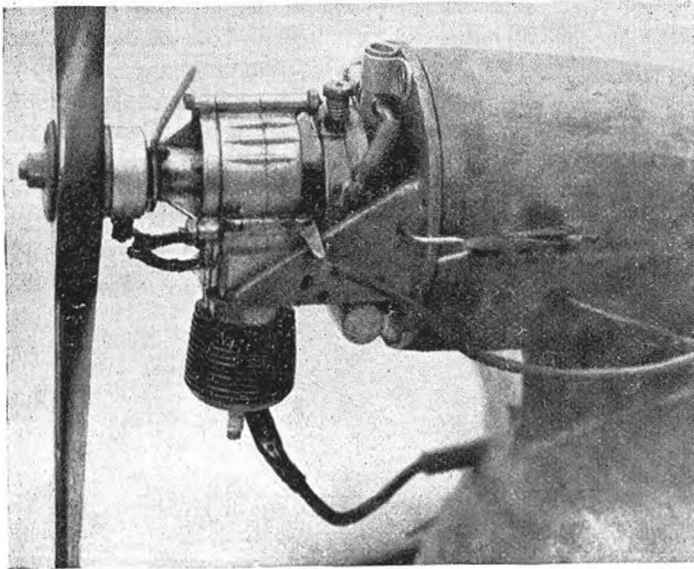

Fig. 10. The "Ohlsson 23." A very powerful little engine of 3.5 c.c. Bare weight 4 oz. The engine is mounted on a detachable Bowden Elektron mount, and has a special tank and lengthened induction pipe. These are not standard fittings but they improve the performance and reliable running.

obviously be a matter for the personal decision of each individual constructor. Perhaps I should mention here that there are sets of castings on the market for the amateur to make up an engine himself, if he has the necessary skill and facilities.

Classes of Engines Obtainable Commercially

Class I. The 30-c.c. Engine

This is usually adapted from the model speed-boat engine. It is rather large and heavy for our purpose, entailing a model of not less than 10-ft. span and up to 15-ft. span if we are determined to stick to our slow-flying,

lightly-loaded machine. A smaller-sized engine can fly a 10-ft. span model very efficiently. Therefore, except where we are intending to fly a considerable weight of wireless equipment, the 30-c.c. engine will probably be unnecessarily powerful for normal requirements. It must also be remembered that the weight of a 30-c.c. engine requires a very strong model. If a 30-c.c. engine is used for a wireless-controlled model, it should be one that is capable of effective control with the throttle. I have seen some really excellent flying of large machines by four-stroke single-cylinder engines. A flat twin 30-c.c. four-stroke with side valves is perhaps the ideal type. Personally, I do not like exposed O.H. valve gear, which may suffer possible damage. Modern knowledge has proved the side valve almost as efficient as the overhead

Fig. 11. The "Elf" horizontally opposed twin. Weight 3 oz. bare. A special twin coil is used and the total displacement is 198 c. in.

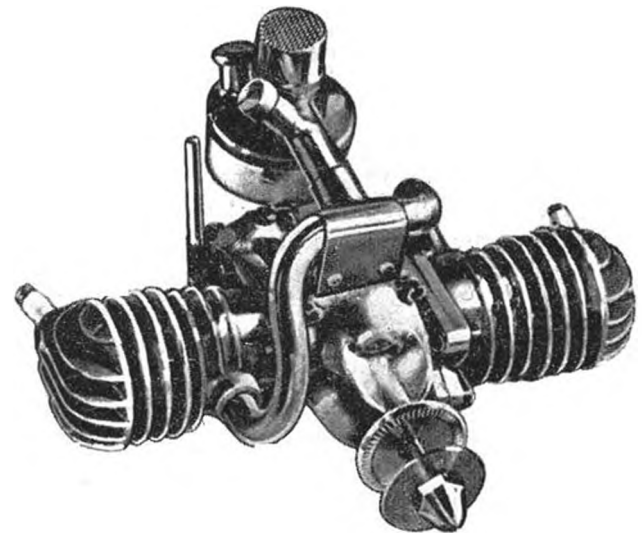

valve. Especially is this true at the medium speeds at which we run our propellers on such a large engine.

I always hanker after a side valve, flat twin with magneto ignition to be installed in a 10-ft. or 12-ft. span model with wireless control. That is something to come!

Class II. The 15-c.c. Engine

This is the next class in which commercially-produced engines are obtainable in casting form and occasionally in made-up form. This size is not as popular as it used to be now that the smaller type engines produce so much power and permit the construction of smaller and more portable models.

The engine should weigh approximately 1 lb., and a robust model of between 8 ft. to 10 ft. span, weighing about 6½ lb., can be produced. Perhaps I should mention that when I give a certain span I take it for granted that the reader will use a suitable chord, as suggested in the chapter on design. I knew of a model fitted with a 15-c.c. engine made with balsa longerons and covered with Jap tissue paper! It weighed 3 lb. with the heavy 15-c.c. engine, but it quickly became a mass of repair work, which is hardly the type of industry that the average man is keen about.

The first successful 15-c.c. model was that flown by myself in 1933 and the engine was specially built to my requirements by Mr. Westbury (as described in Chapter I).

I have held a number of records, including the first flying boat record, with engines of this class. There is no nonsense about getting off from grass or water, for there is an excellent power reserve. In fact, so much so that there should be some timing device to throttle back the engine a trifle once the model is airborne, otherwise the model will usually fly too fast and climb too steeply.

Class III. The 10-c.c. Engine

The engine around 10 c.c. is a very excellent size for ample power output and is capable of flying models of up to 8 ft. span. Lightly-loaded models of a greater span than this have been flown by 10-c.c. engines, whilst overpowered, quick-climbing models of considerably less span are often fitted with 10-c.c. engines. (There is a case on record of a lightly-built 15-ft. span model being flown by an engine of only 6 c.c. However, a wing span of between 7 ft. 6 in. to 8 ft. span is the most suitable size for engines of approximately 10 c.c.)

An 8-ft. span model makes a very fine flying model: it is robust, reliable and imposing in the air. Also, a well-designed large model usually flies more steadily than a very small model.

The only disadvantage of an 8-ft. span model is its size for ease of carriage in a car—even with split wings. The question is—Will the aero-modellist's family allow it?

Class IV. The 6-c.c. Engine.

The 6-c.c. engine is an excellent size, for it allows a smaller model, fairly easily portable and yet with excellent flying ability, for the wing loading can be kept light and there is a good reserve of power. Good examples of the 6-c.c. engines are not touchy as to mixture settings. Models of between 5 ft. to 7 ft. span are suitable for this class of engine. Modern 4.5 c.c. engines are almost as powerful as the 6 c.c. engine and may be considered in the above class.

Class V. Engines of 4 c.c. to 1½ c.c.

The light weight and small size of these little engines has a great appeal for many people who want to build a very small model.

One must remember that the weight of ignition gear still remains high—2½ ozs. for coil, ½ oz. for condenser, 2 to 2½ ozs. for baby accumulator or 4 ozs. for flash-lamp

battery, and 2½ ozs. for wiring and time switch ; therefore less weight can be permitted in the construction of the model. Also, these baby engines are more touchy with regard to starting and mixture control. I feel that everyone will eventually make one of these little models, but they are not the best type for the beginner's first model.

The secret for success undoubtedly is to produce a lightly-loaded powered glider, so that the engine has very little to do. See Chapter VIII, "The Midget Model."

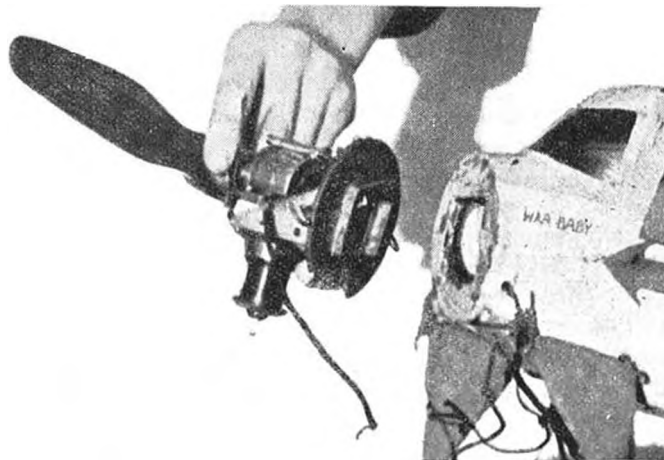

Fig. 12. An "Ohlsson 23" mounted on an Elektron mounting. Note the square cut in the nose-former of the fuselage. The casting is held to the fuselage by rubber bands and suitable wire hooks.

Power output varies greatly in this class. Some commercially-produced examples have a phenomenal amount of power for their size ; others are not so good. Many modern 4 c.c. engines are almost as powerful as a 6 c.c. engine.

Recently, midget diesels of from ½ c.c. to 1½ c.c. have been successfully produced. These eliminate the weight of the ignition gear. I have flown examples of these "little giants" with complete success in models that I have designed for rubber,

Installation

One of the best assurances against damage for the engine (the most expensive item in a petrol model) is to mount it on a knock-off detachable mounting.

If the reader will study Figs. 12 and 12A, he will see that

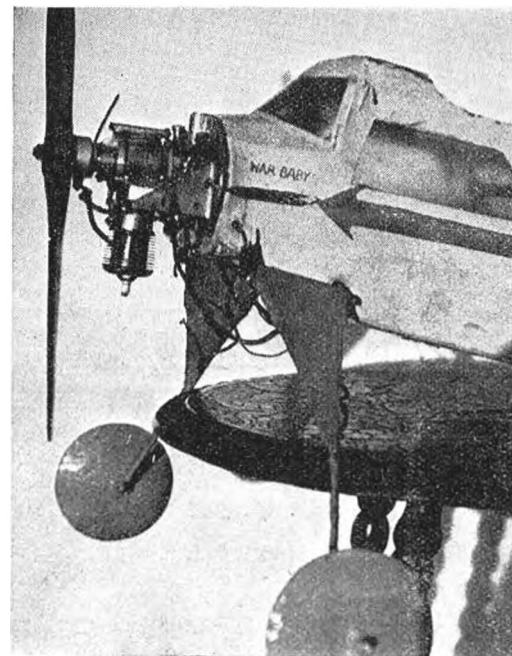

Fig. 12A. The "Ohlsson 23" in position.

the nose of the model is detachable and is held to the front former by rubber bands or springs. I prefer rubber bands, because the tension is easily altered. On to this detachable nose is mounted the engine. The engine is then quickly detachable for examination or repairs, and in the event of a crash can be knocked off instead of damaging the crankshaft or nose of the model. The

rubber band tension must not be too great ; on the other hand, it must be sufficient to prevent vibration.

Furthermore, it is extremely easy during the adjusting stage of a new model to alter thrust line by giving down thrust or side thrust as required, through packings being placed between the detachable mount and the fuselage front former. Different engines can quickly be installed and changed in the same model if they are mounted on interchangeable nose pieces.

These nose pieces can be made in the form of Elektron castings, as seen in preceding figures of certain engines mounted on them, or in the form of built-up wooden structures containing coil and battery. In Fig. 10 an Elektron light alloy casting is shown fitted to a fuselage.

Fig. 13. A "Brown" engine mounted on a detachable cone designed by the author and fitted to an early machine. The cone was also used as the petrol tank, whilst a miniature carburettor with a float chamber and throttle control was fitted with success.

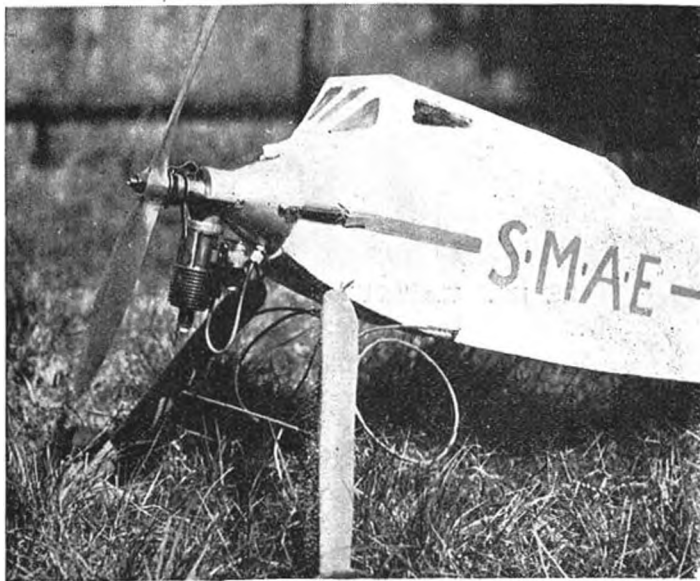

Fig. 14. A simple model by the author. In this case the detachable engine mounting is made from wood, and has the coil and battery mounted in it.

Fig. 14A. This type of square nose, designed by the author, allows a built up detachable nose with engine to be used, or the solid balsa distance-piece and Elektron casting as shown. By kind permission of Aircraft (Technical) Publications Ltd.



In Fig. 14 a simple detachable wooden nose piece is shown containing the coil as well as the engine. The whole nose piece and engine mount is made from three-ply and balsa wood.

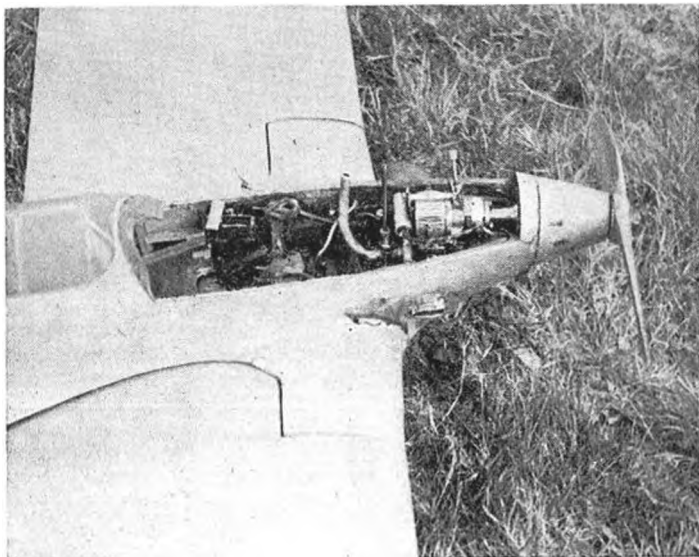

Fig. 15. Dr. Forester's shaft drive installed in a model with decking removed. The top of the engine crankcase can be seen.

The Elektron Casting

I originally made up a wooden pattern and then got a firm specialising in casting work to make me up a number of Elektron castings. These are quite cheap and very light, and Elektron is a very easy metal to drill or file.

"B.M. Models," of 43, Westover Road, Bournemouth, now sell the castings. For the man who does not want to go to the trouble of a casting, my No. 2 method, as shown in Fig. 14, is a simple solution. My friend, Dr. Forster, the well-known petrol model enthusiast, has

evolved an extension shaft drive for scale models, still retaining my old knock-off feature. The propeller and front of the extension shaft knocks off. (Fig. 15).

FIG. 16.

A RIGID ENGINE MOUNTING, WITH 'WOODEN BEARER ARMS.

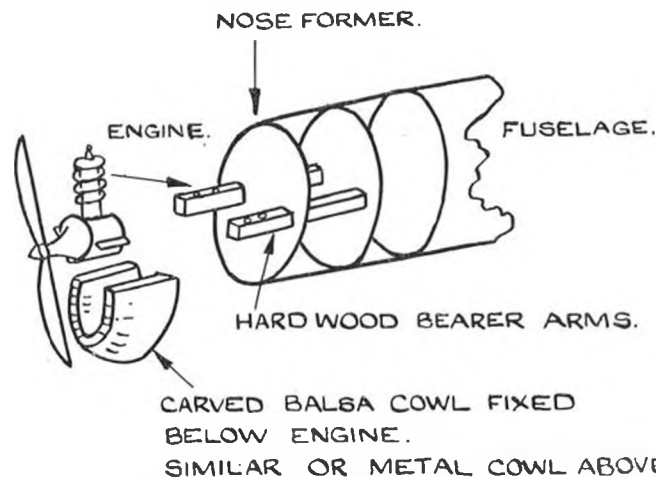

I fully realise that certain readers will not wish to follow my advice and, in spite of "the gipsy's warning," will want to mount their engines rigidly on wooden bearer arms. Fig. 16 will show how it is done in America and Fig. 17 will show how a certain amount of protection can be obtained even when using this method.

FIG 17
A SEMI RIGID -MOUNTING THAT
ALLOWS THE ENGINE TO PIVOT

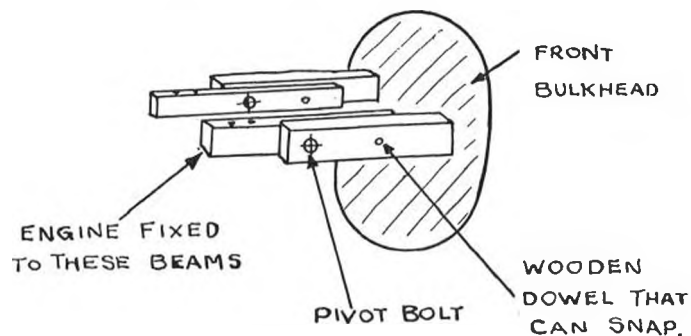

N.B. THIS MOUNTING HELPS TO SAVE PROPELLERS, BUT DOES NOT SAVE DAMAGE IN A SERIOUS CRASH AS IT IS RIGID SIDEWAYS.

It must be remembered that, if the detachable-type engine mount is made too large at the rear plate, it is inclined to be too rigid and not sufficiently easily knocked off. It then loses its anti-damage virtues. Engine cowlings are dealt with in Chapter VII under constructional methods.

Improving the Breed

I would go so far as to say that there is not one model aero engine designed at the time of writing that is

entirely suitable for its job. This may appear to be a rather sweeping statement and require some explanation. Space forbids a detailed examination of the problem, but I will endeavour to explain the main points of criticism that can be levelled at the model aero engine as we have known it up to World War II and suggest how they might be overcome in future design.

I do not for one moment wish to give the reader the impression that all the model engines that were purchasable before the war were bad—for this is very far from the truth, as the well-known examples were splendid little power producers. Nevertheless, they all suffered from certain snags that *could* be overcome. Some naturally suffered to a greater degree than others. Let us examine some of the major snags from the aero-modeller's point of view.

(I) *Mounting*

Engines are produced with large tanks and induction pipes protruding directly astern. It is very difficult to mount these on the highly desirable "knock off" mounting, and also to get the finger over the induction pipe to choke the engine for starting. It is often desirable to run engines inverted in order to obtain a high thrust line and for greater ease of cowling, and yet many engines have the induction pipe and the ignition control lever arranged so that the inverted position is not suitable.

It may be desired to run the engine upright, and therefore the design should permit of either upright or inverted running.

(II) *Tank Position and Mixture Control*

Very few engines indeed will run for a whole fuel tank full without the revolutions dropping through a change in the mixture strength, due either to the level of the fuel varying in a large and deep tank as the fuel is used up or

to a change of attitude of the machine in the air causing the level of the fuel to vary.

A large tank is not as a general rule necessary. A small shallow tank will help to keep the level more constant and this tank must be situated as shown in Fig. 18, so that the fuel is sucked up and the fuel is directly below the needle valve.

It is surprising how many baby engines are vastly improved as regards even running and constant power output if a long induction pipe is fitted. This long pipe provides a good column of air past the jet and helps to prevent blowback.

Dr. Forster has done a lot of useful experimental work in this respect and has proved this point on a number of his engines as well as my own. I also found this a most important point on my old "C" class world record-holding model hydroplane, "Jildi Junior," in the early days. The trouble is how to fit a long induction pipe. Dr. Forster's solution is ingenious, simple and efficacious. See Fig. 19 and also refer back to Fig. 10. It will be seen that the induction pipe from the "Ohlsson 23" 3.5-c.c. engine has been lead back from the cylinder and then curved upwards to the needle valve. The petrol tank is placed in front of the induction pipe orifice. The orifice is placed where it can be easily choked for starting by the finger. It has been found that practically any model engine is improved in control and smooth power output, as well as in consistent running without fading, by fitting an induction pipe of not less than 4-in. in length. Any increase of length above 4 in. makes little improvement.

(III) Contact Breakers

It should be quite obvious to all designers that contact-breaker points should be located so that oil cannot be flung on to them by centrifugal force by the crankshaft from the main bearing, yet how few engines have their

FIG. 18.

THE IMPORTANCE OF CORRECT
PETROL LEVEL TO ENSURE
EVEN POWER OUTPUT.

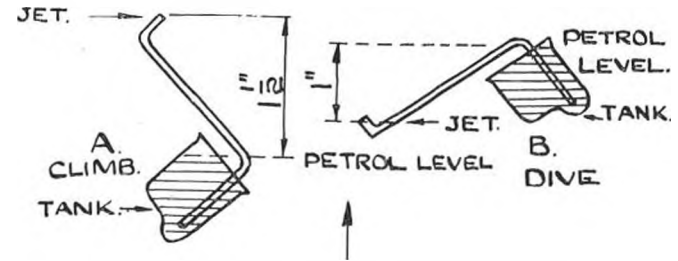

A & B ILLUSTRATE LARGE VARIATION IN PETROL LEVEL WHEN A MODEL IS DIVING AND WHEN CLIMBING IF THE JET IS A LONG DISTANCE FROM THE TANK. THIS IS ACCENTUATED BY FITTING A DEEP TANK. THEREFORE FIT A SMALL SHALLOW TANK AND THE JET CLOSE TO THE TANK.

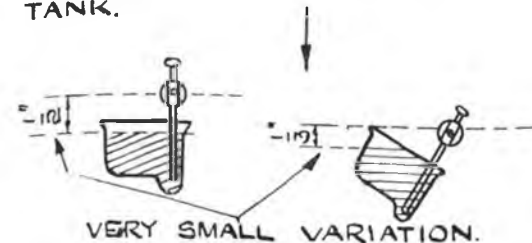

points designed in this way. Enclosed points are generally a nuisance, as one should be able to clean them quickly and check up on the contact-breaker points. Theoretically, enclosed points should keep out grit and dirt. In practice they seldom do. Dr. Forster, in his excellent book on "Petrol Engines for Model Aircraft," suggests a design of contact-breaker that might very well solve the oily points difficulty. Mr. Sparey has recently designed a novel engine with many excellent attributes that has a contact breaker with its points out of the way of oil.

(IV) Controls

Most model engines have the ignition control placed far too close to the revolving propeller. It is not difficult to design a simple and light remote control.

The induction pipe opening must be where it can be easily choked, and the petrol needle valve must be easily "getatable" and *not alter its setting by vibration*. Experience with a large number of engines will make one realise that these desirable, and, in fact, necessary, features are not often all combined on any one engine.

(V) Real "First Swing" Starting

Some engines are far better starters than others, but unfortunately far too many engines cannot be called "first swing" starters. Designers should concentrate on this feature of starting. It makes or mars the owner's flying time. "Starters back" has been very prevalent amongst petrol model enthusiasts in the past! Sufficient length of induction pipe is an important point in this respect in order to obtain a good column of air past the jet, a point that I have already remarked upon.

Engine Operation

It is not necessary to explain to the mechanically-minded how to start and operate the baby two-stroke

engine, but for the novice a few simple hints may assist.

The two-stroke is a very simple type, and, provided the engine is in good order—the ignition coil and wiring are good—and the ignition points and the sparking plug

FIG. 19.

IMPROVEMENTS TO A 3 PORT DIRECT INDUCTION ENGINE.

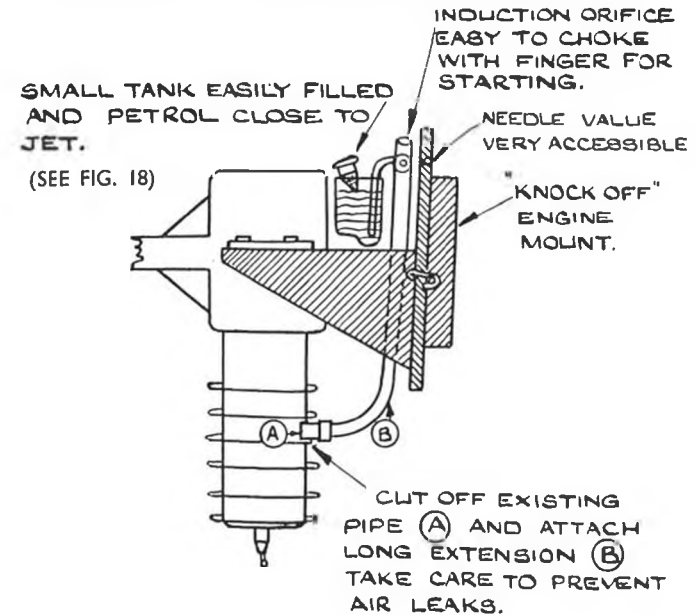

A LONG INDUCTION PIPE PROMOTES STEADY RUNNING AND POWER OUTPUT. THE ABOVE SKETCH SHOWS HOW A 3 PORT DIRECT INDUCTION TWO STROKE CAN BE MODIFIED AND MOUNTED ON A "KNOCK OFF" MOUNTING OF ELEKTRON.

are kept clean, there is little else to worry about than the correct mixture of oil and petrol and the cleanliness of the mixture.

It is very important that the correct grade of oil, and the correct amount should be used. The average mixture is 1 part of oil to 3 parts petrol. If this is varied, not only may the lubrication be faulty, but in many engines the actual running will be uneven, because the needle valve in these cases is rather coarse and the correct balance of oil in the petrol is required to give an even explosive charge. A medicine bottle, with its tablespoon markings, makes an excellent measure and mixing receptacle. For the field, a simple pourer can be made from an empty "Dettol" bottle with its screw-on metal top. Through this top a thin piece of brass tubing can be soldered. The tube should go nearly to the bottom of the bottle and the brass power tube can be soldered into the metal top as well. See Fig. 20.

To Obtain a Start

We must ensure that there is a good fat spark, and we must also be certain that the needle valve is opened the correct amount and quite clear. The needle valve can be kept open at the best running position, and on some engines a slight "doping" with a drop or two of mixture from the dope can put into the induction pipe will obtain a start.

On others it is merely necessary to choke the induction pipe with the finger for a few suck-in revolutions. After the engine has started, and as it clears itself of its rich starting mixture and good two-stroking sets in, a slight adjustment can be made to the needle valve so that maximum revolutions are obtained. Then give a final adjustment so that the mixture is just a shade rich before the model takes off. This will help to prevent starving

as the petrol level in the tank drops. (See my previous remarks on shallow and correctly-placed tanks.)

Although it is bad practice to fit gravity feed, i.e. the tank higher than the needle valve unless a float chamber is fitted, some people will continue to do so. In this case, after a few suck-in revolutions of the engine have been

FIG 20
A FIELD PETROL CONTAINER AND MIXER
FROM A "DETTOL" BOTTLE

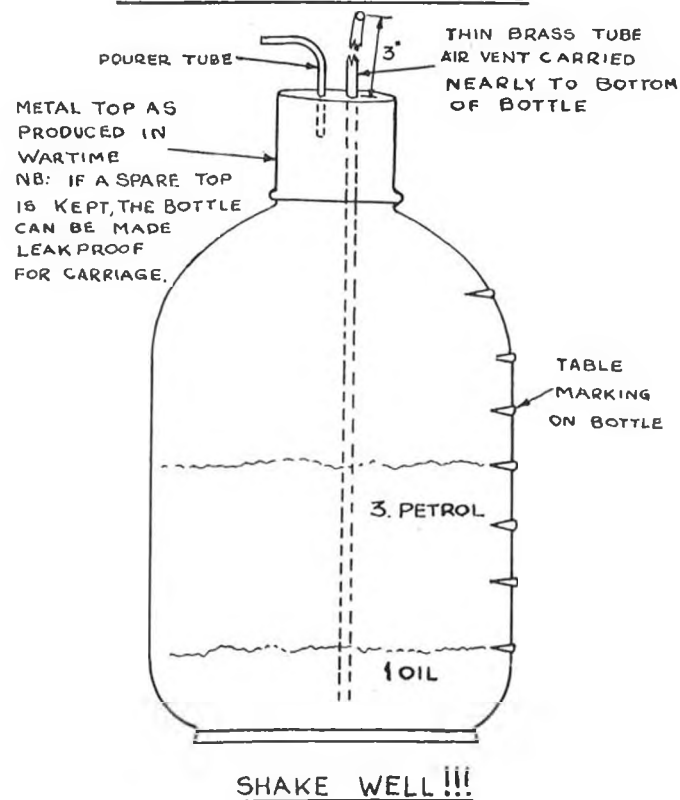

made with the needle valve open, the valve should then be shut, ignition switched on, and the engine started and allowed to clear itself of surplus fuel. The valve is then opened up gradually. If the valve is not shut off as suggested, the engine will often become swamped, due to the gravity-fed petrol flow. If difficult starting takes place, suspect the ignition. Check up that you have a good hot spark.

If the engine is in good mechanical order and there is a good hot spark, and the mixture is getting there, theoretically the engine must go! Sometimes one may get a good spark from the plug out in the open air, and yet under compression the plug's insulation breaks down. Therefore, if all *appears* to be well, and yet the engine will not start, try a new plug.

Swing the propeller *smartly*.

Do not waste time and effort by swinging away if you are not absolutely certain that there is a good hot, fat, spark every revolution and that the needle valve is clear.

Make sure that the ignition is not too far advanced. Also make sure that the ignition lever and the throttle do not move through vibration when the engine is running.

If the engine sucks in too much petrol and becomes choked, take out the plug and clean and dry it, close the jet and turn the engine over a number of times to clear the petrol. Replace plug and start up. When an engine four-strokes or eight-strokes, the mixture is generally too rich.

Decarbonisation

Some individuals are always taking their engines down to "decoke" them. My advice is "*let it alone.*" A two-stroke likes to be slightly carboned up. The carbon helps to make a good gas seal, and the success of a two-stroke largely depends on having no air leaks and on there being

good gas seals. The average model engine is worn out before it requires decarbonisation.

Of course, if the engine gets grit into it after a crash or if there is something mechanically wrong, then it must be taken down and cleaned out or otherwise attended to.

Running-in an Engine

Whilst the model is being built, the new engine should be carefully run-in, so that it gives its best performance when the model is ready to fly. During this running-in

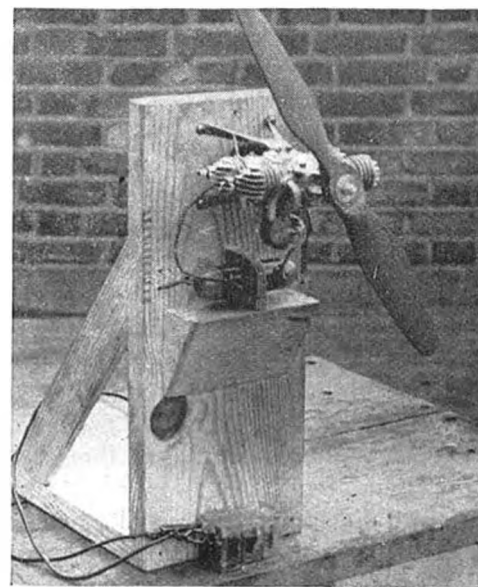

Fig. 21. The portable running-in stand as used by the author. A 4-cylinder "Elf" can be seen on this stand with its special spider mounting. (Note the baby accumulator.) Other stands have a square cut in them for the detachable Elektron engine mounts to fit into. The motor-cycle accumulator for starting is placed on the platform at the rear.

period the owner will become thoroughly familiar with the engine's controls and idiosyncrasies. I recommend strongly, therefore, that the reader constructs the simple running-in stand shown in Fig. 21, and takes his running-in seriously. It will make all the difference to the engine's life and also to the successful flying of the model aeroplane when it is completed.

Miniature Compression-Ignition Engine

We have heard a great deal recently about the little "foreign diesels." The Italians, the French, the Swiss, and the Germans have been busy on them during the war and they range from about $\frac{1}{2}$ c.c. to 10 c.c., and they work very well, too. I have a German 6 c.c. diesel to experiment with which Brigadier Parham, a fellow enthusiast, procured just after the collapse of Germany. It is a commercial job and is very well made, like most German mechanical things. This little engine was used to train Nazi youth. It will now be used for better and brighter things! The engine has several interesting points that I feel sure will intrigue those who see in the diesel a useful model engine of the future, chiefly because it is so simple and eliminates the electrical ignition complications of the baby petrol engine.

As far as I am concerned, I shall still use petrol engines, as there are many advantages; but there will also be diesels in my stable, too! I can well see their particular advantages for the powered model flying-boat and float-plane, two types that I have experimented with a great deal. As everyone knows, the ignition electrical gear on a petrol model is an infernal nuisance when there is water about. This is particularly true when there is sea-water around one, and also when attempting to launch a model flying-boat from a full-sized boat with booster batteries and long plug-in leads festooning around the operator.

One of the troubles of a model diesel is how to stop it after a given time in the air, because we have no convenient electrical ignition to cut by means of a timer and switch. The German that I have has solved this problem in a very simple and ingenious manner. A glance at Fig. 21B will explain the idea pictorially. The scheme is to get an ordinary "timer" to operate the simple gadget shown. A small hole is opened below the normal model-type of fuel needle-valve; air is then sucked in and destroys the suction on the fuel. The engine stops. My readers will find it more simple to study Fig. 21B than to read through a long-winded explanation. "E," in the diagram, is the spring-wire catch holding back horizontal tube "A" mounted on sleeve "B," which rotates on fuel pipe. When timer releases "E," tube "A" with "B" are rotated to stop "D" by coil spring "C," which causes the inner end of the tube "A" to register with a corresponding hole in the fuel pipe, which is normally covered by "B," thus allowing admission of air and thereby destroying the suction. The idea, or an adaptation of it, as shown, can be applied to any model diesel, and we need not worry any more about how to stop the engine at any predetermined time.

I make rather a song about this matter, as I notice that there is no provision to stop by "timer" most of the French, Swiss, and Italian engines, and it is obvious that in this densely-populated country we aeromodelists will soon become very unpopular if we fly our powered models away into strange gardens. An Englishman's house is his castle, etc., and he does not like strange appliances, aerial or otherwise, arriving uninvited. Neither can the rambling pedestrian, who does not happen to be a happy modeller, be expected to appreciate a screaming diesel-engined model whizzing by his ear, when going about his lawful occasions.

These *model* C.I. engines cut out all the bother about injection of fuel. They "cheat" by using ether in the fuel to lower the "flash point." They are in the form of strengthened-up model two-strokes with ordinary

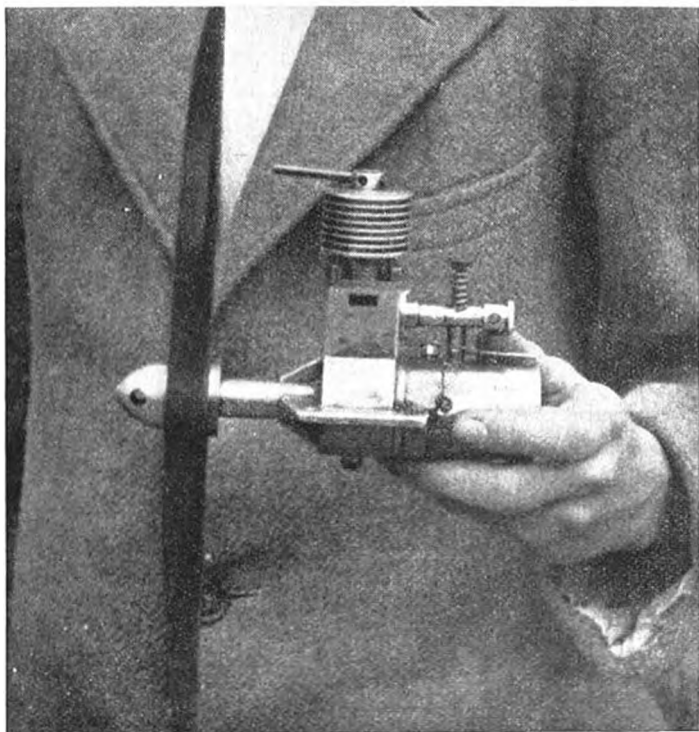

Fig. 21A. The German Eisfeld compression-ignition engine shown diagrammatically in Fig. 21B.

porting. The reason for their strengthening up is that a compression ratio of about 16 to 1 is used, which is, of course, far more hefty than the average petrol two-stroke compression of about 5 or 6 to 1. If a petrol compression ratio of only 6 to 1 were to be used, the mixture would

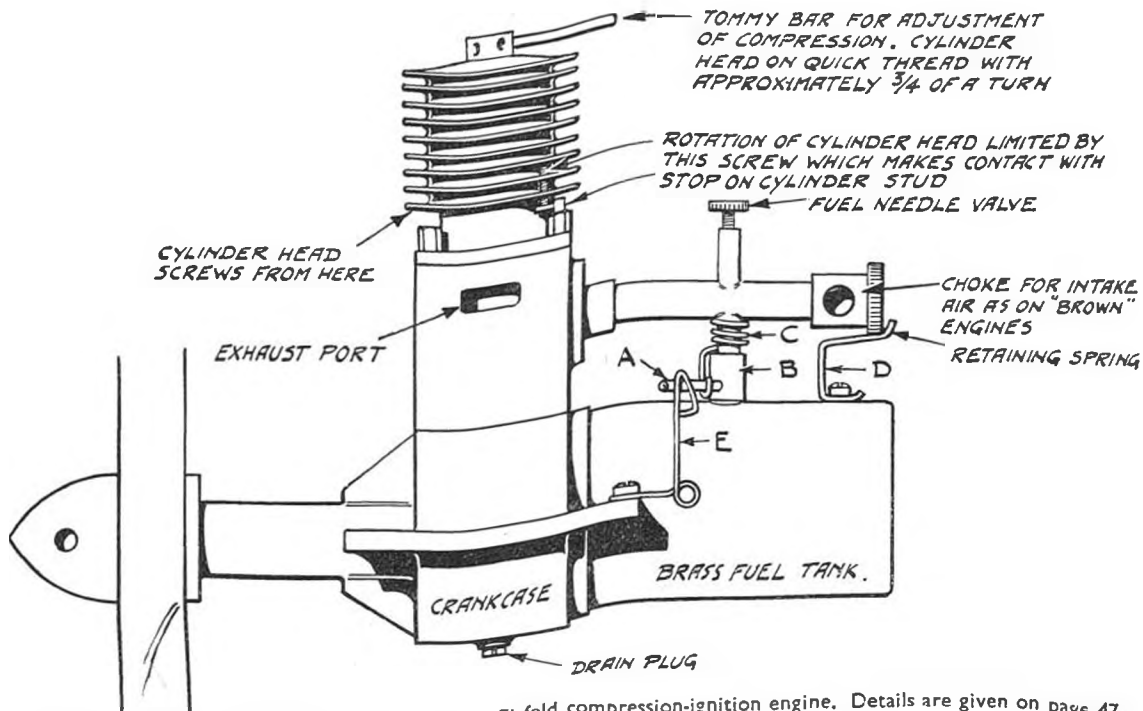

Fig. 21B. Diagrammatic drawing of the German Eisfeld compression-ignition engine. Details are given on page 47.

not be heated up sufficiently to create spontaneous combustion without an electrical spark.

As the model diesel (I am going to call them diesels, as it is a more convenient term than C.I. engine) does not obtain its timing by injecting fuel at a predetermined moment, it will be appreciated that the *mixture* must be just in the right proportions so that it explodes when the piston is at the top of the cylinder and the compression is greatest. We therefore have to be very careful about this mixture of fuel and the compression ratio.

One can mix up a "petroil" mixture and leave it for a deuce of a time, and yet it will function quite well. There was an authentic case of a two-stroke motor-cycle during the war that had a "petroil" mixture left in its tanks for several years, and yet it started up and ran perfectly at the end of the period. I have often left my model "petroil" mixture for months in the back of the car in its container and then used it with no trouble. In the case of the diesel "petroil" mixture the ether content means that it must be carefully corked in a bottle.

The model diesel engine may kick back seriously if started when warm, due to the lack of precise mechanical injection and people should be wary of them on this point. It is quite a good plan to fit a spinner in front of the propeller with a groove in it to take a starting-up cord—one can then start the engine in the same way as one does a model boat engine or model race car. Alternatively, one should wear a nice fat glove on the starting hand.

It is well-worth understanding what "diesel-knock" is, because if we know the cause we shall treat our engines with greater sympathy and common sense. It is very easy to obtain this knock if the compression is raised too much.

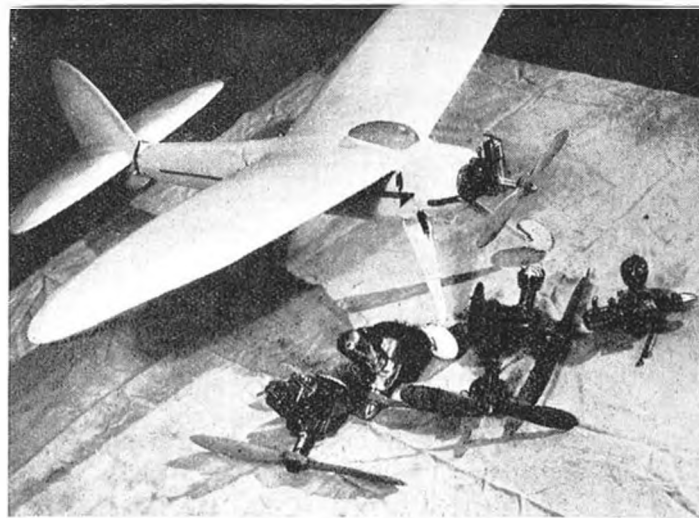

Fig. 21C.

Mr. Ricardo, who, of course, is one of the leading authorities on combustion-head design, found quite early in his researches, that diesel-knock was dependent on the rate of pressure rise per degree of crankshaft movement. If the pressure rise, for the sake of example, starts to take place on the first one degree of movement of the crankshaft, there comes a period when the rate of pressure rise is too great for the structure of the engine. *The knock then comes from the whole structure of the engine, which is taking the strain.*

This is not what is known as "pinkling." It is a noise of *shock* from the whole engine structure. That is why the diesel has to be built so heavily for its c.c. An amateur constructor of model C.I. engines should build robustly, and not attempt to use the same construction as in the model petrol engine of similar capacity and far lower compression ratio.

It will be evident also that a model diesel must have a good fit between piston and cylinder to keep the gas seal at the high compression ratio necessary to cause ignition.

The model diesel, like its full-sized brother, has a large power output at low speeds. This means that the diesel will turn a larger propeller at lower revolutions than the model petrol engine. This is a considerable advantage.

The author's summary of diesel running instructions that suit most British or Continental diesel engines, except where makers give special instructions.

1. *Fuel*—Take a measure of a suitable size. The following mixture should be *carefully* made.
 - 1 *Measure*. Castrol XXI motor car lubricating oil. *No other oil of a lighter grade should be used.*
 - 2 *Measures*. Ether (from chemist).
 - 2 *Measures*. Diesel fuel oil, as used for fuel or diesel lorries. Obtainable from garage.
 If special "Mills" model diesel fuel is available, mix in the following proportions :
 - 1 *Measure*. "Mills" fuel.
 - 1 *Measure*. Ether.
2. *Carburettor Setting*—As sent out by maker. If this is lost, open fuel needle valve one turn and suck in by swinging several times with finger over the induction pipe. Then swing to start and adjust to suit two stroking when started.
3. *Compression Adjustment*—Most diesels are now fitted with a contra piston in the top of the cylinder (knob) that can be screwed up or down to vary the compression. Screw the knob to the right and the contra piston goes down and raises the compression and *vice versa*.

To start, usually increase compression by screwing knob clockwise $\frac{1}{4}$ to $\frac{1}{2}$ turn. When engine starts, return

the knob to running setting by screwing back until engine runs at greater power. The carburettor needle valve may also have to be adjusted to suit. Once these settings are found, they do not vary on good model diesels.

If engine becomes difficult to swing, *i.e.*, "hard," it has sucked up too much liquid fuel and trapped this between the piston head and the cylinder top, as there is little space on these high-compression engines and the liquid cannot be compressed. Therefore slack off the compression adjusting knob a turn or two, turn over the engine until free, return the adjusting knob to the normal starting position, and swing to start.

CHAPTER IV

THE IGNITION SYSTEM AND CONTROL OF FLIGHT DURATION.
A BATTERY AND TIMESWITCH CARRIER*The Ignition System*

THERE are two systems that may be used on the model petrol aero engine : the magneto or the coil and battery. The magneto has not often been used, chiefly because it is difficult to make a flywheel magneto small enough and light enough to suit the smaller types of aero engine. Mr. E. T. Westbury made a successful flywheel magneto in the early days of the petrol model aeroplane and fitted it to his 52-c.c. engine, whilst Mr. Rankine, the well-known model speed boat enthusiast, has produced a number of highly successful flywheel magnetos for his 30-c.c. racing boat engines.

The magneto ignition system is a very attractive proposition, as it eliminates troublesome wiring and spare flight batteries and also the necessity for transporting booster starting batteries. Perhaps in the future, with recent advances in suitable light-weight alloys that have been developed during the war, we shall see a baby flywheel magneto. It is one of the experiments in which I am interested.

Recent experiments by Mr. Westbury and others have done much to solve the problem of light-weight magneto design and construction and, at the moment of going to press, reports have been received of a successful magneto weighing only 8 ozs. and applicable to practically any type of model petrol engine. This magneto is not of the flywheel type, but the design is adaptable either to

construction as an integral part of the engine or a separate unit.

No magneto sufficiently small and light for model aircraft engines has yet been produced commercially, however, and the battery-coil system is universally employed on existing manufactured engines.

Ignition Coil Design

The production of ignition equipment is a highly specialised department of electrical engineering, and the smaller the apparatus, the greater are the practical problems involved. Up to the present, very few users of these small engines have attempted to construct their own ignition coils, but during the war the impossibility of obtaining ready-made equipment has focussed attention on these problems and, thanks to a systematic investigation of the entire subject of ignition from the model engineering aspect published in *The Model Engineer*, many aero-modellers have been able to tackle light-weight coil construction with success. Details of the processes involved are beyond the scope of this book, but it may be mentioned that the principal difficulty in the actual construction consists in concentrating a fine winding of several thousand turns of wire, with adequate insulation, into a very small bulk and weight ; while very careful design and experiment are called for to ensure that the tiny coils work with an efficiency comparable with that obtained in full-size practice.

The modern model aero engine usually ranges from $1\frac{1}{2}$ c.c. to 9 c.c., and in these sizes the baby coil and battery can be commercially produced reasonably light and quite cheaply. As a result, it is the standard commercially-produced form of ignition for model engines.

This being so, we will discuss its installation and wiring circuit in this chapter.

The Weight Factor

At present we have to face a certain minimum weight if we are to obtain reliable ignition. Although slightly lighter coils have been produced, the average reliable light-weight coil weighs $1\frac{3}{4}$ ozs. To this we have to add $\frac{1}{2}$ oz. for wiring, 4 ozs. for flight battery, $1\frac{1}{2}$ ozs. for flight timer to switch off the ignition at a pre-determined time, condenser $\frac{1}{2}$ oz. ; a total of 9 ozs. The ignition therefore weighs more than the average 9-c.c. engine !

This is not excessive, perhaps, when we use a 9-c.c. or even a 4-c.c. engine, but it is undesirably heavy for the little $1\frac{1}{2}$ - to $2\frac{1}{2}$ -c.c. engines. We can use a baby accumulator weighing from $1\frac{3}{4}$ to $2\frac{1}{2}$ ozs. and make a slight saving in weight—but more of that anon.

The Flight Battery

The Americans often use very small "Pencil" flash-lamp batteries, but the British types are not very successful in our cold climate and, after many experiments, I have come to the conclusion that with existing coils the 4-volt 4-oz. flash-lamp battery is the lightest practical dry battery for flight. Even this type of battery will have to be changed frequently between flights, and several absolutely fresh new batteries must be taken with one for a day's reliable flying. It is not always appreciated that the power output of most model petrol engines is very much affected by the intensity of the spark at the sparking plug. To obtain this powerful spark that will cause really efficient combustion we must provide sufficient electrical energy. Recently even smaller and lighter coils have been specially developed for use with the very tiny engines of $1\frac{1}{2}$ c.c. These coils do operate successfully on 3-volt "penlight" batteries. In fact they seriously overheat on 6-volt or even 4-volts.

The Baby Accumulator

Both Dr. Forster and I were perhaps among the first to experiment with baby accumulators for model aircraft and we are satisfied that it is quite feasible to use a 4-volt $2\frac{1}{2}$ -oz. lead-acid accumulator which can be charged from a 6-volt booster accumulator. (Motor-cycle type).

Mr. Norman has recently flown a baby model of only 31 in. span with a baby accumulator weighing only $1\frac{1}{3}$ ozs. for ignition. (See Fig. 22.)

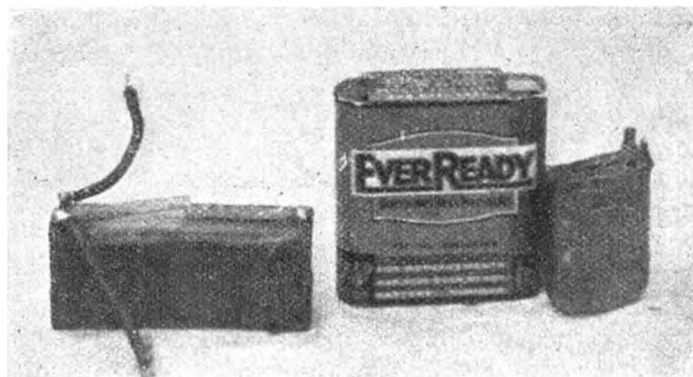

Fig. 22. Dr. Forster's mini accumulator is seen on the left, and Mr. Norman's $1\frac{1}{3}$ oz. on the right of the standard 4 oz flash-lamp battery that is the best alternative.

These really baby accumulators weigh less and they are far more efficient than a dry flash-lamp battery, because the internal resistance of an accumulator is much lower, and its current output, whilst the charge lasts, is far greater. A much hotter spark is therefore provided by the coil, with the result that the engine runs better if the mixture is not quite correct. It is often, however, more convenient to use a 4-oz. 4-volt flash-lamp battery.

The baby accumulator can be charged slowly by a trickle charger before the day's flying takes place, and then a half-minute charge from the booster accumulator

on the flying field, between flights, will ensure first-class flying. The method and chief points of most accumulator construction are given in Fig. 23. One of the great troubles of these little accumulators is leakage of electrolyte between cells. This is best overcome by moulding two half cases and gluing these on to a central sheet of celluloid.

Experience has brought to light that certain constructional features make all the difference between success and only partial success in these accumulators. The main troubles are internal shorting by the sludge which drops from the plates and also the internal leaks between cells already mentioned. The plates should be cut from *new* plates if real success is desired. Dr. Forster has really got down to the requirements of a model accumulator for flying purposes, and the details given in Fig. 23 are largely the result of his experience.

Baby Accumulator Maintenance Notes

The end of the accumulator shown in the sketch (Fig. 23) should be tipped up with the anti-spill guards uppermost. Electrolyte drawn from a full-sized accumulator can then be inserted by a fountain-pen filler into the holes, so that the maximum level is as shown in the sketch. As the electrolyte is pumped in, the air displaced escapes from the small hole covered by the pointed end of the guard.

After the plates have soaked up the electrolyte, put in a little more to bring up to the level mentioned above. Now place the battery on a gentle trickle charge, or in series with a 2.5-volt bulb for two or three hours. Never flash-charge direct from a 6-volt accumulator for more than a minute. Even less is better. *Do not leave in a discharged state at the end of a day's flying.*

It is essential to keep the two 4-volt terminals from being shorted outside the cells by acid. This is why the

guards open away from the terminals. Recently the famous NIFE Battery firm put on the market an accumulator of 2 volts, which, owing to its efficiency, will start up a model engine without the aid of a booster battery,

FIG. 23.

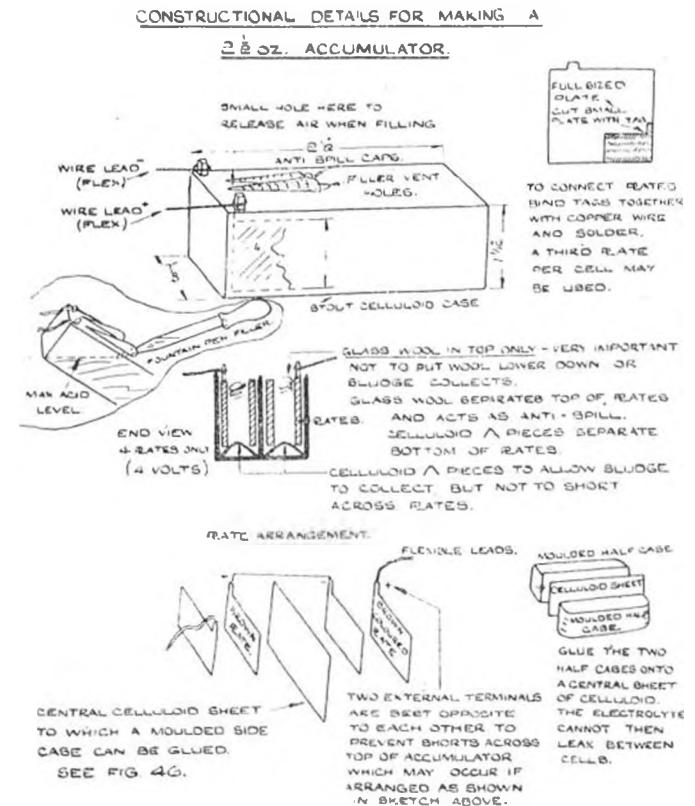

and can be used for flying large models. The weight is unfortunately 8 oz. But the firm hope to reduce this by fitting a plastic case in place of the steel one now fitted.

I have used these little accumulators with great success

on large 8-ft. span models. The NIFE accumulator is practically indestructible, and is not damaged by neglect, shorting or overcharging. When we get down to the 5 oz. expected, these accumulators will be the answer for models of 5-ft. 6-in. span and upwards.

The Booster Accumulator and Method of Starting Up an Engine

Some aero-modellists use large dry batteries as a booster battery for starting up and running up prior to flight. I used these in the early days, but have forsaken them for the motor-cycle type 6-volt accumulator. The accumulator is far cheaper in the long run and much more reliable, and it must not be forgotten that the flight battery is generally 4 or 4½ volts. If a 4-volt battery or baby accumulator is used in circuit with a 4-volt booster, the smaller sized flight battery, or accumulator, will discharge itself into the larger capacity booster if left in circuit.

It is therefore highly desirable when using a 6-volt accumulator (motor-cycle type) as a booster to use only 4 volts, and provided the booster is not left plugged in and with the ignition points closed, the coil will not be overheated or damaged. Always make a point of either switching off, or pulling out the plugs when not actually running the engine on the ground. Fig. 24 shows a suitable ignition wiring circuit.

The procedure for starting up a model aero engine on the ground is as follows :—

The flight battery (or accumulator) is placed in position and connections checked. The flight-timer switch is off. The booster accumulator plugs are plugged into their sockets, marked red for + and black for —.

The engine is then doped, or choked as required, and smartly swung until a start is obtained. The engine is warmed up, and even two-stroking is obtained by adjustment of the mixture valve, if it is a two-stroke, and final

adjustment of the ignition advance and retard lever. Advance for speed and retard to slow down engine.

The flight-timer switch is now set into operation, and the flight battery becomes in circuit.

The booster accumulator plugs are removed and the model is released. It is advisable to set the mixture just a shade on the rich side before releasing the model.

With suction feed, particularly in the case of smaller

FIG. 24
IGNITION CIRCUIT & WIRING.

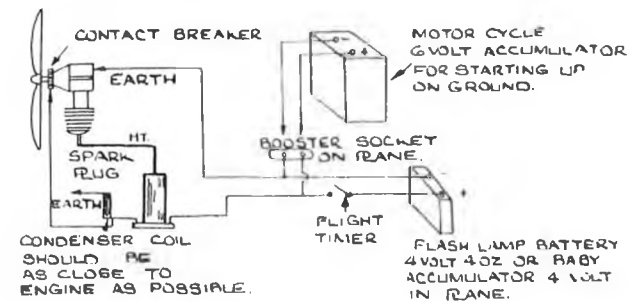

KEEP WIRING SHORT & ALL JOINTS SOLDERED
USE RED INSULATED WIRE ON THE POSITIVE SIDE (+)
USE BLACK ON THE NEGATIVE SIDE (-).
THIS MAKES IDENTIFICATION EASY & ELIMINATES MISTAKES.

engines, on many of which the induction pipe is of little less diameter than that fitted to larger capacity engines of 6-c.c. and over, the act of flicking the airscrew over by hand, is often not sufficient to suck up enough fuel to make a mixture. In the smaller capacity engines, therefore, it is often necessary to introduce a few drops of fuel into the induction port in order to obtain a start. Beware, however, of flooding the engine.

Personally, I carry my motor-cycle booster accumulator in a wooden carrier with a handle. Two long flexible leads are attached to the accumulator and have pl¹

fitted at the ends that plug into the sockets built into my models. My booster carrier box is made sufficiently large to carry spare parts and tools as well as the booster accumulator. See Fig. 25.

When a baby accumulator is used for flight ignition, it is advisable to line the battery carrier with sheet celluloid, or if the accumulator is kept in the fuselage, a sheet celluloid case can be built into the fuselage. This prevents damage due to acid leakage or spillage. Acid rots balsa wood, and corrodes metal. "Crocodile" clips are not suitable connections on baby accumulators owing to the corrosion that takes place. This quickly eats away the little lead accumulator connection stub. It is better to solder flexible wire leads to the accumulator stub, and connect these to the coil by twisting the wires. The wires *must* be clean and good contact made.

The Sparking Plug

There are two sizes of sparking plug usually fitted to modern model engines: the $\frac{1}{4}$ -in. size is for the baby engine and the $\frac{3}{8}$ -in. size for the larger engine. Sparking plugs must be kept clean and the electrodes kept at the correct gap. Owing to their small size and the oily mixtures that are used, the internal insulation easily breaks down. If cleaning will not rectify, change to a new plug.

A Carrier for the Battery and Flight Timer

Between each flight it is advisable to check up battery connections (usually in the form of crocodile clips for large models when a dry flash-lamp battery is fitted), and it is often necessary to change the flight battery itself. It is therefore highly desirable to place the flight battery where it can be easily got at. I have tried all methods of battery mounting and now usually sling the flight battery ^{is} ~~me~~ a dummy radiator or container below the fuselage in

the case of a high wing or below the wing in the case of a low-wing model. The carrier can be kept in position by rubber bands. It is therefore quickly detachable and it absorbs shock in the event of a crash. A heavy battery may do a lot of damage in a crash landing if it is inside

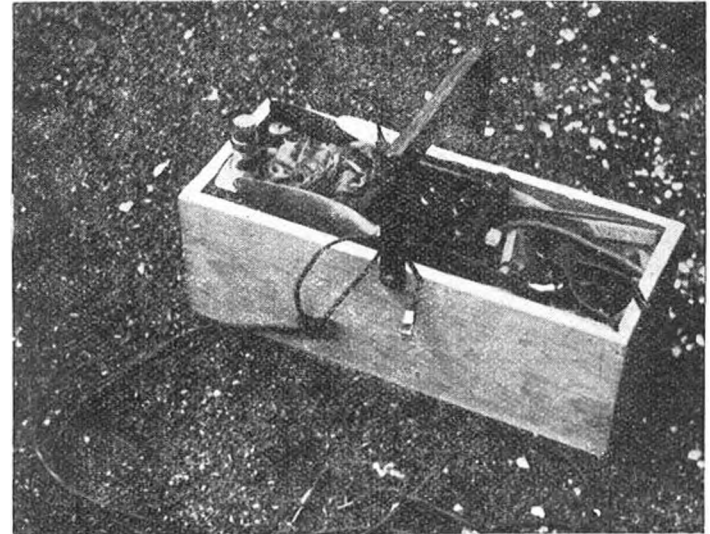

Fig. 25. The author's booster battery and tool carrier.

the fuselage. The external battery carrier can also be moved along the fuselage during the preliminary gliding tests until the C.G. is in exactly the right spot. Its position can then be marked and hooks provided for the rubber retaining bands at this position.

Fig. 26 shows a dummy Lamblin-type radiator with its hooks for rubber bands and a flash-lamp battery pushed into its recess. In this case I have mounted a 6-min. clock in the front end for flight-time control. I also mount the coil in this carrier. I therefore now have all the "electrics" except the condenser in one detachable "radiator."

I can thus change the carrier with its clock-timing mechanism and coil from one model to another. The dark patch shown at the nose is a dummy radiator grill, meant to represent the cooling gills of a radiator. On the other side are mounted the two booster plugs. The aeromodeller can make up a really nice-looking radiator on these lines. The example I show is severely plain and has no frills. It is constructed from sheet balsa. This carrier can be changed from one model to another, thus economising in coils and timers. The radiator can also be used for running-in engines on the bench.

The Wiring Diagram

All wiring should be kept as short and simple as possible and joints must be soldered. Insulation must be kept perfect. Half measures will not do *and will be the cause of endless trouble*. In fact, faulty and careless wiring

Fig. 26. The author's dummy Lamblin radiator slung below the fuselage. It contains a six-minute time clock, the coil, and a flash-lamp flight battery. The battery and clock are clearly shown. The booster plugs are on the other side.

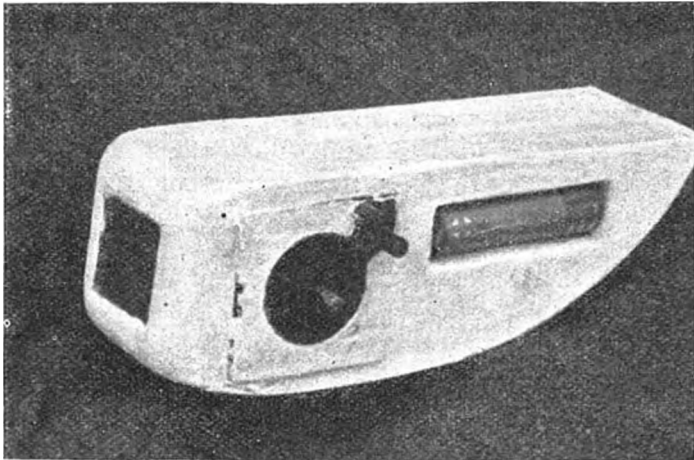
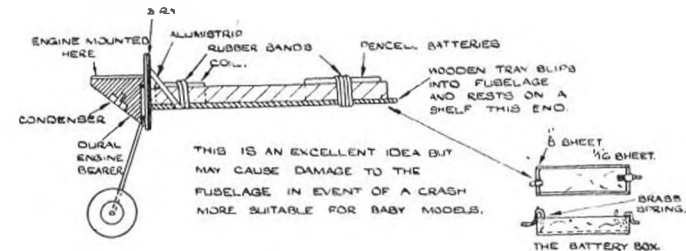

FIG. 27.

AN AMERICAN METHOD OF MOUNTING ENGINE AND ITS ELECTRICAL IGNITION GEAR.



is the greatest cause of failure on the field in the petrol model aeroplane. (Refer back to Fig. 24.)

Installing the Condenser, Coil and Flight Battery

The Americans often mount their coil and battery on a carrier, as shown in Fig. 27. This carrier, or tray, pushes into the nose of the model and is secured at the rear end by a shelf or wire loop.

On the front side of the carrier is mounted the detachable nose-former with simple wire undercarriage legs and the engine. This method has certain advantages for light models, e.g. the whole wiring can be taken out quickly with the engine. The battery and coil can be slid along the internal carrier to change the trim. Its major disadvantage is that in the event of a crash the engine and the carrier behind it are too rigid and may sweep away a portion of the fuselage side, bottom or top.

From long personal experience, I prefer to have a detachable engine mount, as described in Chapter III. This allows the engine to be knocked off without damage. One can then either secure the coil in the fuselage or in the detachable carrier already described.

Some people mount their battery on an adjustable slide inside the fuselage ; access can be gained either by

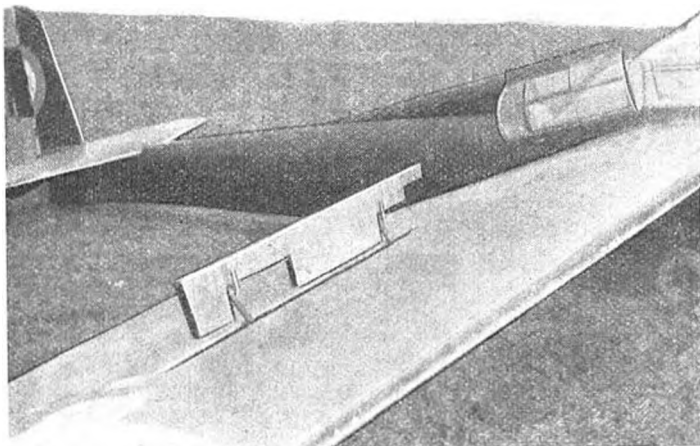

Fig. 27A. These "spoiler" panels are raised on this German full-sized sailplane wing to reduce the glide. A similar idea can be used for petrol models to prevent soaring away in a thermal, and the loss of a model. The panel can be operated by a time-switch.

taking the wing off if the model is a high wing and uncovering a trap door or by opening a trap door below the fuselage. The first method is a nuisance between each flight, when one should check up the battery connections, whilst the second method may weaken the fuselage because of the trap door. The second method is far preferable in practice to the first. In this case the battery can be moved along a slide to adjust the G.G. position of the model.

In a biplane, the battery can be carried in the centre section at the bottom of the plane. See Fig. 28.

Points to Remember

- (a) Keep your wiring as short as possible and do not use very thin, flimsy wire.
- (b) Keep insulation good.

- (c) Solder all joints carefully.
- (d) Mount the condenser as close to the ignition points as possible. *A matched condenser for the coil should be used.*
- (e) Sparking plugs must be kept clean and in good condition.
- (f) Absolutely fresh batteries must be used.
- (g) Ignition points on the contact breaker must be kept clean and properly adjusted with a good, strong contact-breaker spring. Points must meet squarely over their full area or sparking and pitting will result. A good, strong spring on the contact breaker is necessary, as points have to operate 66 times per sec. at 4,000 r.p.m., which is quite a normal speed for modern model aero

Fig. 28. The author's simple battery carrier in the lower wing of a baby model bi-plane, which has no timer and relies upon a very small petrol tank to control duration of flight.

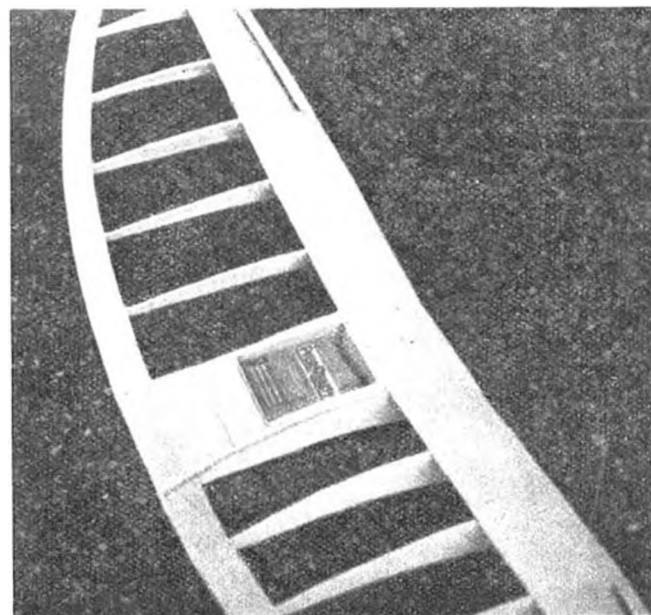

engines. Engine performance may sometimes be improved by increasing the spring tension.

(h) Keep the coil away from oil. Do not mount the coil directly to a metal wall.

The Flight Timer

The petrol model aeroplane may become a danger unless some positive control to regulate duration of flight is used. This control must be accurate and reliable. To control duration by limiting the petrol supply is not usually sufficiently accurate unless the model is being flown over a large sheet of water or over a large uninhabited part of the country. Furthermore, it is possible to damage the coil if the engine happens to stop with the contact-breaker points closed.

The safest method of regulating duration of flight is automatically to cut the ignition circuit at some predetermined time. Even then a lightly-loaded model may soar like a sail plane, and take some considerable time to come down. Just prior to the war the Americans were using various devices to spoil the airflow and so reduce the glide. They called these devices dethermalisers, and they can be operated by a time-switch. German full-sized sailplanes use a similar device called "spoilers." See Fig. 27A.

If the model is fitted with a large engine, it is possible to throttle back first and later to switch off the ignition by means of time switches: this is the method I adopted on my early models. For the smaller type of engines, however, this method is not so practicable, as the small capacity engine will not idle. We must, therefore, rely upon an ignition time switch.

There are various types of "flight timers," as they are usually called, and I will give a short description of those that are most popular. If the reader will refer back to Fig. 24, showing the wiring circuit, he will see that the

time switch is fitted on the positive side between the booster plug and the small flight battery.

The "Majesco" timer is a very light tubular affair which works on the dashpot principle. It allows a gradual leak of air which eventually opens the points in contact, thus breaking the electrical circuit. The air leak is adjustable, and the predetermined time is fairly accurate. This type of switch is very light and reliable, but is not dead accurate for flying in confined areas. Dash-pot timers are often made by amateurs.

A simple time switch that I originally evolved can be made up from either a Kodak camera self-timer or an

FIG. 29.

A TIME SWITCH MADE UP FROM A KODAK
CAMERA SELF-TIMER

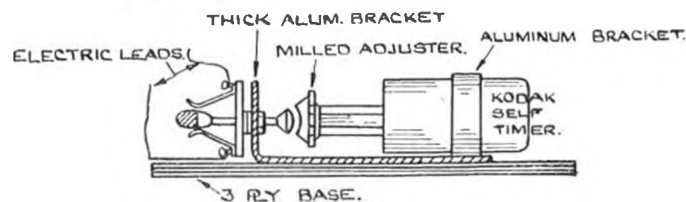

Autonips self-timer. Fig. 29 shows the details of the Kodak self-timer switch.

Little clock mechanisms can be bought in America and are often imported into this country. They are quite light and reasonably reliable. They suffer from the disadvantage of not having a second and minute dial and are, therefore, rather hit and miss. These clocklike timers can be obtained giving durations of from one minute to three, or even five, minutes. The mechanism is uncovered and inclined to be upset by dust, dirt and grit unless the aero-modellist makes a case. A good time switch can be made up from a cheap and small clock. For a number of

years I used a device of this nature, and it still works to-day, although made in 1934.

The best device I ever had was a special time switch somewhat on the lines of my early clock and made up to my special requirements by a firm of clockmakers in Birmingham. It weighs $3\frac{1}{2}$ ozs., which is rather heavy, but it is most reliable, and is calibrated from 10 sec. to 6 min. This clock can be seen fitted to my battery carrier in Fig. 26.

When I fly in certain rural districts where no damage can be done, I often dispense with a clock on the baby-type models, and use a baby petrol tank which limits the engine run to approximately $\frac{1}{2}$ min. Dr. Forster has evolved a reliable timer in which a small airscrew is operated by the slipstream. This baby propeller operates a small clock mechanism.

A method of controlling the length of flight when a diesel engine is installed is described in the previous chapter. Fig. 21B.

CHAPTER V

AUTOMATIC STABILITY AND DESIGN, INCLUDING NOTES ON SLOTS AND AIRFLOW

General—Automatic stability is the Keystone of the Petrol-driven Model Aeroplane

THERE are certain fundamentals in connection with stability that should be known by the aero-modellist in order to fly a model satisfactorily. He must also understand these facts before he can design a really successful and reliable flying model. As the subject is a large one and may become confusing, I propose to discuss the main facts only. Provided the novice understands these fundamentals, the subtleties will automatically present themselves as he gains experience.

Water and air are media which offer resistance to surfaces passed through or at an angle to them. This fact is used as the basis of design in connection with boats and aeroplanes. Water, of course, is a more dense medium, and therefore reaction of a similar degree will be obtained on a smaller surface. As a result of the lower density of air, an aeroplane requires greater surfaces to support, or move, a given weight than a boat, unless the aeroplane is flown at vastly greater speeds, which pile up the more loosely-packed molecules of the air. That is why a speed model aeroplane requires what is called a high wing loading, viz. a smaller area of wing and controlling surfaces for the weight of the machine. Every aeroplane has a point where all the resistance to the air on its different surfaces is greatest. This is called the "Centre of Resistance." See Fig. 30. This centre of resistance is

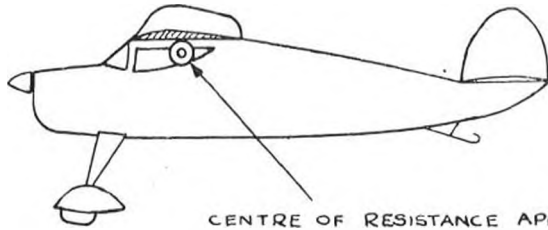
FIG 30THE CENTRE OF RESISTANCE

CENTRE OF RESISTANCE APPROX HERE
TAKE IN ACCOUNT RESISTANCE OF
FUSELAGE, UNDERCARRIAGE, WHEELS
AND DIHEDRALLED WING

very important in weighing up various design factors.

Although longitudinal, lateral and directional stability react upon each other, for the sake of simplicity, stability is best considered separately under three headings.

Longitudinal Stability

The first thing we want to obtain is slow flying for the general purpose petrol model, for this means that the model will land slowly, and in the event of a crash—or its flying into some object—the impact will be less.

To obtain slow flying, we must have a light wing loading, something between 8 ozs. to 14 ozs. per square foot. The nearer the loading is to the first figure, the easier the model will be to control and fly and the slower it will land.

If one wishes to fly constantly in windy weather, the wing loading may be higher, say, 16 ozs. per square foot, in order to obtain sufficient forward flying speed against the wind. If this wing loading is overdone, however, and

the model gets out of control on a down-wind turn, the best thing to do is to close one's eyes and block one's ears until the crash is over! For normal weather of light winds or calm air, keep the model a slow-flying machine with a light wing loading. It will be far safer and more enjoyable to fly.

Longitudinal stability means that the model will keep on a normal keel in a fore and aft direction, through the air pressure balancing the mainplane against the tailplane, and that varying speed and thrust of the engine does not upset this equilibrium. It is comparatively easy to obtain this longitudinal balance by setting the mainplane at a positive angle of incidence with the tailplane at a slight negative angle, or at no angle of incidence. This produces a longitudinal V angle between the mainplane and the tailplane, and so provides stability. See Figs. 31 and 32.

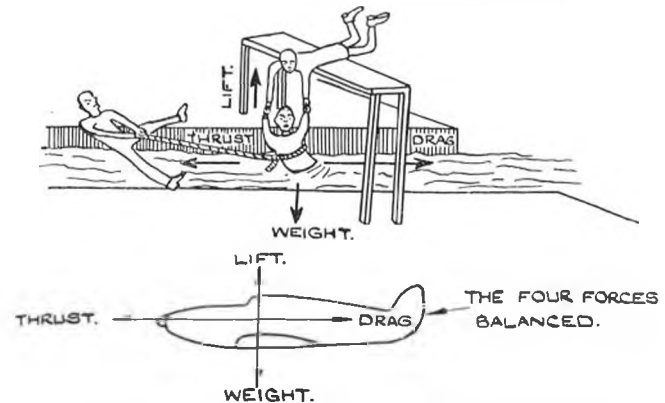
FIG 31.THE FOUR FORCES.

HOW FORCES BECOME UNBALANCED IS EXPLAINED IN
FIG. 33 AND THE TEXT.

The difficulties take place when the varying thrust of the engine enters into the problem, and it is this "thrust line" positioning and its effect that must be understood. Let us look at the drawing of a "parasol," a "high wing" and a "low wing" in Fig. 33 and see how the positioning of the engine thrust line alters the characteristics of the model.

Having studied Fig. 33, it is perhaps as well that I should make a few general observations.

The parasol and the high-wing models have one great advantage in common: the centre of gravity can be

FIG. 32.

THE LONGITUDINAL DIHEDRAL ANGLE.

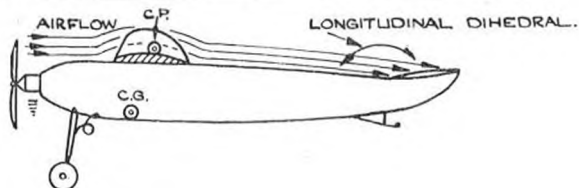

kept low, but to effect this the thrust line tends to pull the nose up and cause a stall when under power *if the model is rigged, as it must be, so that when the engine is off the model glides nicely.*

To overcome this nose-up tendency under power, we have to give what is called down thrust, i.e. we tilt the engine to pull slightly downwards. The higher the wing and the more powerful the engine, the greater must be the down thrust. Unfortunately, the thrust varies according to whether the engine is running fast or slowly, and therefore a compromise must be made.

A slightly lifting tail section will also help, and the mainplane should not be flown at too great an angle of incidence. The parasol and the very high-wing model is inclined to stall under power, but is stable on the glide,

FIG. 33

THRUST LINE EFFECTS AND TAIL PLANE SETTING.

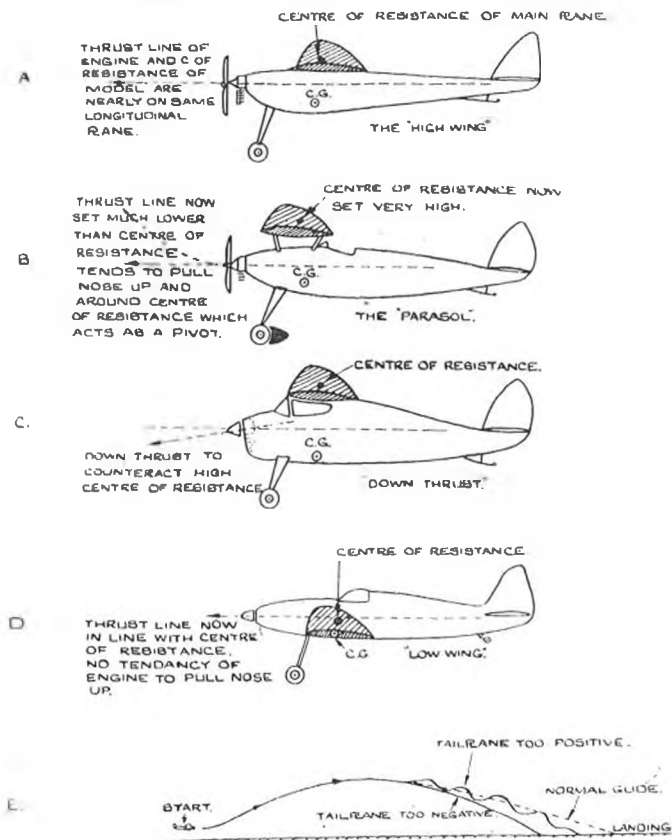

due to the weight being low and causing a good pendulum effect. It is a mistake to place the C.G. too low, as there is then a tendency to swing out too far on turns, due to centrifugal force.

In the case of the mid-wing model, only a little down thrust will be required, because the dihedral angle of the

mainplane will cause the centre of resistance to be only a little higher than the thrust line.

Contrary to popular belief, the low-wing model can be made a very stable machine, provided the weight is kept low in the design, so that the centre of gravity is not above the centre of resistance, because the thrust line can be made to go directly through the centre of resistance when one allows for the dihedral angle. A low-wing model will require a little more dihedral than a high-wing, and the weight can be kept low, to give a good pendulum effect, by slightly heavier wheels and undercarriage, also by positioning the coil and battery below the wing, as I have suggested in the previous chapter. I have found from experience that the tail should be positioned further from the mainplane in a low-wing model in order to evade the air disturbance of the wing, which causes buffeting and instability. If the model is a fast one, the wing should be faired into the fuselage by fillets.

Tailplanes can be divided into what is termed the "non-lifting tail and the lifting tail." The subject is rather complicated, but, very broadly speaking, the effect of the non-lifting tail can be seen by referring back to Fig. 32. It is a very safe type of tail to fit and the section is streamline.

On the other hand, if properly understood, the lifting tail is a most valuable type. This type has a top camber only, which acts in the same manner as the mainplane, i.e. it creates lift. (Lifting tailplanes should not have a deep camber.)

The lifting tail is then set at a lesser angle of incidence than the mainplane.

When the model is in level flight there is only a slight lift of the tailplane as it is flying at a lesser angle of incidence. The model may climb unduly, and then the mainplane will get into a stalling angle. The tail now flies at a greater angle of incidence and obtains more lift,

which pulls up the tail, due to its being at the end of a long moment arm, in the form of the fuselage. The stall is thus saved. Alternatively, when the flying speed of the model becomes great, the increased airflow and slipstream cause the tail, at the end of its long fuselage, to exert a considerable lift in an upward direction.

It will be realised that, provided a lifting tailplane is properly used, it permits of a very fast and steep climbing model and checks the stall. On the other hand, if the principle is not properly applied, it may cause considerable trouble. When a "lifting tail" is used, the C.G. will be further back, i.e. approximately three-quarters from the leading edge of the wing. A "non-lifting tail" requires the C.G. to be approximately one-third back from the leading edge. The C.G. position can be checked by balancing the model on the fingers and moving the wing into the correct position, as stated above.

Lateral Stability

The first important point is to locate the C.G. reasonably low in relation to the wing. A low C.G. gives a pendulum effect, and uses the centre of resistance of the wing to swing on. Lateral stability is obtained by a dihedral angle of the mainplane, *balanced by the correct sized fin aft*. Do not locate the C.G. too low, however.

A dihedral angle may be given to the wing as shown in Fig. 34 or a similar effect may be obtained by what is called polihedral, also shown in Fig. 34. The acute dihedral angle being further outboard has a long leverage and a very quick righting action. The polihedral is, therefore, exceptionally stable, but does not look so realistic. It is much favoured by American acro-modellists to overcome instability caused through fitting very high wings and over-powering their models.

A model may drop one wing, due to an air disturbance, and also, when the model turns, due to an offset fin, a

FIG 34

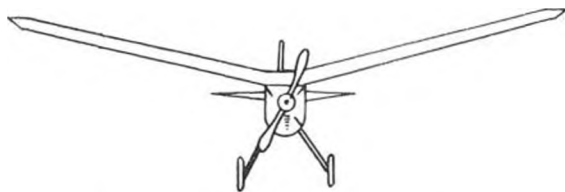
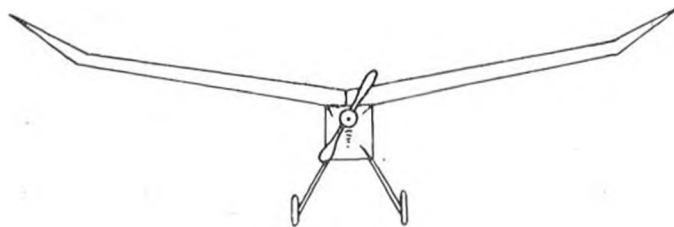
A DIHEDRAL ANGLED WINGA POLIDIHEDRAL *WING

warped wing or engine torque. The outside wing travels faster and thereby gains more lift. The model then banks over on to its side and begins to slide inwards and downwards unless something is done to prevent it. If the centre of gravity is below the centre of lateral area, as it should be, it will be appreciated that a push from a position above the C.G. position will send the model back on an even keel, as the C.G. is used as the lateral pivoting point. As the model is slipping downwards sideways (see Fig. 35), it strikes the resistance of air from the lower side, because it is slipping into it.

If we place two fins *that are situated above the C.G. pivotal point*, one at the nose and one at the stern, then the air

pressure will arrest the side-slip of the two fins, whilst the rest of the model will go on. The two fins will therefore push the model back on to an even keel. Instead of using a fin at the front end of the model, we make use of the mainplane, for, if we give it a dihedral angle (which is only a V angle), we have the same effect of side area above the C.G. as a fin.

It is quite possible to fly a machine with a sharply-dihedralled tailplane only, without a fin. It is more usual to use a fin, however, for reasons of directional stability ;

FIG. 35.

CORRECTING EFFECT OF SIDE AREA PLACED ABOVE
THE CENTRE OF GRAVITY AND LATERAL AREA.

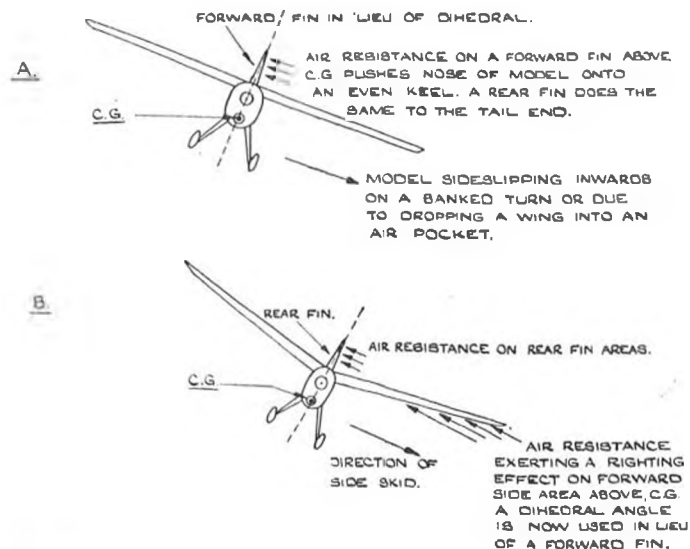
NOTE-

IT IS POSSIBLE TO USE A DIHEDRALLED TAIL PLANE IN LIEU OF A FIN, OR A DIHEDRALLED TAIL PLANE IN COMBINATION WITH A SMALLER FIN. A NUMBER OF FULL SIZED MACHINES USE THIS LATTER METHOD.

sometimes a combination of fin and tail dihedral is given. A fuller explanation is given later.

Now comes the important point. We must take care to balance the side area shown forward by the dihedral angle and the fuselage area above the C.G., with the fin and fuselage area at the rear. *Many models are unstable laterally and spin because the designer does not grasp the above fact.*

If the rear fin is too large, then the rear of the model will be pushed back more rapidly than the nose, and the

FIG. 36.

BALANCING THE SIDE AREAS FORE AND AFT
ABOVE THE CENTRE OF GRAVITY (C.G.) IN ORDER
TO OBTAIN LATERAL STABILITY.
SEE FIG. . . FOR REASONS.

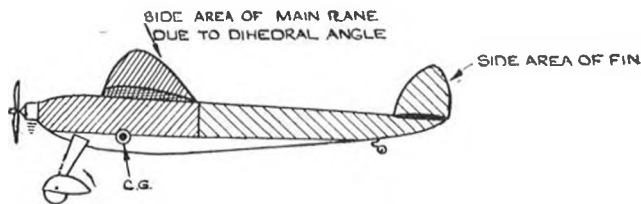

result will be that the nose will continue to slide inwards and drop ; thus the model will get into a very steep nose-down spiral or a spin. If, on the other hand, the forward dihedral is too great, the nose will be held up and the tail will drop sideways, with the result that the model stalls into a spin. It must be decided how much dihedral is required to right a slide-slip or air disturbance, and then the dihedral must be balanced by the fin at the rear. If the reader studies Fig. 36, he will not forget to include the fuselage area above the C.G. and the centre of lateral area. *This is very important !*

From the practical angle, Fig. 37 will perhaps drive the point home more than a sketch, for the photograph

shown is of my old "Blue Dragon" record holder taking off from the ground in the 1934 Sir John Shelley Power Cup competition. The model won the cup and set up a record that remained unbeaten for a number of years. It will be noticed that the fin is very large. This had to be done in order to balance the very large dihedral angle of the mainplane, as I decided that in all probability the weather would be bad, and I had determined to win the cup if possible. I knew that a very large dihedral angle



Fig. 37. The author's 8-ft. span "Blue Dragon" taking off to win the Sir John Shelley Cup, 1934, and set up a new record. Notice the exceptionally large fin. The reason for this is explained in the accompanying chapter. The well-known personalities, Mr. Rippon (Rip) and Mr. B. K. Johnson, are seen taking photographs.

would quickly right the model in gusty weather. As had been expected, the day turned out to be bad, and this pessimistic outlook was therefore justified. It is worth mentioning that, if the fuselage had been a long one, I could have fitted a smaller fin, because the extra length of fuselage would have given the fin a greater leverage.

The model was 8 ft. span with split wings. I had to keep the fuselage reasonably short in order to make it

easy to carry in the rather small back seat of a sports Aston Martin car that I had in those days. This meant a very large tail and fin.

With modern knowledge I might have used a smaller fin if I had used a dihedralled tailplane (see remarks *re* dihedralled tailplane later in this chapter). I should also have used a deeper fuselage forward, because there must be sufficient area below the C.G. to prevent swinging outwards on a turn, due to centrifugal force.

Design must be a compromise and a matter of reasoning out a given set of requirements to fit the situation.

If the designer desires to make a model fly straight, he should have plenty of area low down in the fuselage up forward—wheel spats help this. If a model is desired to circle freely in the air, there can be less area below the C.G. Very few people seem to understand this fact. It is a particularly useful piece of knowledge when designing a sailplane to soar directly into wind!

Directional Stability

Directional stability is obtained by a greater ratio of side area to the rear of the model's vertical turning axis, which runs through the centre of gravity. This area keeps the model on its course. The fin must not, however, be too large or the balancing of side areas, as described, will be out of proportion and so upset lateral stability. If a model rocks from side to side on its dihedral, and the tail also wags in indeterminate fashion, then the fin area should be increased.

The Biplane Set-up

I have found that the most stable set-up for a model biplane is to fly the top plane at a slightly greater angle of incidence than the bottom plane, and also to give the planes considerable positive stagger.

The leading edge of the top plane is located well in

advance of the leading edge of the bottom plane. In this method, the bottom plane becomes a very large tailplane flying at a smaller angle than the top plane, and so ensuring the necessary longitudinal V for stability, which I have already discussed. We add a tailplane for appearance and because it also helps the bottom plane, which has such a short moment-arm. It is quite possible to obtain flights from a model biplane constructed on these lines and without a tailplane, provided the positive stagger is considerable.

Further Points of Design

A question which faces the designer when he is laying out his "pipe dream" is "How long should the fuselage be?"

As a rough guide, a normal parallel chord wing should have approximately $1\frac{1}{2}$ to 2 chord lengths between the trailing edge of the mainplane and the leading edge of the tailplane. A tapered wing or an elliptical wing with a large root chord can suffice with $1\frac{1}{2}$ -chord lengths, otherwise the fuselage becomes too long for portability. A large tailplane is necessary in the latter case. *It is as well to remember that the main weights should be concentrated well forward and all near one point—the C.G.—the tailplane then has an easier job and can do it more quickly.*

The majority of aero-modellers design their fuselages too short because they copy full-sized aircraft, which fly at a greater speed and therefore require a shorter moment-arm. It is also sometimes thought that the longer a fuselage is, the better the results will be. This is not so. Too long a moment-arm makes the tail too sensitive, which in turn accentuates any maladjustment of the model. A suitable compromise must therefore be made.

One is often asked how to predict where the wing will be situated when building a new model. When a few models have been built, it becomes very easy from

experience to say within very small limits where the wing will come. It is best, therefore, on one's first model to design the wing so that it can slide along the fuselage for adjustment.

The reader is reminded that the centre of gravity (C.G.) should be about one-third back from the leading edge of the mainplane if a non-lifting tailplane is fitted, or from two-thirds to three-quarters in the case of a "lifting" tailplane.

Tailplanes

Tailplanes should be large in span and chord. It is useless to expect super stability by fitting a "scale" type tailplane.

I myself favour a slightly cambered type on the top surface. See my remarks on "lifting" and "non-lifting" tails earlier in this chapter. The tailplane should be built as lightly as possible without danger of warping. (See method of building in Chapter VII on construction.) Tailplanes for petrol models should never be less than 33 per cent. of the mainplane area. Large tailplanes are an advantage.

The Dihedralled Tailplane

Many readers will have noticed the modern tendency to use sharply-dihedralled tailplanes on twin-engined fighter bombers and flying boats of this war. The "Beaufighter" was one of the first aircraft to blossom out with a changed tailplane of this nature. As is well known, this was done to counteract swing during the take-off when two outboard engines are fitted. It is not always realised, however, why the dihedralled tailplane does prevent swing.

For structural reasons and reasons of weight and convenience, fuselages are often rather short and fins not very large on this type of aircraft. At flying speeds (fast

flight) the fin, with its comparatively short moment-arm, is perfectly effective, due to the high speed of the air reacting upon it, but at the initial low speed of the take-off the slower speed of the air on the small fin at the end of its short fuselage is not very effective. The aircraft is then prone to swing about. This is also true on some aircraft during flight when flaps are lowered and the speed is vastly reduced.

The answer, of course, is to build a longer fuselage and thereby give the fin a more powerful moment-arm at low speeds, or alternatively build a larger fin. In practice, neither of these expedients may be suitable, partly because it would completely alter production of an existing machine and partly because it would alter the C.G. position and introduce many other changes.

Another practical answer is very simply arrived at by giving the tailplane a sharp dihedral angle. Weights and dimensions of fin and tail and also fuselage are all the same *and yet we add to the side area shown aft*. This added side area keeps the machine steady directionally during the slow speed part of the take-off or during the very slow "flapped" flight.

The question arises, "Is the dihedralled tailplane of any real value on the model?" The answer is "Yes" in certain circumstances, but these circumstances are rather different from those of a full-sized aircraft.

Our general purpose model does not have a great variation in speed. It takes off, and also flies, slowly, we hope! We also keep our fuselage long, if we are wise, to give us a good moment-arm, as we are not hampered with considerations of design other than reliable, stable, and *slow* flight.

On a rubber duration model, unless we use a weight in the nose, we may sometimes find the mainplane set rather far back on certain designs, which may give us a small moment-arm.

Here we can *keep a small, light fin* by adding dihedral to our tailplane, to add to the side area aft.

That is one way of using a dihedralled tailplane. The second is on a low-wing plane. Even when the tail is set high on a low wing, it often operates in disturbed air, and in certain attitudes of climb is somewhat blanketed. I have therefore always advocated a longer fuselage for a low-wing model and have found this to be one of the important factors in low-wing model design. Incidentally, that is why careful filleting or streamlining of the low wing into the fuselage is carried out in full-sized machines to reduce this disturbance as much as possible.

Now a model low wing usually has a fairly large dihedral angle on the mainplane. In other words, the mainplane rises fairly sharply from the root. As a result, it will be realised that the airflow disturbance of the mainplane also rises at a fairly large angle. It is therefore obvious, if we have a short fuselage on a model low-wing, the tailplane tips will be in more disturbed air than the root of the tailplane, which is fairly free due to its being set high. We can thus either increase the length of the fuselage to get the tail as far away from the mainplane disturbance as possible, or we can dihedral the tailplane to keep the tips as free from disturbed air as the roots. Perhaps a combination of both is the best answer.

Finally, if one uses twin fins on a petrol model flying boat, as I often now do, with the fins set looking slightly outwards in order to get a slight *drogue* effect to keep the boat's nose into wind during the vital take-off the water, a dihedralled tailplane will permit the twin fins to be quite small and very light, as quite a considerable amount of side area aft is shown by the dihedralled tailplane.

Thus we may summarise by saying that the dihedralled tailplane can give us a percentage of our side area aft without adding any extra weight due to a larger fin. Perhaps I should add that the tailplane itself must not

be too small, for dihedraling it will rob it of its lifting virtue if it is of the lifting type. One should never fit a small tailplane on a model anyway! As a matter of interest, it is, of course, quite possible to fly a model with a *large sharply-dihedralled tailplane* by itself and without any other fin.

Aspect Ratio

Aspect ratio is a highly discussed matter amongst aero-modellists. A high aspect ratio, i.e. a large span and narrow chord, will give rapid lift and good climb, but a lower aspect ratio will help both longitudinal and lateral stability. In rough weather a short span wing rights itself more rapidly. That curious thing called "scale effect" also comes into the picture, and, broadly speaking, without going into a long technical explanation, in model wings a large chord is more efficient than a small chord, provided that wing-tip losses are not excessive. Some surprising results have been obtained recently with low aspect ratio gliders, where tapered or elliptical tips are used to save tip losses.

Apart from the findings of fellow-experimenters, I have made exhaustive tests myself and can vouch for these facts. Of course, the aspect ratio must not be too low. If parallel chord wings are used, then the aspect ratio must remain reasonably high in order to save tip losses.

To summarise—

The aero-modellist will do well if he is a novice to start off with a parallel chord wing, because it is easy to draw in and to construct. This wing must have a reasonably high aspect ratio. As the novice progresses, he should attempt tapered wings and elliptical wings, and when he has learnt to construct them, he will obtain the stability and advantages which they afford. Tapered and elliptical wings can have a really hefty central chord and quite

FIG 38
WING SECTIONS FOR PETROL MODELS

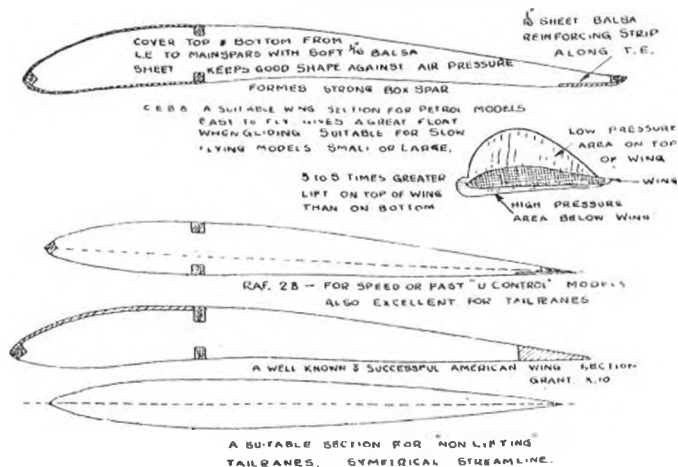

a shortish span. The elliptical wing is the answer to the petrol model enthusiast's prayer! If a tapered wing is used, it is most important to taper it in the correct way to obtain stability. See Fig. 39.

Wing Sections

A very thick wing section gives slow flying, but causes considerable drag, which in turn requires power to fly it. The centre of pressure moves back a considerable distance on a very thick wing, as the model climbs at increasing angles. For these reasons, it is usually better to obtain slow flying with a minimum of engine power, by a medium thick wing and plenty of surface and a slight under camber. A reasonably sharp entry and a slightly reflex trailing edge helps to keep the centre of pressure as constant as possible.

If the centre of pressure moves considerably at varying

angles of attack, it will obviously upset longitudinal stability. See Fig. 38.

Highly-tapered Wings

It has been proved that highly-tapered wings stall first at the tips and last at the root, or centre chord, except in cases where the leading edge is kept straight and the trailing edge swept forward. The most vicious tip stallers are those wings with trailing edge straight and leading edge swept back. The parallel chord wing stalls at the centre first and the tips last.

For model work, we obviously require a wing that stalls at the centre first and the tips last, in order to prevent the model from dropping a wing at high angles of climb. Therefore the petrol model designer does best when he uses either a parallel chord wing or a tapered wing with straight leading edge and swept forward trailing edge. See Fig. 39.

The elliptical wing like the "Spitfire" wing has the stability features of the tapered wing with leading edge kept straight and trailing edge swept forward. With all its other attributes, I therefore repeat that the elliptical

FIG 39

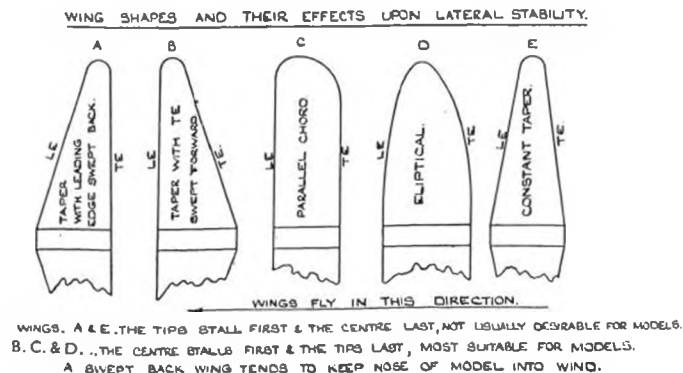

wing is the answer to the aero-modellist's prayer in many ways.

Slots

As far as I know, I was the first individual to produce a petrol model with successful wing-tip slots. These were of the built-in letter-box type and have a quite outstanding effect. The model can be climbed at what appears to be an impossible angle without stalling. It will level off as its engine cuts out, and the model, if adjusted nose light, will glide with its nose right up, sinking rapidly on an even keel to make a real three-point landing. I have tried this out on a small over-powered model and also on a petrol model flying boat. A design is given in a later chapter for a slotted model.

The principle is quite simple. By fitting slots along the leading edge of the wing tips, we keep the air flowing smoothly over the tips when the centre of the wing has stalled, due to flying at too great an angle of incidence. The wing tips therefore do not stall and do not drop a wing, causing a spiral dive. Instead, the whole model sinks on an even keel when the centre of the wing stalls until sufficient flying speed is regained. Construction of these slots is described in Chapter VII. The principle is shown in Fig. 40.

A slightly smaller angle of incidence should be given (termed washout) to all model wing tips, even when wing-tip slots are fitted. Alternatively, a different type of thicker section can be introduced towards the wing tips with a reflex trailing edge and no under camber. These devices are meant to delay the stall at the wing tips. When I do not fit wing-tip slots, I use either of these methods. As stability is the reason for fitting slots on a model, it is a mistake to fit slots along the whole length of the wing. This defeats the purpose of making the tips stall last.

A few individuals maintain that these wing-tip slots have no effect. The reason for this is that they have not been properly fitted. Professor Prandtl discovered that the L.E. of a slot for maximum effect should be situated in line with the L.E. of the wing. The opening should, of course, be greater at the front than at the rear.

Dr. Forster and I were recently gliding his flying boat and we were puzzled as to why one wing lifted more than the other, until we noticed that the top covering of the slot on the wing with more lift was raised considerably, due to a warp of his sheet covering. We corrected this warp, and both wings then remained on an even keel when gliding—on a slow-speed wing a "disruptor" will increase lift, and this raised slot top was acting as a disruptor. That is why I make my slots by *carving from solid balsa*. They do not warp, especially if supported in the centre by a small distance piece.

FIG 40
HOW A WING TIP SLOT FUNCTIONS

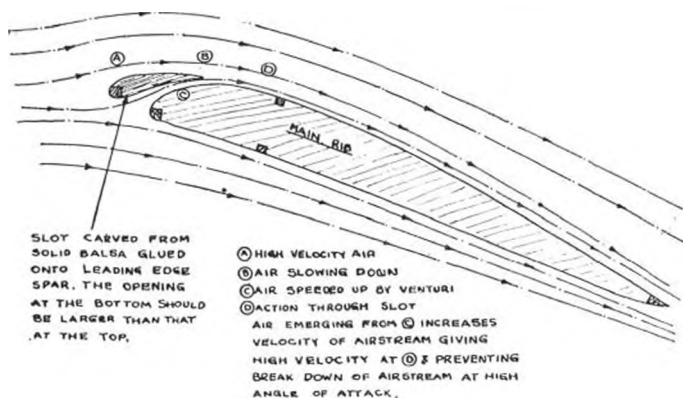

A Model for Maximum Stability

As a final summary: if it is desired to build a model with maximum all-round stability, both on the glide and

under power, it is best to make a compromise and situate the wing just above the thrust line, but not *far* above it. The span should be moderate with a fairly wide chord. An elliptical wing is the best to attain these features. Place the tailplane approximately $1\frac{1}{2}$ to 2 chord lengths behind the mainplane and keep the tailplane large. In a low-wing design always keep at least two chords lengths. Elliptical wings can have a little less. Keep the main weights concentrated around one point, well forward and fairly low down, and keep the wing loading down to about 8 ozs. to 14 ozs. per square foot.

Use a suitable wing section as described and have plenty of dihedral angle. *Be sure to balance this dihedral angle with the correct area at the rear, i.e. fuselage and fin.* Give sufficient "offset" of the engine to counteract torque, set the fin *straight*, and give sufficient down thrust according to power output to prevent undue climbing, and you should have a stable model. If you wish your model to turn, then turn on torque and not on fin. See Chapter VIII on flying a petrol model for the reason for this.

CHAPTER VI

GENERAL DESIGN FEATURES TO ENSURE RELIABILITY AND PREVENT DAMAGE

RELIABILITY and the prevention of damage are the two features which help to make the petrol model aeroplane enjoyable, and therefore popular. It is well worth while, when considering the design of a model, to include features that will give every possible help towards these two important requirements.

Too many people are content to obtain good looks, and are satisfied if their model will *just* fly. They forget that good looks sometimes conflict with reliability and freedom from risk of damage. A model that will only fly a few times before extensive repairs are required—or a model that requires constant repairs—is to the average individual a source of irritation as well as involving wasted constructional effort and unnecessary expense.

It must be obvious that the first and foremost aim is to produce a really stable model. This in itself will help in avoiding damage and in promoting reliability, but even this is not the whole answer.

I have discussed the practical angle of stability at some length in the preceding chapter and need not remark further upon this side of the problem. The correct method of testing and flying the model is obviously vital, and I have devoted a chapter to the subject at the end of this book. It is also vitally important to have a reliable engine that will not cut out shortly after taking off, a point which is thoroughly discussed elsewhere in this book. Apart from these considerations, how can we, in

the design of our model, ensure that it is reliable and not easily damaged?

Firstly, any form of rigid fixing of wings, tail or fin is bound to cause damage if the model should crash or fly into any object. Strut and wire bracing also lends itself to damage, and after a heavy landing often becomes strained, thus altering the settings for the next flight. Therefore let us :—

(a) Attach our engine, wings, tail and fin by flexible attachments, such as rubber bands or springs, so that they are sufficiently firmly held to withstand the loads of thrust and air resistance, but will knock off in the event of a sudden severe blow.

(b) Eliminate any form of strut or wire bracing.

All component parts in this book comply with (a) above and strut and wire bracing is not even considered. I abandoned these in my very early days. No really up-to-date full-sized design now uses strut or wire bracing because of the unnecessary drag.

(c) See that engines are mounted on detachable mountings.

(d) Wings, tail and fin are all detachable and held in position by rubber bands which can be strengthened to the right tension. These components should be mounted on sufficiently wide and firm platforms to prevent moving due to vibration. It is a good plan to cover wing and tail mounting platforms with glass paper or emery cloth to prevent slipping. I have often used coil springs to retain component parts, such as engine mounts and wings, but have not found them as satisfactory, generally speaking, as rubber bands. There is considerable scope for ingenuity in hiding rubber band fixings, but it is also important not to make these fixings inaccessible if ease of operation and flyability is to be obtained.

(e) Fuselages are far stronger if covered with light-weight $\frac{1}{16}$ -in. balsa sheet or planks and then silk covered

and doped. The extra weight is not great, but it is well worth while in this treacherous climate of ours, where we seldom fly in really calm weather. It will make the model much less prone to damage both when handling during launching and also if it should fly into a tree or similar object. It is a protection also when the model is being transported to and from the flying field.

Wings and tailplanes having a $\frac{1}{16}$ -in. light balsa sheet covering from leading edge to mainspars are far less liable to damage than those without. The wing section is maintained better where the air pressure is greatest and the resulting airflow is therefore superior. Fins made on the principle described in the chapter on construction also suffer very little damage. The method that I mention in connection with the construction of trailing edges of wings will prevent distortion and warping, which so often causes bad flying, and even a crash.

My experience has been that it is not worth while covering a petrol model with paper, except in the case of very small models where cheapness is required. Silk makes a far more reliable job and the dope should invariably be full strength (full-sized) glider dope. A number of coats of thin model dope tend to slack off too easily when there is damp in the air or water is picked up from wet grass. Very thin cotton material can be used instead of silk, but this is heavier, i.e. fine tarantulle or nainsook. There is a new and very tough material of a paper background recently discovered that is worth using when silk is unobtainable. I believe it has a cellulose basis. Nylon may also be used, but has a slightly different technique for covering.

(f) The undercarriage position and its action is of the greatest importance. Firstly, the undercarriage *must be well forward of the C.G.* if the model is to get away with landings without turning over on to its nose. Secondly, the undercarriage must have an initial movement back-

FIG. 41.

UNDERCARRIAGE ACTION OF A PETROL MODEL AEROPANE

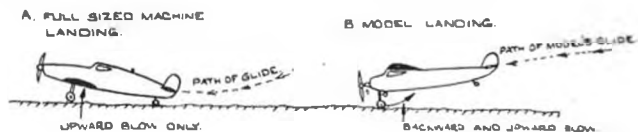

wards and then upwards—and not merely upwards (as in the case of a full-sized machine)—because a model glides *into* the ground and does not have a pilot to pull up the nose and stall the machine *on to* the ground in a three-point landing, as is the case in full-sized aircraft. Fig. 41 will make this very important point clear. A spreading movement of the legs is also very helpful.

(g) Finally, the fitting of wing-tip slots, as described elsewhere, is a great help. If wing-tip slots are not fitted, then the wing tips should have a slight “washout,” i.e. a slightly lesser angle of incidence. The plan shape of the wing must be correct or the model will be laterally unstable. See previous chapter.

CHAPTER VII

METHODS OF CONSTRUCTION. INCLUDES MAKING THE DRAWING; BEGINNING CONSTRUCTION; THE FUSELAGE; UNDERCARRIAGE; WHEELS, WINGS AND TAIL UNITS; WITH NOTES ON MATERIALS AND TOOLS

Constructional Methods

MANY variations of construction have been evolved for petrol models. I have naturally tried, over the years, most of the worth-while methods. If the reader becomes bitten with the germ of petrol model building, he will also try out many methods, for that is part of the fun of the game. It is not possible, for reasons of space, to discuss all these methods in this book, but I propose to group certain methods that I have evolved myself or have used and found from experience are sound and produce satisfactory flying models. The newcomer to the hobby will then have something from which he can start off, whether it be a simple general-purpose model, a streamline monocoque model, a seaplane or a flying boat.

General

Many aero-modellers will wish to construct their first petrol model from a kit of parts that can be purchased complete with everything required for building the model. It is as well for the beginner to buy his first kit of a well-known design that has proved itself as a good flying model and one that has a *full-sized drawing* of the model from which to build. Full-sized drawings of well-known models can also be bought, in which case the constructor buys his own materials separately. Alternatively, he may

decide that he wishes to design his own machine. He must then make his own full-sized drawing from which to work, and if he is a novice he should study the preceding chapters before designing his model and making the drawing. In each of the above cases, once the drawing is available, the next step is to cut out formers, ribs, etc., by tracing these on to the specified wood, using sheets of carbon paper between the drawing and the wood. A single-edged safety-razor blade is the best cutting tool for balsa sheet and strip.

When the bits and pieces have been made, the drawing must be placed on a flat table, or board, and covered with greaseproof paper to prevent glue sticking to the drawing. Building may now begin on the drawing, which will show up through the transparent greaseproof paper.

Making the Drawing

When designing one's own model, it is as well first to make a small arrangement sketch of the model that is proposed, with approximate dimensions. The full-sized drawing can then be begun from the small sketch. The next stage is to procure some large sheets of paper; cheap white kitchen paper will do, and this can be bought in rolls, together with sheets of transparent greaseproof paper from Woolworth's or from a stationer. I make my own working drawings on this paper, build my model from it and, after having made any modifications that may be found necessary during flying trials, I then produce final drawings on good paper if I wish to have a print made or to keep the design as a record.

In order to show the complete novice a simple method of making his drawing, I have included Fig. 42, which illustrates the elementary principles of layout of a model.

The "side elevation" should be started on first, followed by the "plan" or top view. A rectangular fuselage is shown, but, as the reader progresses with this

book, it will be evident to him that a similar method can be used in laying out a circular or oval monocoque fuselage, and that only slight modifications will be necessary.

Begin by drawing a central line lengthways and call it

FIG. 42.

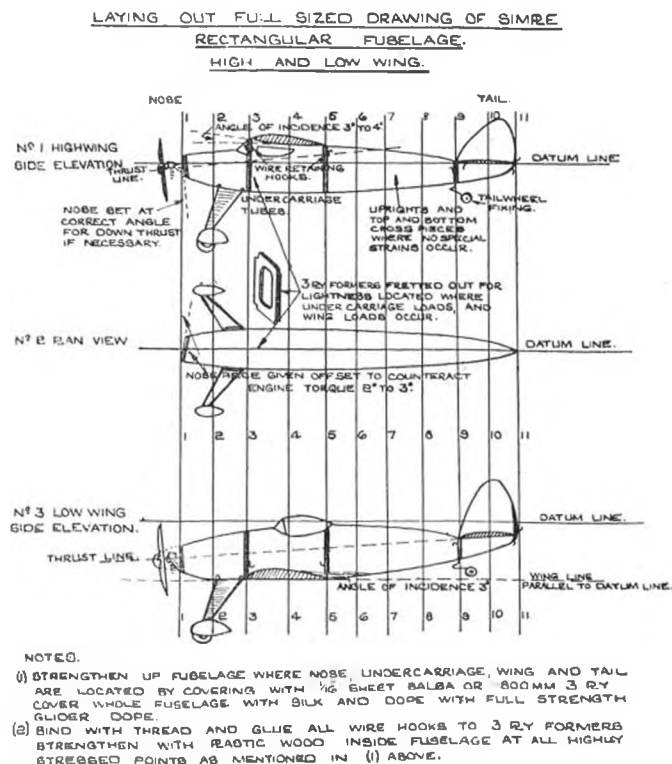

the *Datum Line*. Mark off the length of the fuselage on this line. The wing and tail positions and other details to comply with the requirements of stability given in the chapter on this subject can then be arranged. Angles of incidence of mainplane and tail can be measured from

the datum line. These matters are then not left to chance, and each must be considered in relation to the other. The thrust line can be put in and down thrust, if necessary, be added. Offset of thrust line to allow for engine torque can be shown on the "plan" view. (See chapter on stability.)

The desired outline shape of the fuselage can now be drawn in, so that the centre of pressure of the wing will come in the correct position in relation to the thrust line. (Again see chapter on stability.) *The undercarriage* should be located *as far forward as possible* to prevent the model from nosing over on landing. Never position the undercarriage just about the C.G. position as in full-sized practice. *It can scarcely be too far forward* except on an R.O.G. competition model, when the importance of good, unassisted take-off may cause a slight compromise to be necessary.

Now draw in the uprights and the position of specially strong formers where you visualise that strains of undercarriage loads and wing fixings will occur. Number these formers and uprights from front to rear. (Refer back to Fig. 42.)

Next draw another *Datum Line* some 12 in. or so below the completed side elevation of the fuselage and parallel with the first datum line. Now extend the upright lines so that they cut the lower datum line and continue for 6 to 9 in. The top or plan view can now be drawn in to suitable widths to accommodate the wing and tailplane platforms. The platforms should be reasonably wide to make firm bases for these components.

You now have the correct height and widths of all formers, uprights and crosspieces. Any three-ply formers can therefore be drawn in on a separate sheet of paper. Uprights and crosspieces can be cut and marked.

Decide the location of the battery, coil, etc., and draw in all fittings that you consider necessary, including hooks

for engine, wing and tail retention and undercarriage fixings. You are now ready to start construction of your fuselage.

If you decide to build any of the models given at the end of this book, you should draw in the all-important *Datum Line*, then measure off components from this line, taking the measurements given on the small plan. If you are a complete novice, you will find it an absorbing pastime. On each plan I have given the largest and the smallest rib, full size, so that the reader can draw in his wing sections as shown in Fig. 65, "How to Draw a Wing," shown later in this chapter.

Construction of the Fuselage

Broadly speaking, a fuselage may be constructed by one of four main methods.

No. 1 Method: The Simple Rectangular Longeron Fuselage. Pin the full-sized side-elevation drawing of the fuselage, covered with greaseproof paper, to a suitable building board. Having soaked longeron wood lengths in hot water for about half an hour to make them pliable, place your top longerons one above the other on the drawing, with pins on either side to keep them in position above the outline drawing. Longerons can be either of spruce or birch, or of balsa wood if the model is small or covered with $\frac{1}{8}$ -in. balsa sheet. Now allow 24 hours for the longerons to dry out and to set hard. They will then keep their shape. See Fig. 43.

Place little pieces of greaseproof paper between the two top and two lower longerons where the uprights will come, so that the sides will not stick together. Now glue in uprights. If hardwood is used, a casein glue is best; if balsa, a cellulose glue should be used, usually known as balsa cement. When the glue has set, the pins can be removed, and the two sides of the fuselage separated.

The three-ply formers, where decided upon, can now be inserted, bound at the corners and glued into position. The nose and tail formers are then inserted. Finish by

FIG 43

A SIMPLE LONGERON FUSELAGE ON ITS BUILDING BOARD

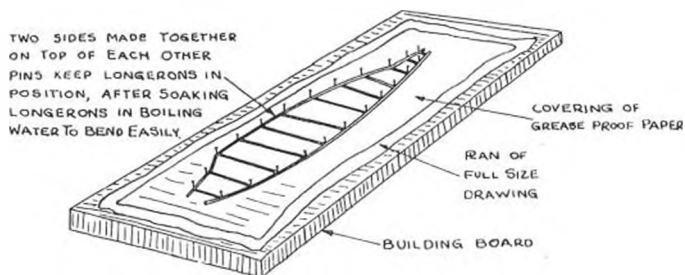

gluing in the top and bottom crosspieces. Wire hooks and other fittings can now be added, bound with thread and glued into place. No cross bracing will be necessary if the fuselage is covered with silk and the correct strength dope is used. (For method of covering, see end of chapter.)

No. 2 Method: The Rectangular Fuselage covered with Balsa Sheet. In the early days of petrol model building I evolved a very simple and light, but immensely strong, method of quickly making a fuselage and, although I say it, I do not think this has since been bettered.

First draw the outline of the side elevation on to a sheet of $\frac{1}{16}$ -in. light-weight balsa. Having cut around the outline side elevation with a razor blade, lay the sheet on the building board. Now glue along the outside edges of the sheet, side longerons of $\frac{3}{16} \times \frac{3}{16}$ -in. balsa strip to $\frac{1}{4} \times \frac{1}{4}$ -in. strip, according to the size of the model. These longerons are well smeared with cement on the side next to the sheet and kept in position until the glue dries by ordinary pins. When dry, withdraw the pins.

Glue in the uprights in vital places where undercarriage

strains, etc., occur. Not as many uprights are required as in Method 1. Smear the sides of the uprights well with glue where they come against the sides of the sheet balsa. See Fig. 44. Weight the sides to the building board until dry to prevent distortion.

The two "sides" are now placed upright and cross-pieces are glued in. Next, fit the coil, ignition wiring, and wing retaining wire hooks, and undercarriage tubes. *Reinforce these well with plastic wood and glue.* Wire hooks to keep wings, tail, etc., in position with rubber bands should be made from fairly heavy spring steel wire of 16 to 14 s.w.g. Wooden dowelling protruding from a fuselage is also often used.

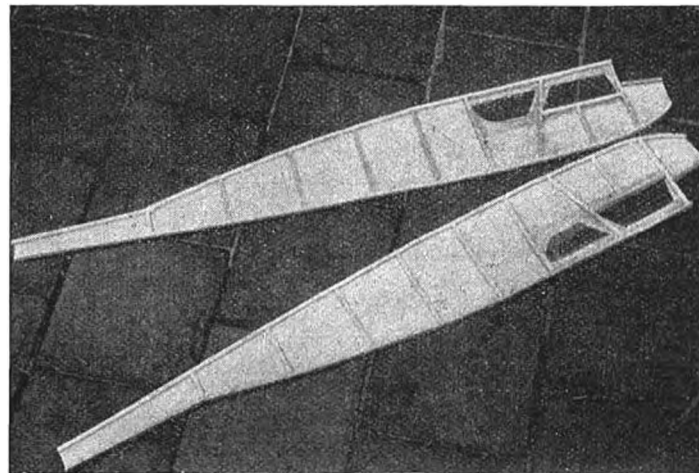

Fig. 44. A useful method of building two sides of a sheet balsa fuselage. The longerons and uprights are first glued on to the sheet balsa.

Now cover the bottom with $\frac{1}{16}$ -in. light-weight balsa sheet, using plenty of glue, and similarly cover the top with the same thickness sheet. Sandpaper the whole fuselage smooth and then cover with photopaste and silk.

Finally, dope with one coat of *full-strength* glider dope. Finish off with any coloured paint that is fancied or leave unpainted if the model is small and weight is of importance. This type of fuselage will stand a great deal of rough handling. Fig. 45 shows a simple jig that is quickly made, and helps in erecting this type of fuselage absolutely true.

Fig. 46 shows the two sides of the fuselage joined together by crosspieces and before the top and bottom sheet balsa is glued into position.

Fig. 47 shows the completed fuselage with detachable undercarriage and Bowden-type detachable engine mount.

The No. 3 Method : The Streamline Monocoque Fuselage.

FIG. 45.

A SIMPLE JIG TO ENSURE A TRUE FUSELAGE.

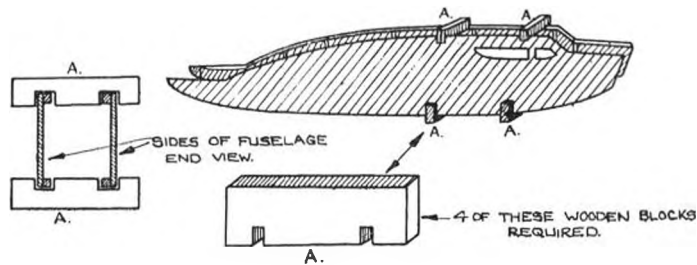

1. *The Hollowed-out Fuselage.* This type of fuselage can be produced by hollowing out two pieces of solid balsa. See Fig. 48, which is self-explanatory. All fittings require internal strengthening of plastic wood. In actual practice, I have found this method to be rather heavy, except in the case of speed models and U-control models, where it is satisfactory.

If the fuselage is well hollowed out for lightness, it is not usually as strong as the former and planking method described below, which has the advantage of cellulose glue strengthening between the planks.

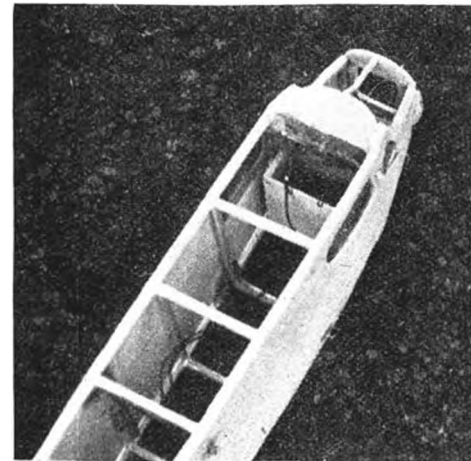
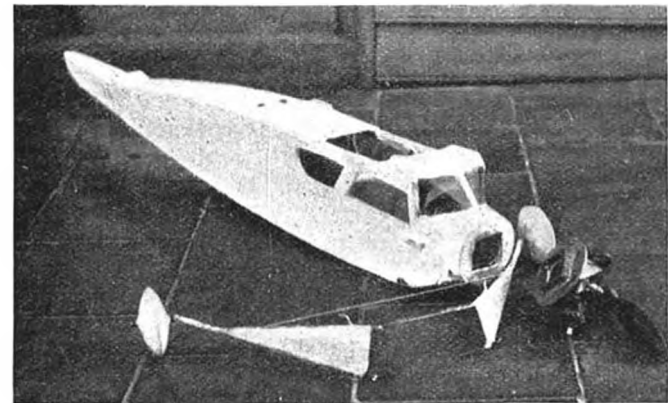

Fig. 46 The two sides are clearly seen connected by crosspieces of balsa.

No. 4 Method : The Planked Fuselage. Perhaps the strongest and yet the lightest monocoque fuselage is produced by planking over oval formers. The reason for this is that between each plank there is a layer of cellulose glue, which adds enormously to the toughness of the

Fig. 47. The author's completed fuselage, showing the No. 2 method, as described.



structure without greatly increasing the weight. This is the most popular method of constructing a monocoque fuselage.

Small planks can often be substituted by sheets of $\frac{1}{16}$ -in. balsa sheet several inches wide. A very light fuselage can be made in this way, but for the larger types of model the former method is best, and balsa planks $\frac{1}{16}$ -in. thick and either $\frac{1}{4}$ in. or $\frac{1}{2}$ in. in width are most

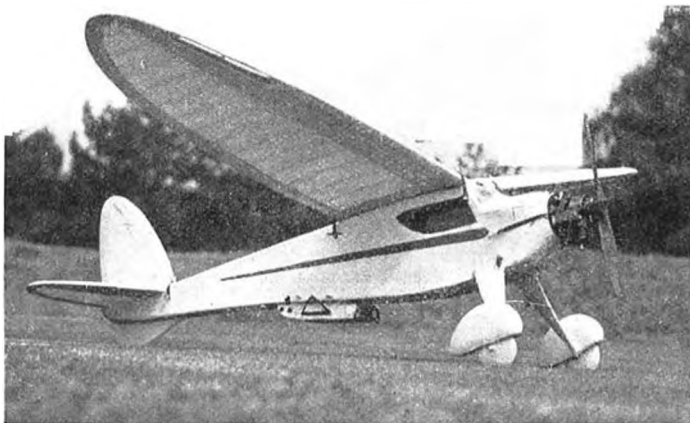

Fig. 47A. The "Bowden Contest," designed by the author, is on the market as a plan. The model was designed for ease of building by the novice and for competition work. The fuselage is built on the No. 2 method.

suitable. The $\frac{1}{4}$ -in. planks are, perhaps, easier to work with

If a very large 9-ft. to 15-ft. span model is being constructed, $\frac{1}{8}$ in. thick and $\frac{1}{2}$ in. wide planks may be used. The art of obtaining a nice smooth job with no sagging in outline is to space the balsa formers fairly closely. Very little extra weight is incurred if balsa formers are spaced every $2\frac{1}{2}$ in. rather than $3\frac{1}{2}$ in. In the future, moulded shells from plastic materials may become popular on commercial models.

FIG. 48.

MONOCOQUE MODEL CARVED FROM
TWO BLOCKS OF SOFT BALSAWOOD.

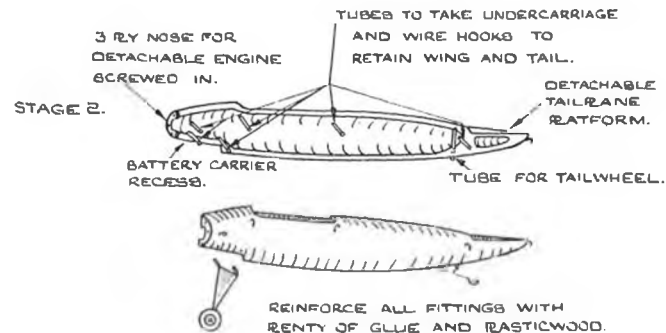
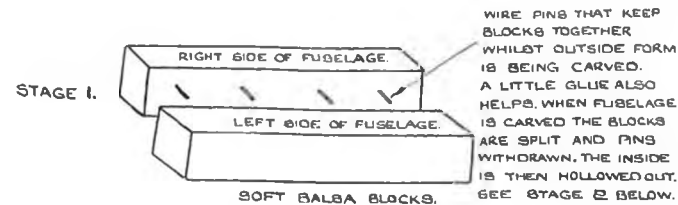

STAGE 3. COVER WITH SILK, USING PHOTO PASTE AS ADHESIVE. DOPE WITH FULL STRENGTH GLIDER DOPE (FULLSIZE) PAINT COLOUR OF CHOICE, OR POLISH WITH WAX POLISH

The first operation in producing a planked monocoque fuselage is to cut out a backbone of balsa sheet. The fuselage shell is then built up in two halves. Therefore cut out the balsa formers in half-rounds or half-ovals. One set of these half-ovals is glued on to the backbone, which is laid flat on the building board. See Fig. 49. Balsa planks are then glued over the half-formers and

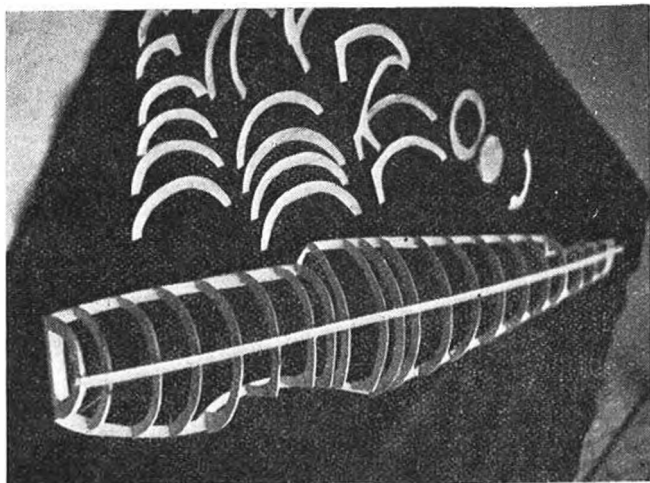
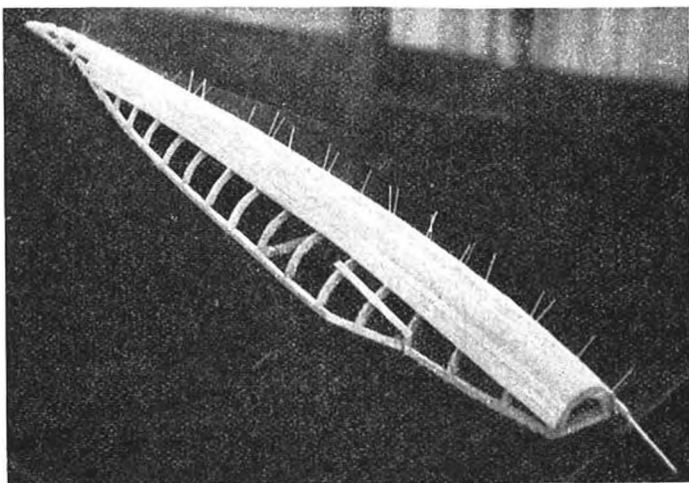

Fig. 49. The half-formers are glued on to the backbone.

Fig. 50. The balsa planks are now glued on to the half-formers. Note the temporary pins until the glue has set.



kept in position with pins until the glue is set. See Figs. 50 and 51.

A few planks are left out towards the top, so that fittings can be inserted into the fuselage later. The half-shell is now turned over and the other side half-formers are glued into position. When dry, begin planking the other side.

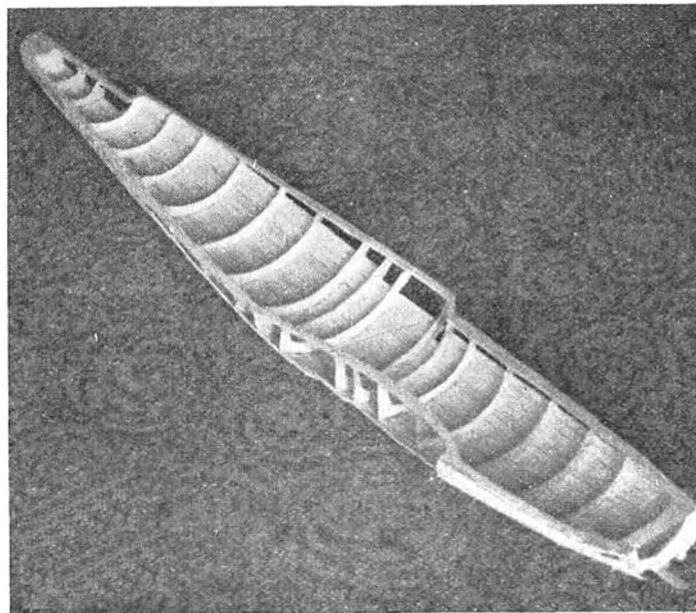

Fig. 51. The half-shell can now be seen ready for the next stage of completing the other side.

Be careful not to stint the cellulose glue. Planks should be *liberally* smeared between edges, as this glue makes the fuselage really strong. Planking is far easier than it sounds, and a very little practice soon makes perfect.

Now put in all fittings, wire hooks, dowels, coil and wiring and undercarriage tubes. Reinforce the balsa shell

inside *liberally* with glue and plastic balsa wood where these fittings come. This is the secret of a no damage and robust fuselage. Sandpaper carefully the whole fuselage until a really smooth outside surface is obtained. Now cover the whole fuselage with silk, using plenty of photopaste as an adhesive. Dope the covered fuselage with clear, full-sized glider (full-strength) dope. Later, paint the fuselage, if desired, a selected colour. The constructor then has a glossy, streamlined fuselage of great strength.

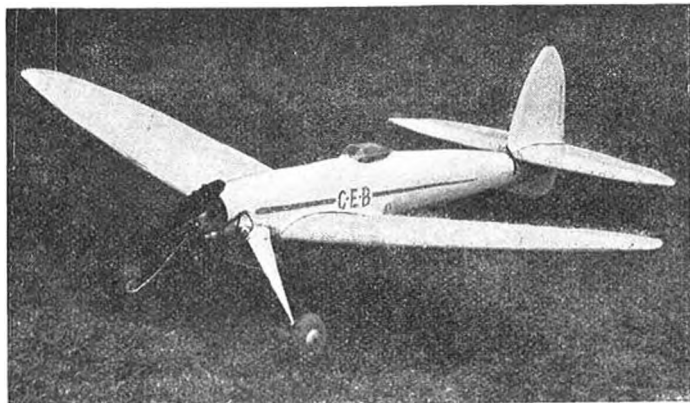

Fig. 51A. This small planked monocoque low-wing model, which has proved an excellent flying model, was made by the author on his No. 4 method.

Fig. 52 shows an oval fuselage built by the author for an 8-ft. span biplane. This model was not planked, but many birch stringers were attached, and the fuselage was then covered with silk. The method is often adopted, but is not nearly as satisfactory and strong as the planked fuselage of balsa wood. The latter is not much heavier. The slight extra weight does not matter on a large petrol model.

A more modern-shaped monocoque low-wing model that the author recently built can be seen in Chapter

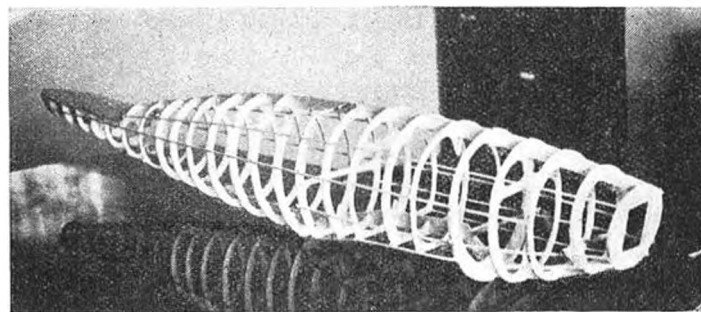

Fig. 52. The author's biplane fuselage half completed with stringers.

XII, which also describes how to build this model.

Fig. 54 gives details of another method of building a planked model. The undercarriage fitted is of the simple cantilever $\frac{1}{8}$ -in. diameter spring steel wire type, securely anchored in the fuselage. This type of undercarriage is suitable for light models and is much used in America.

Engine Cowling

There are several methods of cowling for the engine as suggested below. The main points to remember are : To ensure adequate cooling for the engine, accessibility of engine controls, quick removability for engine adjust-

Fig. 53. An early high-wing monocoque model built by the author.



ments, construction that will not easily suffer damage, and the cowling must not cause shorts from the sparking plug. As a result of attending to all these points, many people fly their models with no engine cowling. A good spinner and engine cowl undoubtedly reduce head resistance and, if carefully designed, are well worth while,

FIG. 54.

AN AMERICAN METHOD OF CONSTRUCTING
A RANKED FUSELAGE.

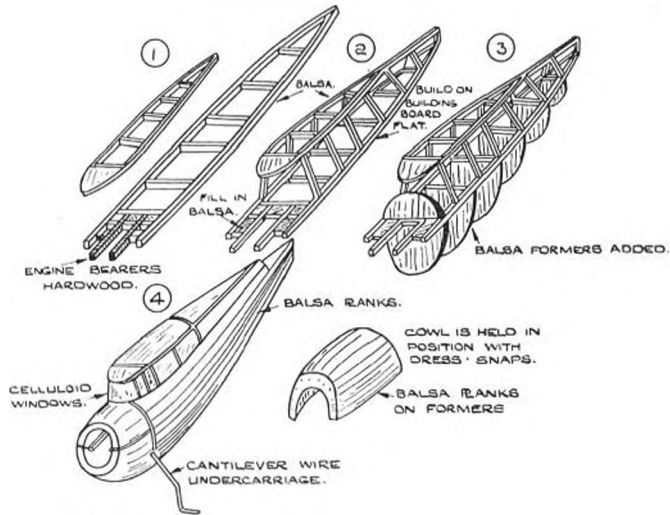

besides adding enormously to the appearance of the model.

(1) Cowls can be beaten up from thin aluminium sheet and then buffed up to a fine polish. I used to fit this type of cowl to my early models. See Fig. 55.

(2) Spun aluminium cowls of the large radial aero engine type look very effective. These may be bought in varying sizes and there are certain firms of sheet-metal workers who will spin cowls to the purchaser's special requirements for quite a small sum.

(3) Balsa cowls can be carved from solid block balsa and hollowed out, covered with silk inside and out to strengthen and then doped and painted. This type may be held in position to wooden bearers with press studs. Alternatively, the cowling can be built up on to formers by planking, as in the case of the monocoque fuselage construction already described. Balsa cowls are naturally not very strong and must be covered with silk, doped and painted, or the engine oil will ruin them. See Fig. 56.



Fig. 55. A beaten-aluminium engine cowling is here seen fitted to an early 9-ft. span model built by the author.

They are, however, popular because of their ease of construction.

(4) Cowls can be built up over a carved form from layers of paper and dope. These must be painted to give a suitable finish.

The Undercarriage

The correct action for a model aeroplane undercarriage is shown in Fig. 41 of Chapter VI. From this sketch, it

FIG 56

A METHOD OF CONSTRUCTING A BALSA ENGINE COWL

1. CUT THE 5 BALSA BLOCKS AS SHOWN, GLUE TOGETHER, FIT OVER THE ENGINE AND HOLLOW OUT WHERE NECESSARY.
2. CUT HOLES FOR CYLINDER COOLING EXHAUST PIPE AND NEEDLE VALVE CONTROL.
3. SANDPAPER TO STREAMLINE SHAPE.
4. APPEL TWO COATS OF WOODFILLER.
5. FOLLOW WITH SEVERAL COATS OF CEMENT OR DOPE AND PAINT.
6. ALTERNATIVELY COVER WITH SILK, DOPE & PAINT.

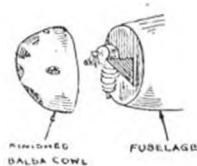
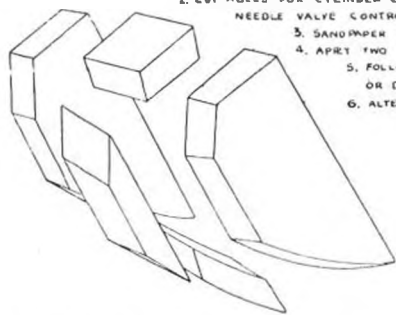

will be clear that the undercarriage, when taking up landing shocks must first have a backward movement, followed by an upward movement. This fact makes it difficult to design a really efficient model undercarriage that looks like the real thing. The full-sized undercarriage has an upward movement only, because the pilot is in the machine to pull up the nose at the last moment and semi-stall the machine on to the ground.

If we are to have successful petrol flights, we must have a strong undercarriage, as this component takes more knocks than any other part of the machine. It must also be well forward of the C.G. position. It is clear, then, that we shall have to compromise and be prepared to sacrifice something to look as if we are to have "no-trouble" landings. On my first petrol model in 1931 I fitted an elaborate affair of telescopic duralumin tubes and springs after the style of a full-sized machine. I had so much trouble that I quickly designed a more practicable type. As the aero-modellist progresses in his model making, he will no doubt design many different undercarriages, and perhaps evolve the ideal solution.

I propose to give a few examples of types that have

FIG. 57.

SOME SIMPLE TYPES OF UNDERCARRIAGES.

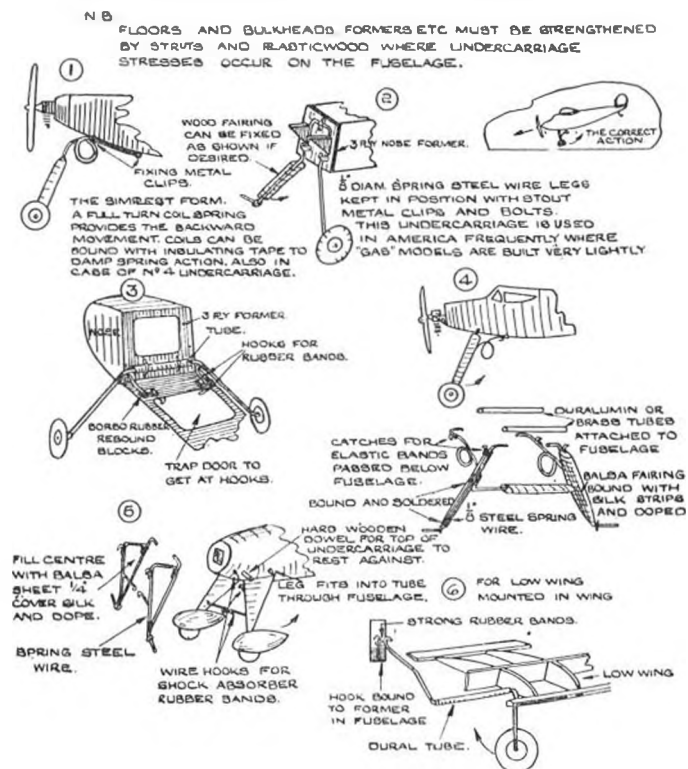

proved themselves satisfactory in practice. The reader will then be able to make a choice and have something from which to start off. Fig. 57 is a sketch showing several types, all of which comply with the backward and then upward requirement.

Most of these undercarriages can be seen fitted to models shown in photographs throughout the book.

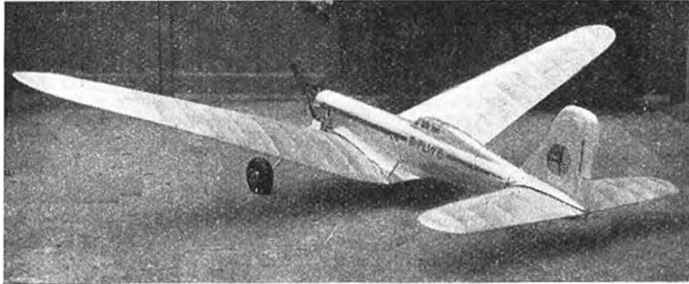
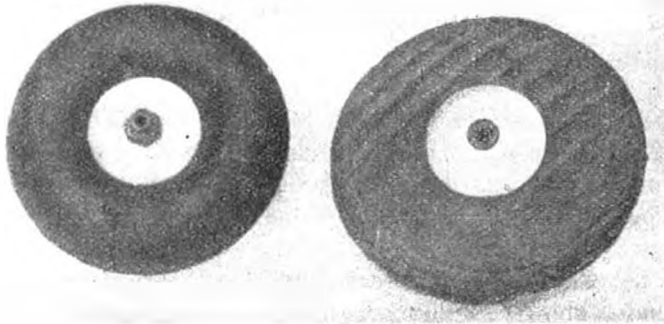

Fig. 58. A low-wing model fitted with M. & M. airwheels. Note the trimming tab fitted to the fin. The dihedral angle on this model was unnecessarily great, and was reduced later, with satisfactory results.

Wheels

Most aero-modellers will no doubt buy their wheels, and there are a number of types on the market suitable for petrol models. Some are of the very light type, like the M. & M. Airwheel (American). A special inflator is provided with this wheel, so that the owner can blow up the tyre by mouth. Fig. 58 is a photograph showing one of my medium-size low-wing models built a few years ago and fitted with this type of wheel.

Fig. 59. This photograph shows an air-wheel and a sponge-rubber tyred wheel. The latter is very light, and has a wooden hub. It is preferable to an air-wheel, which suffers from punctures and inflation troubles.



A number of airwheels are procurable which are rather heavier. They have wooden centres, with thick rubber tyres permanently inflated. When I built my "Record"

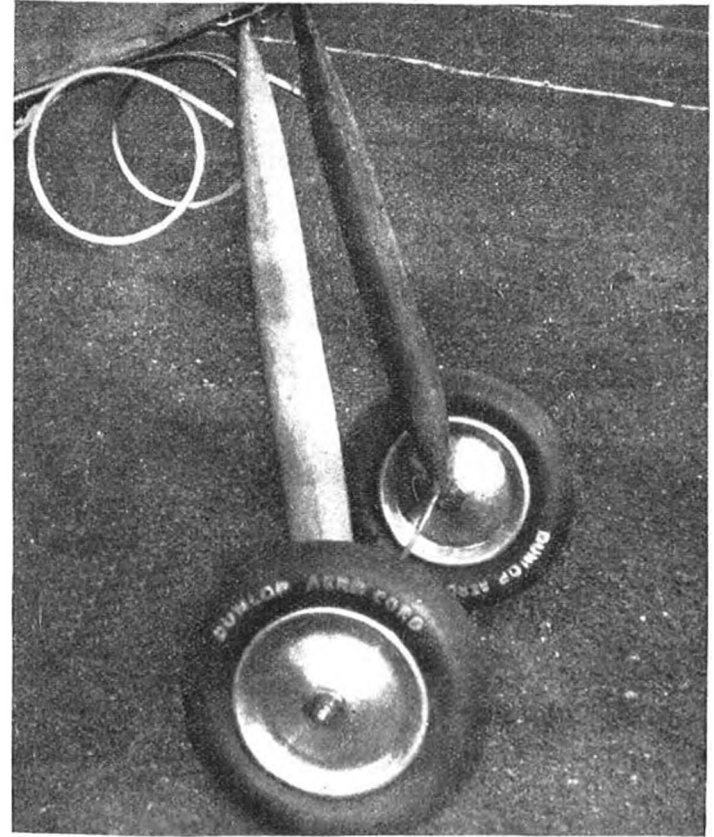
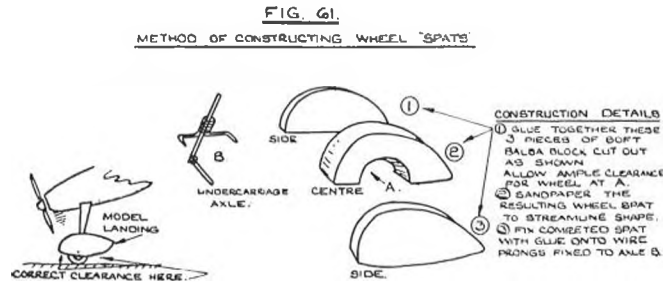

Fig. 60. Special wheels made for the author by the Dunlop Tyre Company.

machine "Kanga," after the 1914 war, I approached the Dunlop Tyre Co. to make me up some special wheels and tyres to my ideas. Fig. 60 shows these original wheels

built in 1931. They are still going strong to-day, and are the best thing I have discovered for large models. (Diameter of wheels $5\frac{1}{2}$ in.)

The tyre was constructed of flexible, but stiff, black rubber and had a flange on the inside—or hub side. This flange was nipped between two spun aluminium discs. Aluminium rivets passed through the two discs and the rubber flange in the centre, whilst a hollow axle bearing was mounted between the aluminium discs. On a cross-wind landing, with drift on, the tyre on a model tends to be wrenched off. This could not happen on



these wheels, because the tyre and its flange were firmly attached to the wheel.

For light models and competition models, a thin wooden wheel is excellent, because it is cheap to make and, owing to its thin rim, cuts through the long grass easily for the take-off. A big squashy rubber tyre offers a great deal of resistance for the take-off from grass. Naturally there is no shock-absorbing property in the wooden type of wheel, and the model must be either of light weight or with good shock-absorbing type undercarriage. I often used this type of wheel for competition work in the early days, even on models of up to 8-ft. span.

The wheel is very simple to make. Cut a three-ply disc and glue on to each side a thick disc of balsa sheet. Fit a brass axle tube and reinforce the centre with plastic wood and glue. Sandpaper the balsa sides to a streamline shape, cover the wheel with silk, dope it and paint to render waterproof. The appearance of the model can be improved by fitting what the Americans call "wheel

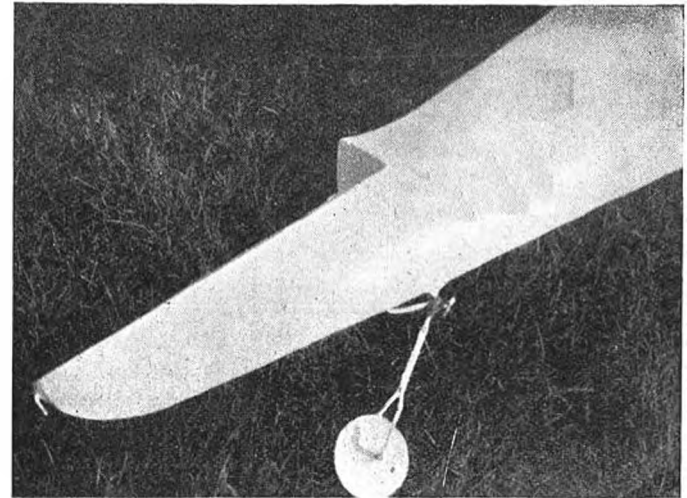

Fig. 62. A castoring tail wheel, as fitted to one of the author's models. A rubber band is attached from the tail wheel to a hook and forms a check on swinging. The wheel fitted is a simple wooden type.

pants." These can be easily and lightly made of balsa block. Fig. 61 should make this construction clear.

The Tail Wheel, or Skid

This component is rather more important than may at first be apparent. It must be anchored stoutly, because with the undercarriage fitted well forward of the C.G. the tail often comes down with considerable force in the

final phase of the model's touch down. A stout wire tail skid can be fitted made of really strong spring steel wire or, alternatively, a castoring tail wheel can be used, as designed by Dr. Forster. See Fig. 62.

A brass tube is fitted in the tail-wheel former of the fuselage, and must be well reinforced to withstand hard knocks. The tail-wheel mounting, or fork, is made from spring steel wire of stout gauge and shaped so that a rubber band can be passed around its forward bend to a wire hook, also stoutly fixed to the fuselage. For light models, a lower fin made of hollowed and laminated balsa sheet will suffice as a tail skid if reinforced at the bottom by a piece of wire to act as a skid.

Wings

There is a great deal of unnecessary weight and complication put into many model wings and also a great deal of nonsense written about them. The art of model wing construction is to make the design as simple as possible, strong, able to resist torsion and to keep a good airfoil shape under pressure of the air. Lightness with strength is required. Many people view a model wing's construction as something that should be copied from full size, but, like most model work, it should be a suitable compromise that will do the job in hand as efficiently as possible and be as trouble-free as possible.

Even when we do reduce all unnecessary work and construction down to bare essentials, there are a number of different ways of attaining the object. There is not space in this book to review all these methods, and I propose, therefore, to describe a method that I have found produces reliable flying results and the minimum of damage and repair work. The beginner will then have a jumping-off point.

In order to understand my remarks in connection with unnecessary constructional work which, incidentally, leads

to extra work when repairs become necessary, the reader should look at Figs. 63 and 64. In Fig. 63 it will be observed that there are a great number of cross-bracing birch strips. These are all unnecessary, as the fabric doped with the correct type of dope, namely full-strength (full-sized) clear glider dope, acts in lieu of cross bracing, provided a boxspar leading edge and a suitable trailing edge are used in any model wing up to 10-ft. span. In Fig. 63

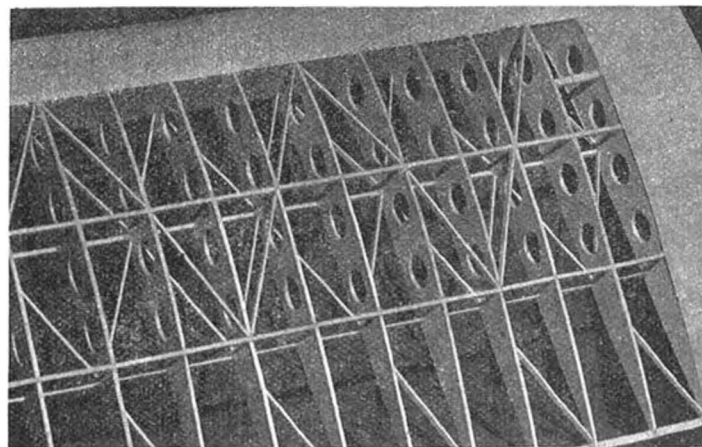

Fig. 63. Unnecessary complication of internal bracing is apparent in this wing. Also a weak and easily distorted trailing edge.

we see that the constructor has gone to all the trouble of putting in a multitude of internal struts, but leaves the vital trailing edge unsupported. As a result, distortion is likely to set in and one wing will have greater drag than the other.

In Fig. 64 we see a very nice-looking piece of work, but once again the vital trailing edge has been neglected and a great deal of complicated rib work put in which would be far more simple and lighter if cut from solid balsa sheet. Think of the repair work required on those intricate ribs.

I do not wish to discourage the reader who finds great delight in complicated workmanship, nor do I wish to condemn it. I merely wish to warn readers that it is unnecessary and that there will be less weight and repair work if a wing is constructed on simple and well-thought-out lines. Flying results will also be better.

Let us see what we can do to simplify matters and produce wings that will suffer the minimum of damage in the event of rough landings and crashes, which will surely occur from time to time with a flying model. Except in very small models, we first require a wing that is detachable in the centre. This makes for ease of transport, and the wing will not fracture so easily if it hits some obstacle during flight when the two wing halves are held together by resilient elastic bands and also if the complete assembly is held to the fuselage by rubber bands.

Secondly, when a high-wing model turns on to its back on landing, as it will do sometime during its lifetime, all the weight of the model rests on the tops of the two wing tips owing to the dihedral angle. Therefore our "split" wing must be able to give at the central joint without damage. If we fit rigid and long dowels that peg in from one wing-half to the other, as is often done, something must fracture. Either the dowels break off or the wing collapses at the dowel holes. Therefore we should fit only short, stubby locating dowels of about $\frac{1}{2}$ in. or so in length and design our keeper hooks and the wing platform so that sufficient support is given to the rubber bands to keep the wings rigid against air pressure and yet give, in the event of a sudden blow. This can be done, as the reader will see, by studying the series of wing construction photographs given later in this chapter. The leading edge should be of box formation, because it makes for rigidity and yet is light. The trailing edge, which is subject to distortion, can very easily be made strong and rigid by the method shown later.

The Drawing

Before we start construction, it is necessary to break off for a moment to describe how to make our full-sized drawing, as we did in the case of the fuselage. In Chapter V we discussed wing shapes and many readers will wish to construct either tapered wings (it is hoped with the trailing edge sweeping forward. See Chapter V) or elliptical wings.

Fig. 65 shows how to make a full-sized drawing of either a tapered or elliptical wing. There is no difficulty about drawing a constant-chord wing. Over this drawing,

Fig. 64. A complicated, but interesting, wing. The trailing edge is weak.



FIG 65

METHOD OF DRAWING OUT A TAPERED WING
& RIBS ALSO APPLICABLE TO ELLIPTICAL WING

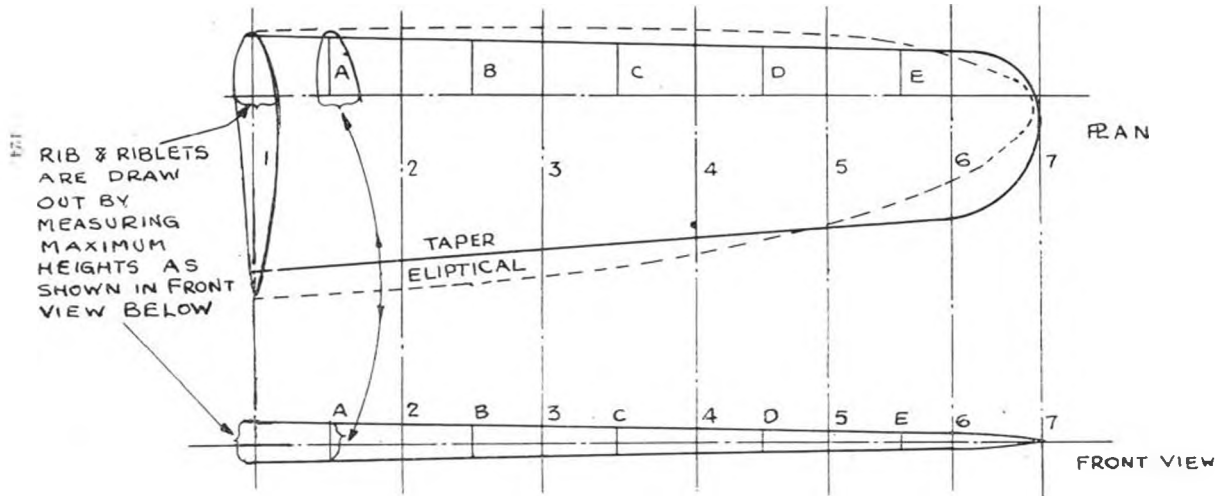

which again we can make cheaply on kitchen paper, we build our wing.

A Building Board

Having made the drawing, we want something to build upon. It can be done on the kitchen table if the constructor is allowed the use of this piece of furniture, but it will be far easier if a special wing-building board is

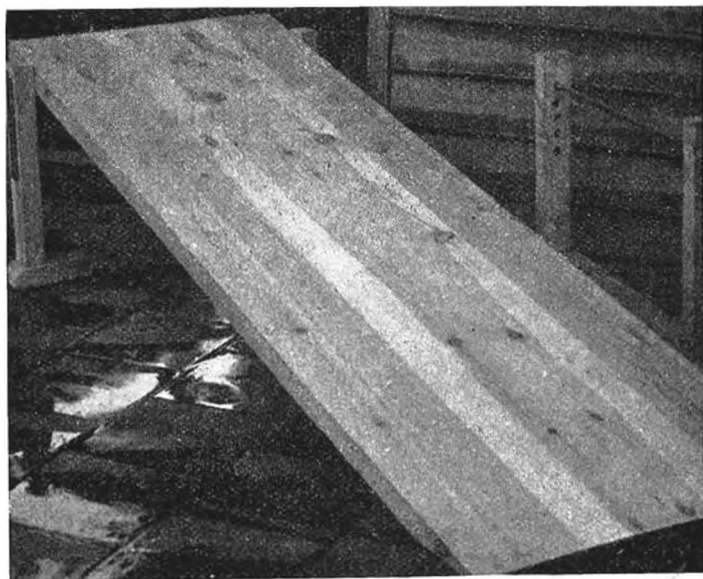

Fig. 66. Building board for wings with adjustable dihedral rise at the end.

made. In Fig. 66 is shown one-half of the board that I use. It will be observed that there is an adjustable end with a rod and thumbscrew that can be placed at different heights to suit varying dihedral angles. This board is large enough to build any wing up to 10-ft. span and if desired can have a hinge at the centre.

Cutting the Ribs

We now trace out the rib shapes on to sheet balsa, $\frac{1}{16}$ in. thick for small models and $\frac{1}{8}$ in. thick for larger models. The ribs can then be cut with a razor blade or a treadle fret saw, if available.

Construction

The next stage, as in the case of the fuselage, is to pin the full-sized drawing down to the building board with a covering of transparent greaseproof paper to prevent glue sticking to the drawing. We then build the outline of the wing on to this. See Fig. 67.

Let us look at Fig. 68. This is a simple parallel chord wing. It is the left half and is 2 ft. 6 in. long. The ribs are cut from light-weight $\frac{1}{8}$ -in. thick balsa sheet. The riblets from $\frac{1}{16}$ -in. sheet.

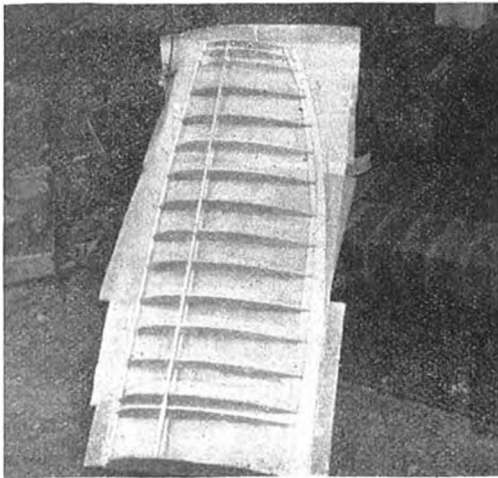

Fig. 67. The wing is commenced on a full-sized drawing covered with greaseproof paper.

The leading edge (L.E.) is $\frac{1}{16}$ -in. \times $\frac{1}{16}$ -in. balsa and later a covering of light $\frac{1}{16}$ -in. balsa sheet is given from the two mainspars ($\frac{1}{8}$ -in. \times $\frac{1}{8}$ -in. birch or $\frac{1}{16}$ -in. \times $\frac{1}{16}$ -in. hard balsa) to the L.E. both top and bottom, thus forming a strong but light box spar at the nose of the wing.

The wing tips are made from a sheet-balsa outline of $\frac{1}{4}$ -in. thick sheet. The trailing edge is made from a $\frac{1}{4}$ -in. \times $\frac{1}{8}$ -in. hard balsa spar, and, *most important*, in order to eliminate distortion, a 1-in. wide balsa strip of sheet $\frac{1}{16}$ in. thick is glued along the bottom of the T.E. spar, with blobs of glue touching the main ribs where they joined this reinforcing strip.

It is often a good plan to glue on a similar top reinforcing strip approximately 1 in. wide. Thus we have a kind of rear box spar to our wing. These reinforcements weigh practically nothing extra, but add enormously to the

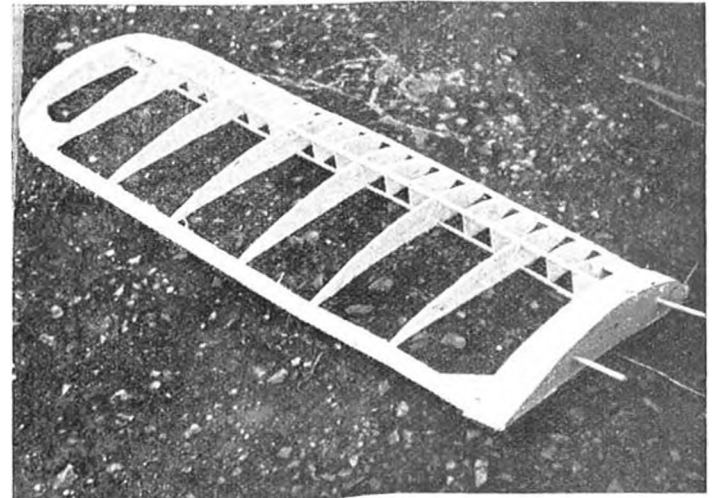

Fig. 68. A simple parallel wing as described in the text. The protruding dowels are too long and suffered damage.

torsional stiffness of the wing and are very easy to construct and repair. I have built wings up to 10-ft. span on these lines. These vital reinforcing strips can be seen more clearly in Fig. 75 if the reader will turn on a few pages.

Now reinforce the centre section with a $\frac{1}{8}$ -in. balsa sheet covering top and bottom. This adds to strength and trueness, and makes a firmer base for the wing to rest on its wing platform; it also assists in ease of covering with silk. All sheet-balsa covering can be done by sticking in dres making pins until the glue has set. That is the beauty of working with balsa; pins stick in the wood so easily. Before we cover the centre section with its sheet, we must make and fix our wire hooks for the retaining rubber bands for both wing halves and we must put in out short stubby locating dowels into one wing half.

Fig. 69 shows a tapered wing in the course of construction, and with the front balsa-sheet covering put on, also the centre section covering of thin three-ply or balsa sheet. This wing was of 8-ft. span and belonged to my old "Blue Dragon" record holder. It is still in flying trim after all these years (since 1933). A very thin 0.8-mm. three-ply covering was used for the centre section instead of $\frac{1}{8}$ -in. sheet balsa in this case. The dowel-locating holes can be seen on the right wing half. The dowel locators were on the left half of the wing.

Elliptical Wing

Although I construct my large-size elliptical wings as already described, with a wide trailing edge cut from thick balsa sheet and with a reinforcing strip below, I have used a simplified and very satisfactory method for smaller models up to 5-ft. span. Incidentally, this method is also satisfactory for rubber-driven models with elliptical wings. It overcomes all the difficulties I have seen mentioned by some writers on this subject, and it is practically

impossible for warping to set in once it is properly covered and doped.

The outline of L.E. and T.E. are cut in $\frac{1}{8}$ -in. sheet balsa approximately 1 in. wide. The balsa ribs are then glued in place on to this outline. Balsa lengths $\frac{1}{2}$ in. \times $\frac{1}{8}$ in. are next glued at nose and T.E. after being soaked in hot water for half an hour. These are pinned into position and are left to dry thoroughly overnight. The next day a similar T.E. outline about 1 in. wide of $\frac{1}{8}$ -in.

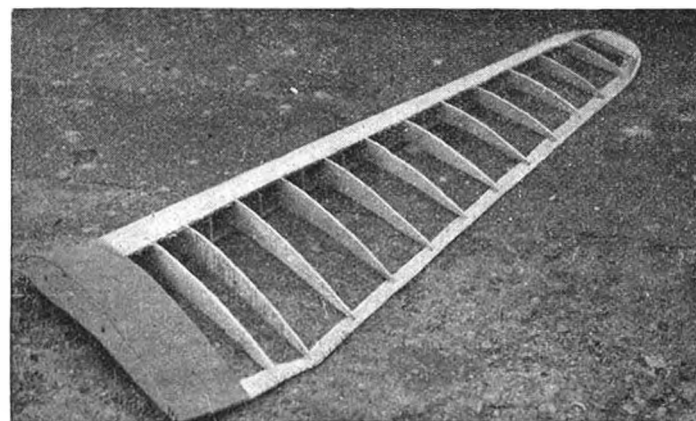

Fig. 69. A tapered wing with the sheet balsa nose covering in position. This is an 8-ft. span wing.

sheet is glued *on top* of the T.E. After the T.E. spar has been shaved down to a knife edge, the leading edge is now covered on top with $\frac{1}{8}$ -in. balsa sheet approximately to one-quarter of the chord. There are therefore no main spars, but a strong shell leading edge and trailing edge which, due to the curved elliptical shape fore and aft, is extremely rigid. The construction is also very light indeed. Fig. 70 shows the completed wing for a small model. It is fitted with wing-tip slots.

Small Wings

Figs. 71 and 72 show an elliptical wing made for a baby high-wing model. The model is described in Chapter XII.

Fig. 71 shows the wing partly completed, with its wire hooks bound to spars with thread and glued into position, and *with balsa plastic wood put in to reinforce where the hooks come*. The short stubby locating dowels can be seen.

The completed wing before silk covering can be seen

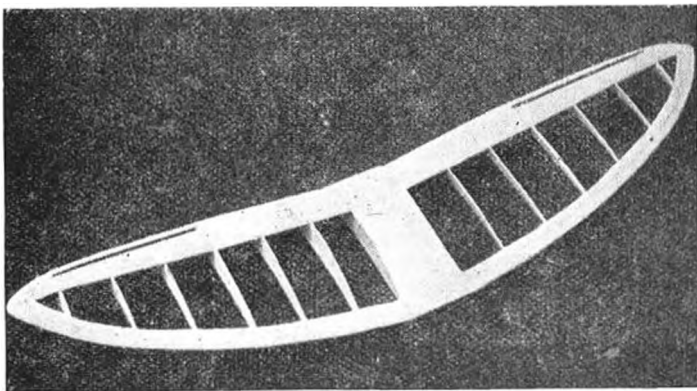

Fig. 70. The elliptical wing without spars is now covered with its top sheet balsa. The wing-tip slots can be seen clearly. The $\frac{1}{8}$ in. x $\frac{1}{8}$ in. balsa strip trailing edge cemented on to an outline of $\frac{1}{16}$ in. sheet balsa is then covered with a second outline of sheet balsa on top, thus providing a "V"-shaped trailing edge of great lightness and strength.

in Fig. 72. The nose sheet covering and the top centre section covering are now on and the trailing edge reinforcing balsa sheet strip that I advocate is glued into position below the T.E. spar

The temporary pins retaining the sheet covering can be seen. These were removed when the glue set and the sheet covering the edges were then cleaned up with a razor blade.

The whole wing was then sandpapered smooth, and

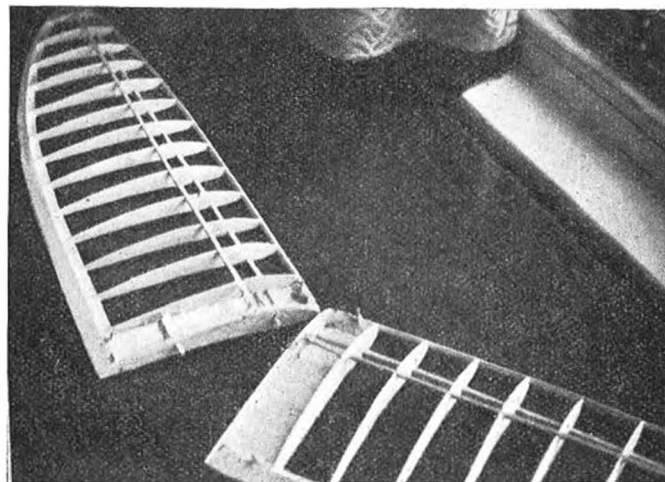
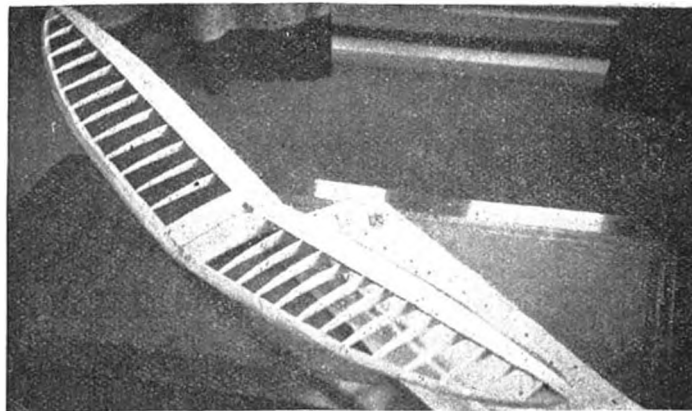

Fig. 71. A small elliptical wing, partly completed. The short stubby locating dowels can be seen . . . also reinforcing plastic balsa.

afterwards covered with silk (see instructions at the end of this chapter). Fig. 73 gives an idea of a large 10-ft. span wing I constructed on the simple lines described. The

Fig. 72. The wing is now completed except for covering with silk and taking out the pins on the right-hand wing half.



chord is $21\frac{1}{2}$ in. at the centre. In spite of its size, the whole structure is very strong and rigid. There are no cross-bracing spars.

Wing Tips

Wing tips may be made integral with the wing, as

Fig. 73. The author's 10-ft. span elliptical wing, shown beside a 6-ft. man. This wing was constructed on the simple lines described, and has no cross-bracing struts. Rigidity is obtained through the balsa leading edge covering the special trailing edge, and the doped silk.

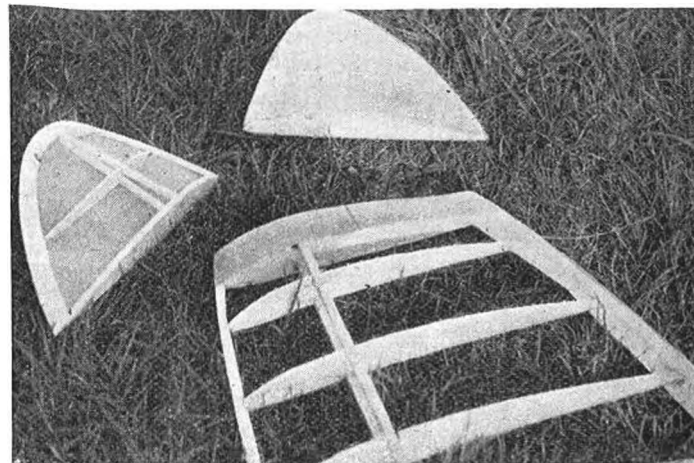

Fig. 74. The construction of a detachable wing tip, completely sheeted over.

already described, or may be made as a separate unit and glued and pegged on separately. The latter method has the advantage that a small extra tip dihedral may be given, and it can be altered later by slicing off the stuck-on tip and re-attaching at a greater or lesser angle.

If the reader will study Fig. 74, he will see a detachable tip made for an 8-ft. span semi-scale monocoque low-wing model. This slight extra dihedral tip allows one to give a low-wing model a more realistic dihedral in the centre that is not excessive. The dihedral tips have considerable leverage effect in the air, being situated well away from the C.G., and yet tips need not be given a large angle, which would spoil the appearance. How to build the model in question is described in Chapter XII.

Wing tips which are strong but light can be constructed of laminated balsa sheet, bent piano wire or steamed birch-wood. The laminated-type tip is extremely durable and strong, and on larger models is the best type for standing up to rough handling.

Low Wings

On most of my low-wing models I arrange the wing to be held to a platform at the bottom of the fuselage by rubber bands or other forms of elastic retainers. This is a simple method and prevents damage in the event of a crash.

Dr. Forster has devised an excellent system giving the same advantages. I will describe this shortly.

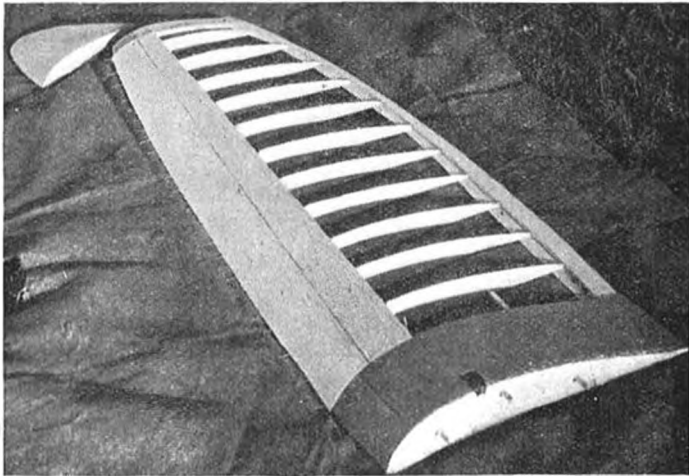

Fig. 75. A low wing, as described in the text, can be seen under construction. Note the temporary pins whilst the glue is setting, also the trailing edge reinforcing strip.

In the meantime, let us turn to alterations in detail construction necessary to make the type of wing that I have been describing suit its low-wing position. Because we cannot have external wire hooks for the rubber bands protruding from the top of the wing, as the top has to fit up snugly to the bottom of the fuselage, we must have our top retaining hooks slightly below the top centre section covering. This means a small portion must be cut away in order to thread on the rubber bands. The

wire hook is bound to the bottom of the top spar. See Fig. 75. I usually fit three short locating dowels on the low wing. These can also be seen in Fig. 75. Incidentally, the dressmaking pins, to keep the nose covering of sheet balsa in position, can be seen clearly in this view of the partially completed wing half. The trailing edge reinforcing strip is seen clearly in this photograph, whilst the detachable wing tip can also be seen.

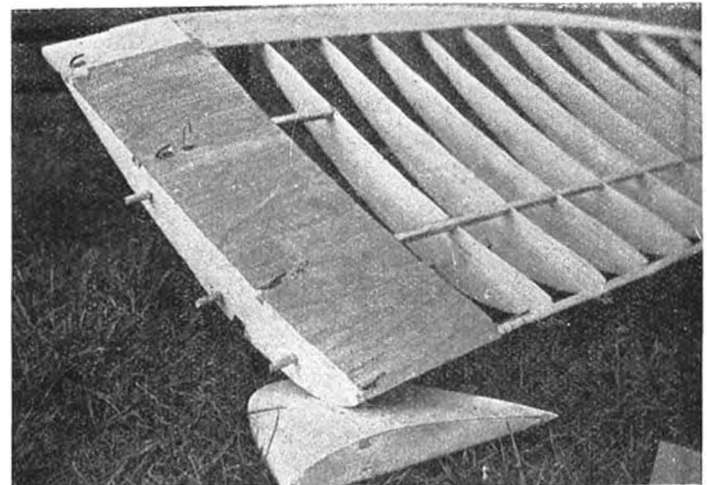
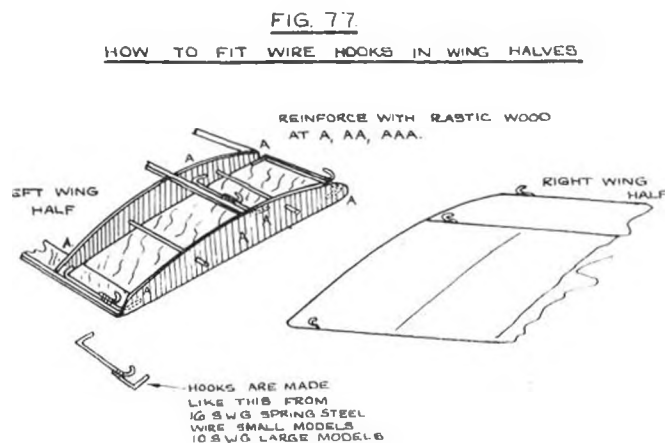

Fig. 76. The wire hooks for rubber bands can be seen in this photograph. (See this chapter.)

In Fig. 76 the reader will be able to see the stout wire hooks for rubber bands which are fitted at L.E. and T.E. Also, in this case, as it is a low wing and takes the flying load from below, there are two hooks located, one at the main spar position and one further back. The two little additional hooks of thin wire at these central positions are to keep the battery and timer-clock carrier in position by rubber bands, as described in Chapter IV. The three stiff and stubby little locating dowels are quite clear in

this photograph. How to construct the wire hooks is shown in Fig. 77.



Constructing Wing-tip Slots

In Chapter V, on stability, I discussed the advantages of fitting wing-tip slots and in Chapter X a design to build a small model with these slots is given.

If the reader will study Fig. 78, he will see how my type of in-built slots can be carved from balsa wood to the shape shown in Chapter V and glued on to the leading edge spar, which is left bare where the slot is to be located. The slot is then covered with silk at the same time as the rest of the wing is covered, leaving the openings free, of course, for the air to flow through.

Wing Platforms

A high wing platform upon which to rest the wing may be shaped to a V-angle (i.e. the dihedral angle is started from the centre of the wing). The wing will not then tend to slip from side to side, nor slew round so easily. As a result the rubber retaining bands need not

be so thick, and therefore will operate more easily as shock absorbers in the event of a crash.

External wire hooks for the rubber bands can be fitted if looks are not considered of paramount importance. The rubber bands are then got at easily and quickly for replacements. Various methods of concealing these holding-down rubber bands have been devised, and will no doubt also be desired by the reader, but it must be admitted that most of the methods make quick operation more difficult.

In Chapter XIV a method is described as used on one

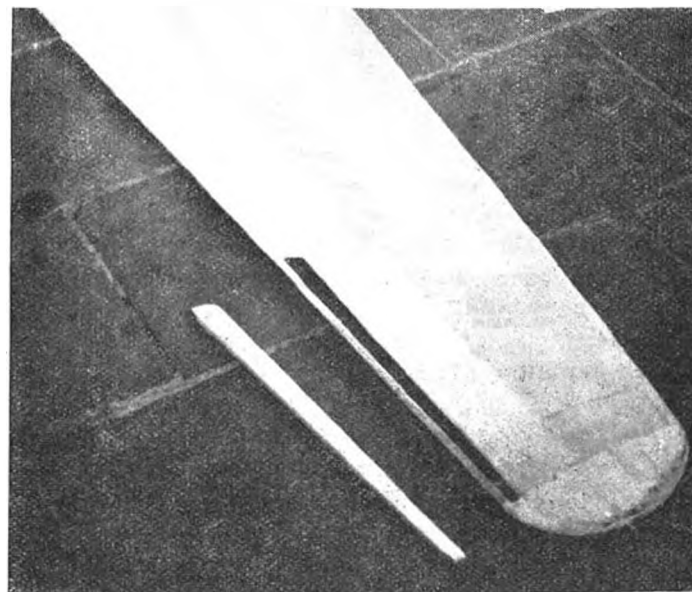
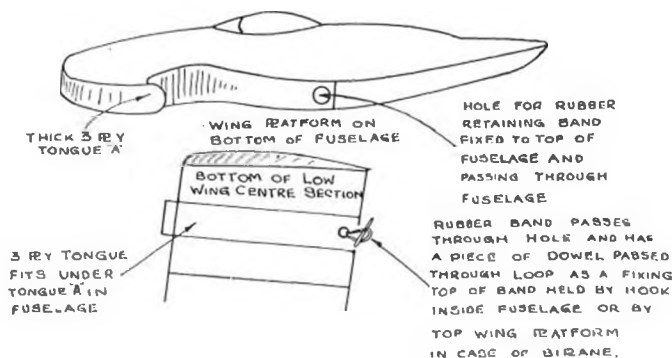

Fig. 78. The Bowden type of wing-tip slot, carved from thick balsa sheet. It is then glued on to the leading edge spar and later covered with silk and doped.

of my low-wing models for holding up a split low wing to the fuselage by broad garter elastic. This is an unobtrusive

FIG 79

LOW WING AND BIRANE LOWER WING FIXING BY
RUBBER BANDS FOR SMALL MODELS



method. But undoubtedly the most practical way is the simple and well-tried external hook method as used on my high-wing models. A simple method is described in Fig. 79 for small low-wing models, or for the mounting of the lower plane of a biplane, in which the retaining rubber is hidden.

It is often a good plan to glue a covering of emery paper as an anti-slip device to the wing platform.

Dr. Forster's Low-wing Mounting

A very neat type of mounting is that designed by Dr. Forster. It works very well in practice and I have seen his model fly many times without damage. The general principles are shown in Fig. 80. The wing halves knock out backwards from the pivot tongues and the rubber retaining bands are housed inside the fuselage. This necessitates a hatch to get at these bands from the top. The same principle can be adapted to high wing mounting. The method looks very neat but requires rather good workmanship for a novice.

FIG 80.

DR. FORSTER'S LOW WING MOUNTING
THIS MOUNTING CAN BE ADAPTED TO A HIGH WING MODEL.

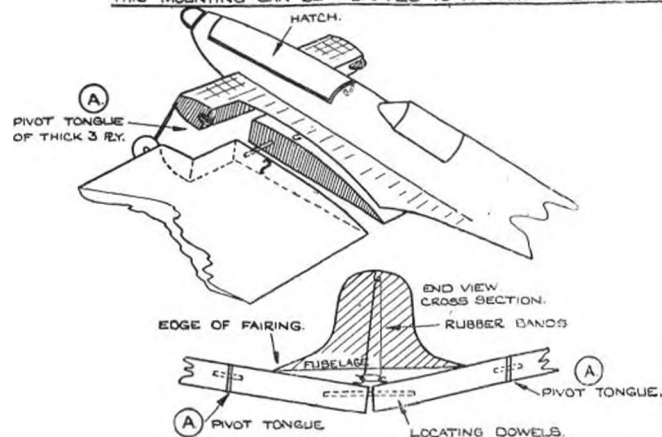

The Tailplane and Fin

A detachable tail and a detachable fin (rudder) are advisable on a medium size or large model. The tail end of a petrol model often receives fairly severe blows. Should the model fly into a tree, it may, during subsequent rescue, fall from a height to the ground. This usually causes some damage to the tail and fin, and also to the rear of the fuselage, if these components are built in rigidly. Fig. 81, sub-figure (1), shows the general principle upon which detachable units held on by rubber bands may be constructed. There are many variations of this system, but the principle is the same. Fig. 82 depicts the method I have evolved for constructing a detachable fin made up by laminations of balsa wood. The finished fin is quite light, does not distort, and makes the model very portable.

If the reader will refer to Fig. 81, sub-figure (2), he will see how a light and simple tail and fin, built into one unit, may be made which will plug into the fuselage.

have found that, although this method looks nice, it is not very satisfactory on a large model. It is, however, quite suitable for baby models.

The fixing of a detachable tail unit may be carried out in a number of ways. The hook and rubber band method shown in my sketches has proved very satisfactory from

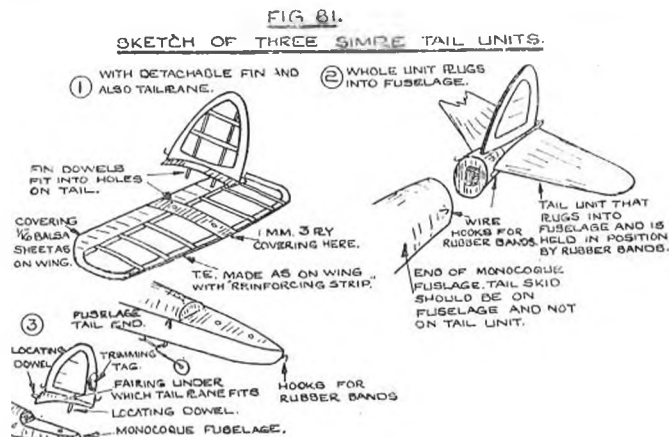

the practical angle, although the external rubber bands appear rather unsightly. Some people use wire saddles, with hooks for rubber bands; others locate tubes in the fuselage at the leading edge end of the tailplane, with wire prongs on the tailplane fitting into the tubes, whilst hooks are arranged at the rear for rubber bands. Others fit long bolts to the fin and pass these through the tailplane and fuselage and draw the whole up tight with thumb screws. This method looks well, but is far too rigid for me. I often use wooden dowels fixed across and through the fuselage in lieu of wire hooks, or a hook on the fin leading edge, from which a rubber band passes through the fuselage to an internal hook inside the fuselage. The rubber band is thus almost concealed and the tailplane is kept down in position by the fin. There

must be an external hook at the T.E. end of the fin and another at the tail end of the fuselage.

Covering the Model

Medium size and large models are best covered with silk. Even monocoque-planked and sheet-covered fuselages are far stronger and have a longer life if covered with silk. Plenty of photo-paste or "Grip Fix" should be smeared on to the balsa sheet or planks and the silk then worked in taut by the fingers.

FIG 82
METHOD OF CONSTRUCTING A FIN THAT WILL NOT WARP
(SEE FIG 12)

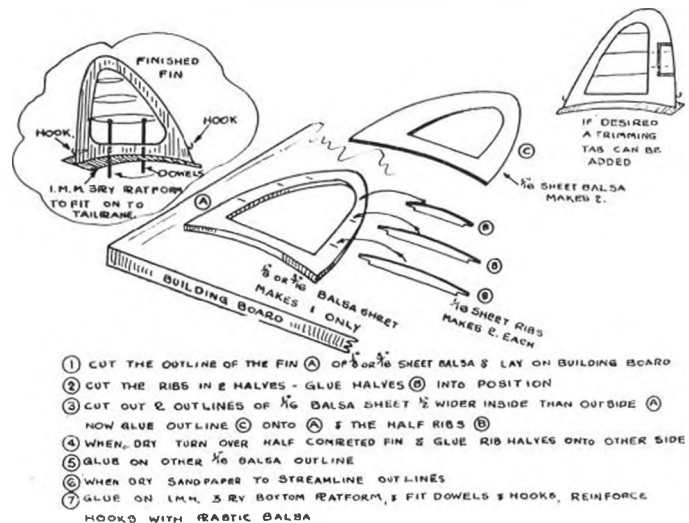

Baby models can be covered with bamboo paper with success, although thin Jap silk is not much heavier and certainly stronger.

Covering is an art, and usually the beginner falls down on this. Actually, it is quite a simple art, but it requires a knowledge of certain simple facts and then a little practice. A very important point is the *use of the correct dope for petrol models*. This is explained below under the heading "Doping." Photopaste or "Grip-Fix" makes the best adhesive for covering when using silk or paper, because if a mistake is made water softens it.

Smear the paste upon the outline to be covered, then put on the silk or paper, with the grain running along a fuselage or a fin and across a wing or tailplane. Draw reasonably tight, but do not stretch. Now trim around edges with sharp scissors, spray with water from a scent or other type of spray, so that the silk is damp. Carefully but quickly stretch the silk so that there are just no wrinkles. *Be very careful not to over-stretch*. This is where so many people go wrong. When the water dries the silk will draw up. Stick down the edges with photopaste and allow the damp silk to dry. As it dries it tautens, and if the stretching by hand has been done easily and *lightly* the silk will tighten without a wrinkle. If the silk has been over-stretched by hand it will warp the framework when it dries and is doped.

Should there be a badly-covered section, this section can be sprayed with water again and because we have used photopaste we can unstick the edges, re-stretch the silk and allow to dry, when all wrinkles will have disappeared. When covering wings with under camber, cover the bottom first and stitch the silk around the ribs to retain this under camber. A little practice on these lines will produce first-class results. When the silk has quite dried, dope is applied. Covering with bamboo paper is similar, except that the paper should be placed on reasonably taut *before* spraying with water. The water will again take up the wrinkles. *Do not over-tauten*. Light hands are required for good covering!

Nylon makes a first class covering. Photo-paste is used as an adhesive, and the procedure is then exactly the same as for silk. Nylon takes longer to harden. The surfaces must therefore be weighted down to a flat board for several days to prevent distortion.

Doping

Like covering, there are a few simple hints about doping a petrol model that make all the difference between success or failure. We require a model with a fairly waterproof finish, and one that will not slack off its silk in damp weather.

It is a great mistake to dope a petrol model with a number of coats of thin model dope. A good finish is seldom obtained and a slacking off of the fabric will take place in damp weather, which will ruin the rigidity and trim of the model.

The builder should take care that he obtains real, *full-strength*, clear glider dope. Some model shops only sell thin dope for petrol work, others occasionally sell what they call "petrol model dope," but it is not the genuine full-strength stuff. It is therefore advisable to buy dope for petrol models from well-known firms that specialise in, and cater for, the petrol man.

A fairly soft-haired, square-ended brush is the best to use and only one coat of the full-strength dope need usually be applied. Flow it thickly and quickly on to the silk and do not "work" it too much or the silk will be stretched and strained in patches. If this full-strength dope is put on fairly thickly, it will fill the pores of the silk and make a really good, strong surface, ready to withstand a deal of rough handling.

Be careful to weight down edges of wings, etc., to flat building boards whilst the dope is drying and setting. A wing, tail or fuselage which has been allowed to dry true in a warm

room for 24 hours will remain set in its true shape for very long periods, provided that it has been doped copiously, as described, with full-strength, clear glider dope. Coloured dopes can be obtained, but usually finish with a rather matt appearance. If I require a glossy finish, I give a coat of glossy paint over the "clear" doped surfaces. Unfortunately, paint weighs heavily and therefore can only be used with success on larger models or those with a light wing loading. When the dope is drying on a wing, a slip of wood should be inserted below the tip trailing edge, so that a slight "washout" or negative angle is given to the wing tip. This is explained in the chapter on stability.

Scale of Comparative Weights of Wood

The following table may be of use to designers when considering their models.

Wood	Oz. weight per cu. ft.	Weight compared with balsa
Balsa	0.075	—
Obeechi	0.174	2.3 times as heavy
Spruce	0.317	4.2 " "
Cedar	0.358	4.69 " "
Walnut	0.387	5.16 " "
Birch	0.420	5.60 " "
Ash	0.486	6.48 " "
Beech	0.491	6.54 " "

Tools and Their Use

The reader has now absorbed descriptions of how to construct the various components of a petrol model and, if he happens to be a newcomer to model building, he

may have wondered what tools he will require for building. It is possible to construct a petrol model with very few tools, as some of us have discovered during the days of war, when the contents of our workshop have been packed up and stored.

The rather ambitious, semi-scale low-wing monocoque model seen in Chapter XII was built on top of a large three-ply wooden model box, and made with the following equipment: A long ruler and simple drawing instruments, kitchen paper, carbon and greaseproof paper,

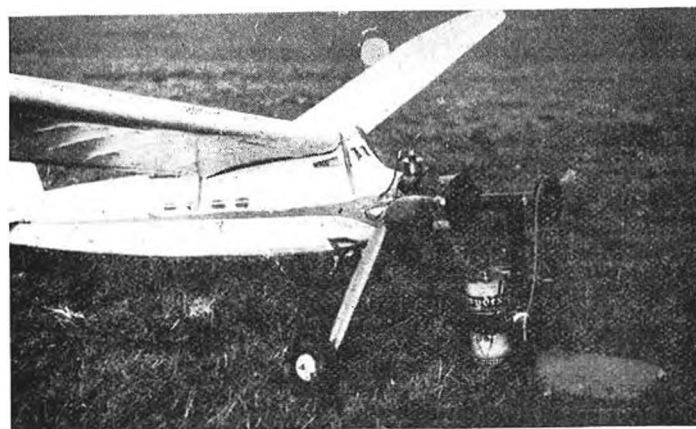

Fig. 83. An engine starter produced by the author. The tubular column is quickly adjustable for height, and the pulley for starting cord is fitted with a free-wheel ratchet.

razor blades of the single cutting edge type for balsa wood work, sandpaper (coarse and fine), hand fretsaw to cut three-ply nose piece, etc., pocket knife to work plastic wood, helped by the fingers, dope brush, paint brush, lining brush, binding thread and wire, hand brace and drills, pliers, wire cutters to cut piano wire, file to cut brass tubes, electric soldering iron or pocket methylated soldering outfit, and several packets of pins.

Materials

A quart or half-gallon tin of glider dope, cellulose paint, large quantities of quick-drying glue, plentiful supply of photopaste, wire, balsa wood, three-ply wood, silk and plastic wood.

The Workshop

Tools like a treadle, or power-driven fretsaw, a hacksaw, a lathe, wood gouges, vice, and a host of other instruments, including wing building board, are luxuries with which the petrol man will eventually equip himself according to his means. They are, however, not necessities.

Engine-starting Devices

The most popular method is to swing the propeller by hand. One device put on the market consisted of a coil spring inside a tube, with rubber-covered prongs to engage the propeller. The spring was wound up and released to start the engine.

In the early days I produced a portable starter with booster battery complete. The details can be seen in Fig. 83.

I came to the conclusion that these starters were a luxury and made unnecessary paraphernalia to carry about, and were therefore not necessary.

CHAPTER VIII

THE MIDGET MODEL

THERE is great fascination in the idea of producing a baby petrol model that can be packed up in a suitcase with one's lunch and a bottle of beer! The suitcase can be carried on a push-bicycle, a bus, or slung in the back of a car, whereas the larger model usually takes up most of the spare room in a car, often much to the annoyance of one's fair friends.

Unfortunately, the baby model is not so easy to design and operate as the larger model. The limiting factor is the engine power for its weight, and particularly for the weight of the ignition gear. The little engines, plus their ignition, are rather heavy for their power output. The midget engines, too, are not as yet such consistent starters or performers as their larger brothers. They require more humouring and more experience of the whims of model engines. Engines of $1\frac{1}{2}$ - to 2.5 c.c. are commercially obtainable, weighing from 2 to 3 ozs. bare, but the following must be added to the engine weight: Coil $1\frac{3}{4}$ ozs., condenser $\frac{1}{2}$ oz., timer $1\frac{1}{2}$ ozs., flight battery 4 ozs. or baby accumulator $1\frac{3}{4}$ to $2\frac{1}{2}$ ozs., wiring $\frac{1}{2}$ to 1 oz. I have spent a great deal of time experimenting with the baby model and I have come to certain conclusions which may be of help when the aero-modellist is considering building his first midget.

There are two ways of setting about the project. The first is to make a really tiny machine of about 35 to 40 in. span and built as lightly as possible. See Fig. 84, which shows a simple baby I built some years ago. This type

of model must have a rather heavy wing loading, due to the weight of the engine and ignition gear which the wing has to fly. The model will therefore be fast, touchy and usually does not have a very good glide. It is also prone to damage, but nevertheless a great deal of fun can be obtained from it.

The second way of tackling the problem is to produce a model constructed as lightly as possible, but larger and therefore with a light wing loading in the form of a

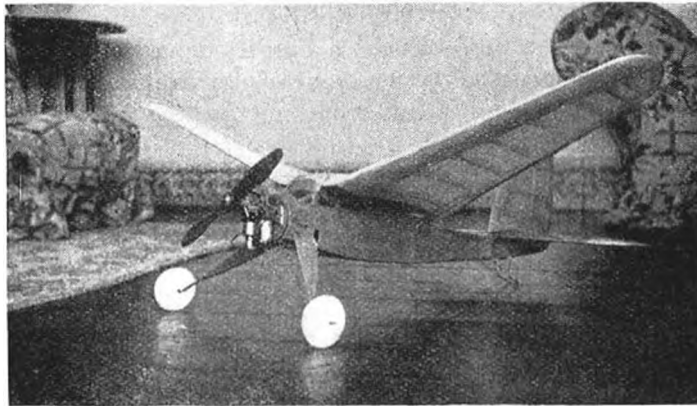

Fig. 84. A baby model of 35-in. span built by the author and fitted with a "Trojan" engine.

powered glider. If head resistance is cut down to a minimum and a wing section with the minimum of drag is used, *very little power is required to fly the model*, which is "what the doctor ordered" for the midget engine.

Generally speaking, I favour the second scheme, as more reliable flying is obtained and the risk of damage is almost entirely eliminated, for a good glide is also obtained. Unfortunately, the suitcase inevitably becomes a little larger and the amount of refreshment that can be carried is naturally reduced!

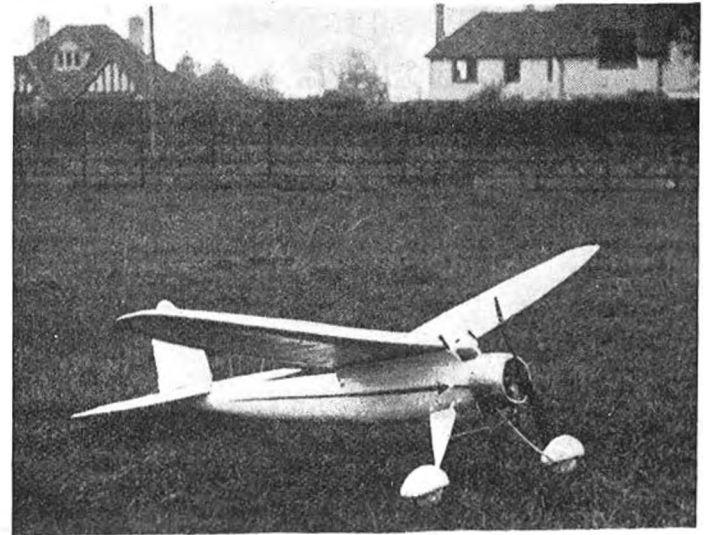
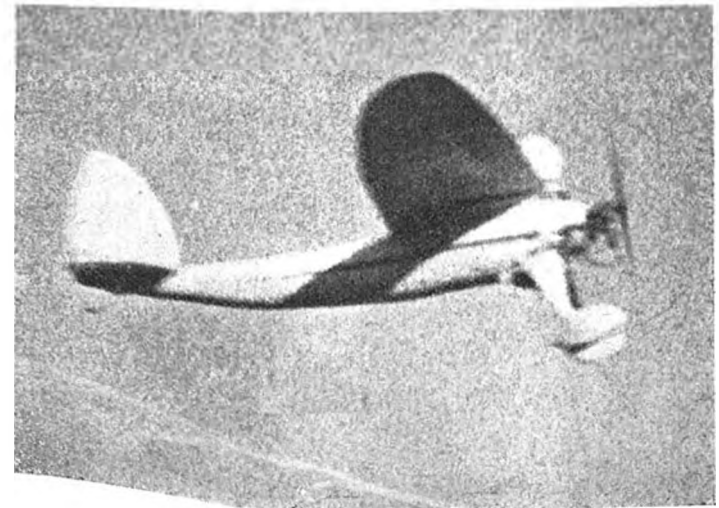

Fig. 85. A little monocoque model built by the author. Constructional details are given in Chapter XII.

Fig. 86. The author's small monocoque model in flight, powered by 2.4 c.c. "Elf" engine.



If the model is carefully designed, however, it is surprising into what a small space it can be packed. This is where the elliptical wing comes in very conveniently, as quite a large wing centre chord can be used with a short span, and when the wing is made in two halves the overall length is quite short. Figs. 85 and 86 show a model of mine which is a beautiful glider and slow flyer, with a span of 4 ft. 4 in. and an 11-in. central chord (elliptical wing). This means wing halves of $25\frac{1}{2}$ in. only. The instructions to construct this model are given in Chapter XI.

If battery ignition is to be used, it is worth while using a 4-volt 4-oz. flash-lamp battery, in spite of its weight, as the baby type of engine likes a good fat spark. A baby accumulator of about $2\frac{1}{2}$ ozs., as described in Chapter IV, is better still. Some people fly on "pencells." I have done this, but do not find the ignition is too reliable with these. As a result, the engine has off days, and some engines will not even keep firing on these small batteries.

Angles of incidence should be kept fine to reduce drag, and the wing section must not be of the thick type.

Fig. 86A. A small monocoque model built by the author and flown by a $1\frac{1}{2}$ -c.c. "Mills" diesel engine. The model flies very slowly and has a 43-in. span. Centre chord 10 $\frac{1}{4}$ in.—wing tip slots are to be fitted. The fuselage is planked with $\frac{1}{16}$ -in. thick planks.



Fig. 87. The "Porlock Puffin" in flight. It is powered by a 2.4 c.c. "Elf" engine.

The secret of the baby model is a fine-pitch propeller a light wing loading and an aerodynamically clean model.

In Fig. 87 the reader can see a very simple high-aspect ratio model called the "Porlock Puffin" that gave me a great deal of first-class flying with all types of baby engines some years ago. It is so simple that I built it in a few spare evenings.

For great portability, the little biplane "Kangette," which is the result of combined operations, for I designed it and Dr. Forster built it, may interest readers. This baby biplane is fitted with wing-tip slots, and will pack up into a very small week-end suitcase indeed. The engine is a $1\frac{1}{2}$ -c.c. "Mighty Atom."

The fuselage is covered with $\frac{1}{16}$ -in. balsa sheet and the forward decking with the centre section struts attached is

detachable. It is held in position with rubber bands passing through the fuselage and fixed to the lower wing, which pulls up on to a curved seating under the belly of the fuselage. The wings have leading and trailing edges covered with sheet balsa, and *no spars*. There is a greater dihedral angle on the top plane than on the bottom, and the general line-up principles are the same as those described for a biplane in Chapter V. This biplane requires a slightly larger fin than that shown in Fig. 88.

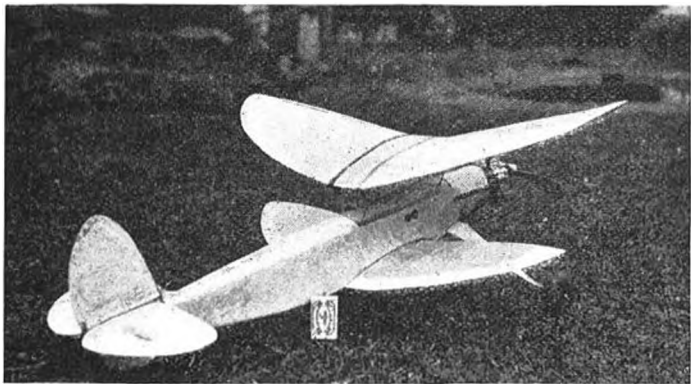

Fig. 88. "Kangette Junior," powered by a $1\frac{1}{2}$ c.c. "Mighty Atom" engine.

Figs. 88 and 89 show the model, the dimensions of which are: Fuselage 26 in. long, 2 in. width; top plane span 32 in.; centre chord 8 in., with 5-in. long wing tip slot; bottom plane $25\frac{1}{2}$ -in. span, 7-in. chord at the centre; ribs are spaced $2\frac{1}{2}$ in. apart.

Dr. Forster has since built a slightly larger "Kangette," also powered by a 1.5-c.c. "Mighty Atom" engine. It is therefore more lightly loaded. The dimensions are: Top wing 36-in. span, $8\frac{1}{2}$ -in. chord (maximum); bottom wing 32-in. span, $7\frac{1}{2}$ -in. chord (maximum); fuselage $26\frac{1}{2}$ in. length, spinner to tail, overall length 29 in.; flying weight $1\frac{3}{4}$ lb.

have also built an even slightly larger version of "Kangette" with a monocoque fuselage engined by a 3-c.c. engine. The dimensions are as follow:—

Top wing span, 44 in., chord 9 in. maximum at centre (elliptical), wing-tip slots $9\frac{1}{2}$ in. long.

Bottom wing, $37\frac{1}{2}$ in., 9 in. maximum at centre (elliptical), wing-tip slots $7\frac{1}{2}$ in. long.



Fig. 89. "Kangette Junior" climbing lustily on $1\frac{1}{2}$ c.c.

Tailplane, span 25 in., chord $7\frac{1}{2}$ in. (elliptical).
Top fin, height $7\frac{1}{4}$ in., chord $7\frac{1}{4}$ in. (maximum).
Fuselage length, 38 in., overall with engine, 41 in.
Engine, "Ohlsson 23" 3 c.c. See Figs. 90 and 91.

One of the smallest practical free-flight models ever produced in this country is Mr. Norman's little 31-in. span monocoque model. It is not merely a stunt, for it

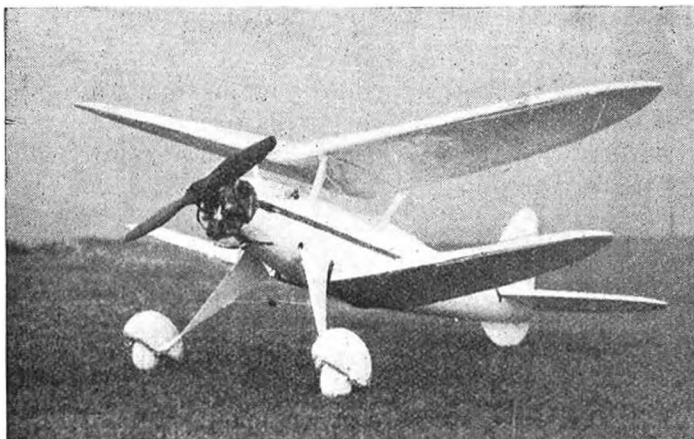
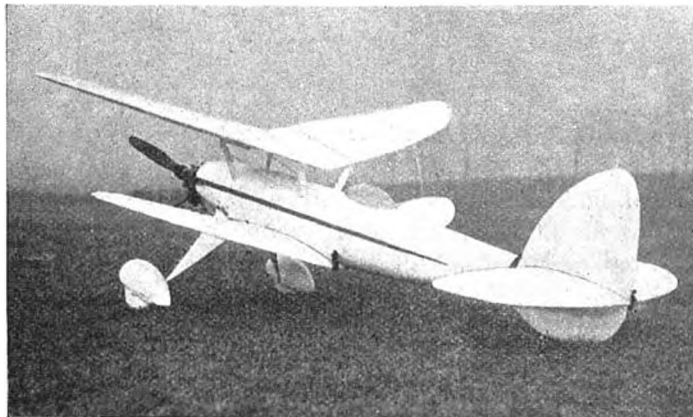

Fig. 90. "Kangette Senior." The author's monocoque baby with 3 c.c. engine.

has flown well, and it has a number of novel but practical features. Its general dimensions and weights are as follow :—

Wing span, 31 in., chord of parallel wing 6 in.
Overall length, 20 in.

Fig. 91. A three-quarter rear view of "Kangette Senior."



Wing area, 180 sq. in.

Propeller, 8½ in. diameter.

Total weight, 13 ozs., made up as follows : Engine 3 ozs., coil 2 ozs., special midget "Norman" accumulator; engine mount 1 oz., condenser ½ oz., wing and tail 2½ ozs., fuselage 2½ ozs.

The model is covered with bamboo paper, and the total weight has increased slightly since building, due to oil saturation and repair work. Wing-tip slots as described in Chapter V are fitted.

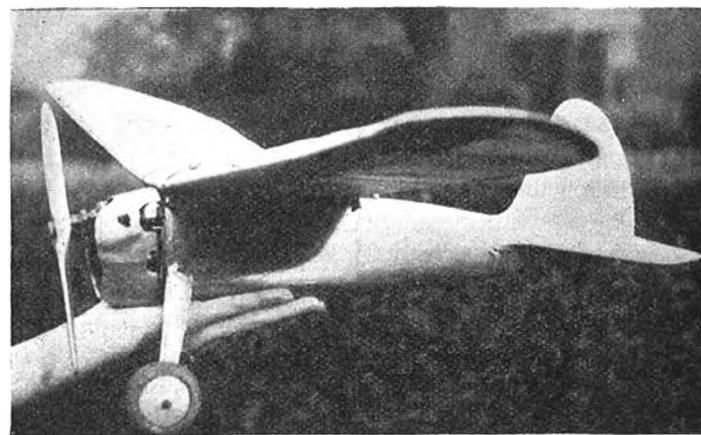

Fig. 92. Mr. Norman's 31-in. span petrol model showing its clean lines and monocoque fuselage. It is fitted with 1.8 c.c. engine

The tail and fin are built into one detachable unit. The fuselage is a monocoque structure of ⅛-in. sheet balsa, only 10½ in. long, into which the tail unit plugs. The fuselage construction is from two pieces of sheet balsa ⅛ in. curved and reinforced where necessary with 1/32-in. plywood and formers at front and rear. The nose has a plywood reinforcement, and a simple wire cantilever undercarriage with plywood fairing. There is a sheet

celluloid-lined carrier in the fuselage for the midget accumulator. The engine is 1.8 c.c. and was made by Mr. Norman. In practice, the fuselage has been found just a little too short, and it is felt that slightly more length would result in improved longitudinal stability. The glide, naturally is not of the floating type. See Fig. 92.

A Final Summary of Advice

If you succumb to the lure of making your first model a very small one, in the 36-in. span class, and you do not obtain satisfactory flying results, for lack of experience in this rather difficult type, do not despair. Try the method of building a slightly larger model around 4 ft. 3 in. to 5 ft. span, of as light a construction as possible, on the powered glider principle. This model will have a light wing loading and the baby engine will have less to do. Those who have built large sailplanes will realise how these machines glide very easily, because of their large wing area. It requires only a very little extra power to make them climb.

The question of using the most suitable battery for flight ignition is so important that I strongly recommend the reader to try his baby engine *out of doors* in the cold atmosphere with different types of flash-lamp batteries that I have mentioned in the chapter on ignition *before* he decides upon his final design for his midget model. He must make his tests with the coil and condenser which are to be used on the model, and I specify "out of doors" because I have known "pencell" batteries give good running indoors but failing to do so when conditions are colder outside. This is, of course, because cold weather makes vaporisation of the oily fuel more difficult, and so necessitates a hotter spark. We must remember that the bulk of days in England are cold. A moment's consideration will convince the reader that his baby model must have all the power available from his midget engine. To

do this, he must have ignition that will produce that power. On some engines this means carrying at least a 4-oz. battery. *In this case, the model will have to be the larger type of powered glider with a large wing surface.*

I advise the preliminary out-of-doors test to be carried out as follows: Start up, and warm up, on the booster battery and obtain full revolutions. Now switch on to the No. 8 pencell battery and disconnect the booster. If the engine runs well for a minute or more on the single No. 8 pencell, well and good. A really midget model can be built for that combination of engine, coil and condenser.

If one No. 8 does not produce even running, try two in series. If this is satisfactory, one will have to face approximately 3 ozs. for battery weight, i.e. a slightly larger model.

If two No. 8s will not produce even and continuous running with full power, then we must produce a model carrying the rectangular 4-oz. 4-volt flash-lamp battery with a wing span of not less than 4 ft. 3 in. to 5 ft.

As this book goes to press, I have recently completed and test-flown with complete success a $\frac{1}{2}$ c.c. diesel engined model of 34 in. span and an elliptical wing. The model weighs 8 $\frac{1}{2}$ oz. complete, and, therefore, has a low wing loading and is very stable. The engine was made by Mr. J. Colyer, and has great power for its size. It weighs 2 oz. complete and means that a normal rubber-type model can be flown by clapping on a tiny engine to the nose.

CHAPTER IX

PROPELLERS

A TRACTOR airscrew is the correct description for the airscrew of the average petrol model, because most models are pulled and not pushed. The word propeller, however, has been practically universally adopted in this country and in America by official circles—including the air services. Commercially-produced model engines of repute have a certain standard of power output with fairly defined limits. It is, therefore, simple to design propellers that are suitable. When engines are built by private constructors, the difference in power output for a given c.c. is often very marked, and as a result special propellers have to be designed.

Except for the baby model, it is not important that the last ounce of efficiency from the propeller shall be extracted. There are no Air Ministry tests that have to be passed by the model and there is no pay load to worry about. The petrol man is really concerned with one main object—namely to get his model into the air and keep it flying reasonably lustily for one or two minutes, until the timing device switches off the engine to terminate the flight.

The petrol model, therefore, can usually afford to waste a certain amount of power, whereas the rubber-driven duration model must give nothing away if it is to be a success. *Nevertheless, an approximately correct-pitched propeller of the correct diameter and blade area must be fitted or the model will not fly efficiently.* An incorrect pitch will cause excessive drag, which in turn will cause excessive torque, and this tends to upset lateral stability.

Correct R.P.M.

The power output of the internal combustion engine is very much governed by finding its best engine revolutions per minute and then producing a suitable propeller for these revolutions, *so that the blades are not stalled.* The average speed that the modern little aero engine runs at underload, is between 3,000 and 6,000 r.p.m. The diesel engine produces its best power at 2,500 to 3,500 r.p.m.

The Propeller's Action and its Pitch

The blades of a propeller are so shaped that, as they revolve, they screw themselves forward into the air, pulling the model behind them. The angle at which the blades are set determines what is known as "pitch," and this is the theoretical forward distance of travel in one complete revolution. A certain amount of slip takes place owing to the air not being a solid substance, and therefore the propeller travels forward less than the theoretical pitch. This is somewhere about 25 per cent.

The Pitch of the Propeller

The blade of a propeller is akin to a revolving airfoil, or wing, and it is best to think of it as such. It will then be appreciated that, if the blade is revolved at too great an angle of incidence for the forward speed of the model, the blade—or airfoil—will stall, just in the same way as a wing. The airflow will break down, and the thrust will be seriously reduced. This is why modern full-sized aircraft are fitted with variable pitch propellers to suit the slow-flying and high speed flying variations of the machine. Thus, at the take-off, when the aeroplane is flying comparatively slowly, the blades are set at a low pitch or angle of incidence. As the speed mounts, the pitch, or angle of incidence, is automatically increased.

When, for the sake of simplicity in operation and construction, we use a fixed-pitch propeller on our petrol models, we must obviously choose a low- or fine-pitched propeller for a slow-flying model of light wing loading and a coarser pitch for a fast-flying model with high wing loading. Baby petrol models with limited horse power are usually best suited by a fine-pitch propeller. The baby model is definitely touchy on the matter of diameter and pitch.

I am including a simple table which gives approximate diameters and pitches for different engine cubic capacities and sizes of models. This table is based on experience, but it must be appreciated that models of any given size vary a great deal in head resistance, due to their design and finish, and that different engines of the same c.c. may vary somewhat in power output.

Therefore, my table can only be an *approximate guide*. See Fig. 93.

Personally, I favour a propeller with a $\frac{1}{2}$ pitch on the fine side for a petrol model. This gives a greater thrust at the low forward speed of the take-off and the climb, which is the most important part of the flight for the petrol model.

Forward Speed of Model

It is worth summarising this important matter of pitch. At the beginning of a flight, when the model is moving slowly over the ground, the forward speed is very low, and also when the model is climbing steeply. Therefore a fine pitch is required, i.e. a fine angle of incidence of the propeller blades to prevent stalling of the blades.

A lightly-loaded model flies slowly; the flying speed is very little greater than the take-off. We can, therefore, use a fairly fine pitch for both take-off and flying on this type of model, and I will once again remind the reader that it is the best type of model for general-purpose flying.

A heavily-loaded model has a considerable speed to gain before it becomes airborne, and therefore, unless we hand launch or use a variable-pitch propeller, a considerable problem arises in obtaining the correct compromise of pitch for the initial slow forward speed of the take-off and the high speed of flight.

FIG. 93.

PROPELLOR TABLE OF SIZES & PITCHES
APPROXIMATE.

N ^o	APPROX. ENGINE C. C.	APPROX. R. P. M.	PROP. DIAM.	PITCH.	APPROX. WEIGHT OF MODEL	APPROX. SPAN.
1	30 c.c.	2500	24"	12"	10 LBS	12'-0"
2	18 c.c.	3000	16"	12'	7½ LBS	8'-0" to 9'-0"
3	15 c.c.	3500	16"	10"	7 LBS	8'-0" to 9'-0"
4	9 c.c.	3500	15"	8"	6½ LBS	8'-0"
5	6 c.c.	4000	12"	7½"	3½ to 4 LBS	5'-6" to 6'-0"
6	3 c.c.	4000	10"	6½"	2 to 2½ LBS	5'-0" to 4'-6"
7	1½ c.c.	4000	6" to 8"	5"	1 to 1½ LBS	2-11" to 3'-9"

Wooden propellers for petrol engines are so cheap to buy that many people adopt the attitude that it is seldom worth the while to make one. The best policy in this case is to try out several propellers and find the one that suits your model best. Then buy a number of spares of this type.

Metal Propellers

For some years I used cast Elektron metal propellers. Elektron is very light and easily bent cold if damaged.

It is also easily filed up. In the early days before commercial propellers were developed, I carved my master propellers for different sizes of engines and, when I had obtained the most efficient all-round propeller, I had castings made of these in Elektron by the Birmingham Aluminium Casting Co. Ltd., Birmid Works, Smethwick, Birmingham, for a few shillings each. I cleaned up these castings with a file and buff and balanced them. But unfortunately a metal propeller may be dangerous to careless wandering pedestrians, and I seldom use one now, in spite of the fact that it will outlive several wooden propellers. The metal propeller has an excellent flywheel effect and makes starting easier.

Carving and Balancing the Propeller

Some of my readers may wish to carve their own propellers. I am therefore giving below a sketch of how to set about the task, which requires practice, although it soon becomes a quite simple matter, even if a trifle laborious. See Fig. 94. It is very important to balance a propeller carefully for a petrol model, owing to the high speed of the internal combustion engine. Also the blades must be made of a correct airfoil shape.

A heavy and tough wood should be used for a petrol engine propeller in order to obtain a good flywheel effect. Straight-grained mahogany is excellent.

Plastic Propellers

The Americans are now producing plastic-moulded propellers for sale to the public. I have recently been using a plastic propeller made by the well-known "Frog" concern for their 1.75 c.c. petrol engine. Both engine and propeller have been excellent. Mass production and ease of manufacture should make for cheapness, and once a mould for a given diameter and

FIG. 94.

CARVING A PROPELLER.

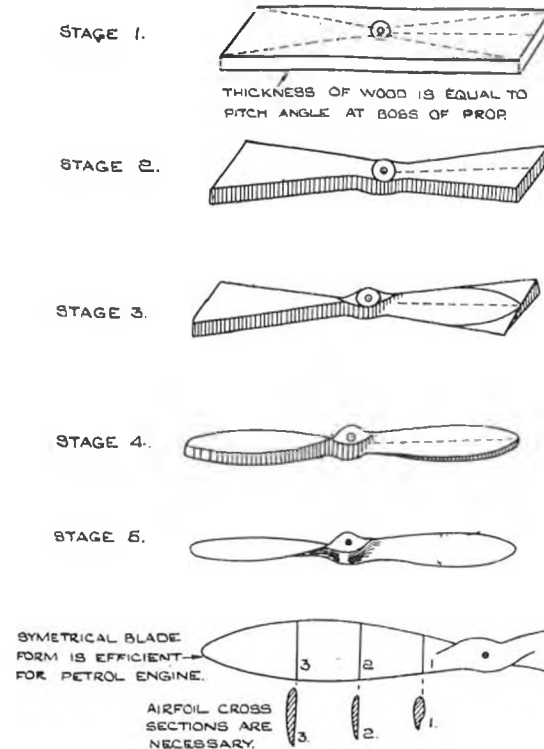

pitch of propeller has been set up, uniformity and accuracy will be obtained.

Here is a tip for the man who does not like calculating pitch, angles, etc. The Americans seldom talk about the pitch of their propellers in the commercial plans of "gas" models: all that is given is the drawing of the shape and the thickness of the wooden block. If the propeller is

carved from this block after the constructor has sawn around the shape and drilled a hole accurately in the centre, the pitch is automatically there! (Provided, of course, that the correct width of the blade is retained.)

In practice, therefore, it is quite possible to buy a propeller and find that it suits the model aeroplane. If so, you can measure its depth and blade width, and from this make innumerable replacements without ever knowing what pitch is being used! It is also obviously possible to carve similar propellers from slightly thicker or thinner blocks, try them on the model, and watch results. Remember to keep the same blade width, for if a wider or narrower blade is used it obviously alters the pitch angle. This is an effective, but a lazy method!

It must be remembered that the wooden blank must be tapered in depth towards the ends, to ensure that the propeller tips have a lesser angle of incidence than the centre. This is because the tips have a longer path to cover in revolving due to the radius being greater than nearer the hub.

CHAPTER X

"A SMALL COMPETITION MODEL."

"BABY BLUE DRAGON" FITTED WITH WING-TIP SLOTS

THIS small model has a well-known forbear. It has been developed from my old "Blue Dragon," an 8-ft. span model which held the British Record Petrol Duration from 1933 to 1937, and mentioned in Chapter I.

The old model has flown an enormous amount, and in one year won the "Sir John Shelley Cup" competition. Its secret was simple design, a lightish wing loading, with the ability to take hard knocks without derangement of flying trim.

Any small 3-c.c. engine, such as the "Ohlsson 23" or the 4-cc. Atwood "Phantom," is suitable to power the



Fig. 95. The "Baby Blue Dragon" is here seen on the famous race-course at Gibraltar, with the "Queen of Spain's Chair" (a hill) in the background.

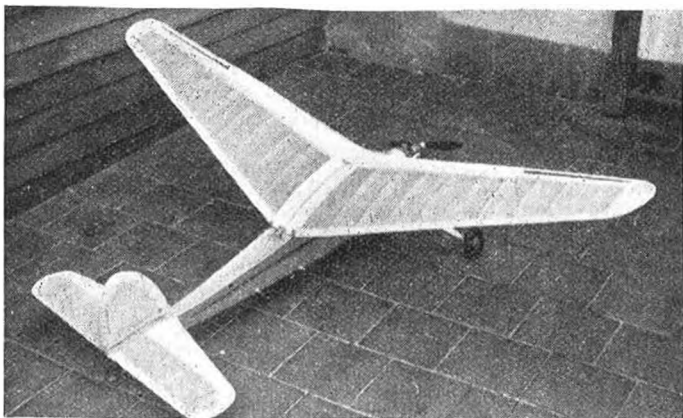
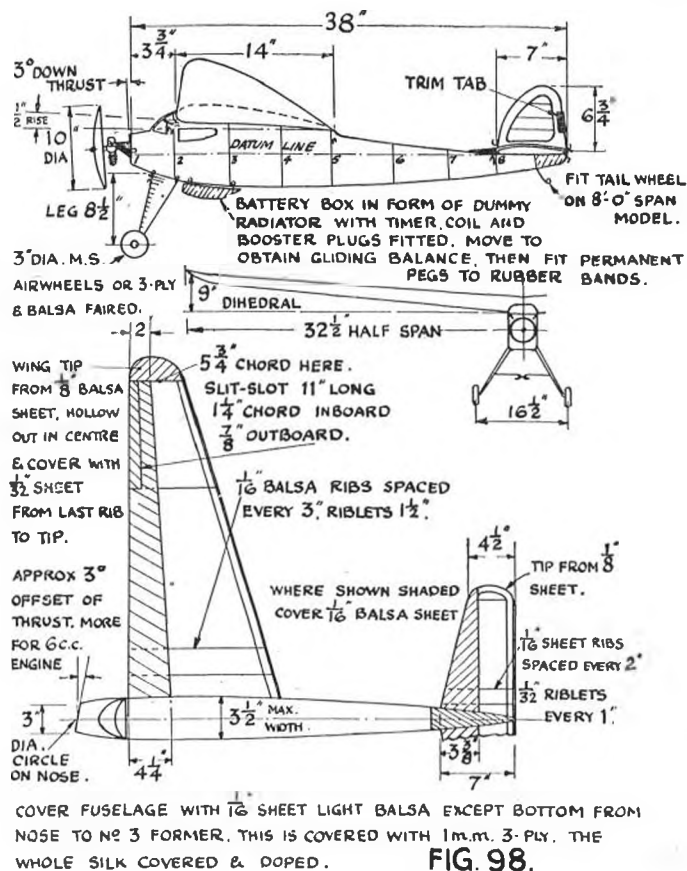
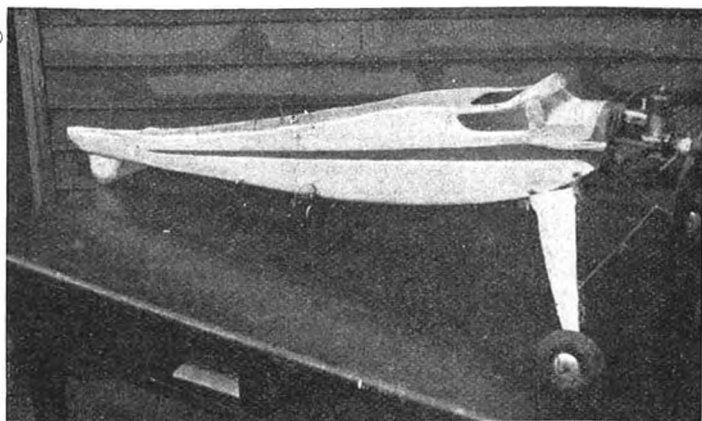

Fig. 96. The wing-tip slots can be seen clearly in this photograph.

"Baby Blue Dragon." In actual fact, I also fly it with an old 6-c.c. "Baby Cyclone" engine, which gives an interceptor-like performance on three-quarter throttle.

Fig. 97. The fuselage, showing shaped wing platform and access hatch (below wing) to the coil, which is strapped to the fuselage floor. The engine was inverted later.



This model is small and portable, and yet stable, and a particularly good glider, and "floats" easily in the air. As a result, it requires little extra power to make it climb. A low-pitched airscrew should be used on a slow-flying model like this.

I originally constructed this model to try out my wing-tip slots, and I found that the model is so stable with these slots that, even when flown up into the sky like a rocket

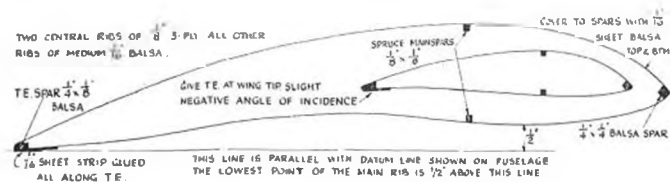

DIAGRAM SHOWING PROPORTION OF LARGEST & SMALLEST MAIN-PLANE RIBS FIG.98.A.

by the 6-c.c. "Baby Cyclone" engine, the model will pull out at the end of a most hair-raising climb without the suspicion of a stall. The model can be flown with a larger angle of incidence than normal, and also slightly over-elevated, due to the slots. It is most intriguing to watch the glide and the subsequent 3-point landing, with the nose well up. Under this set-up the model sinks rapidly like a flapped aircraft; the centre section of the wing is doubtless "Stallish," but full control is maintained at the wing tips. There is not the slightest desire to drop a wing.

The Figs. 98 and 98A, B, C, D, should make all details of construction and rigging set-up clear, if the methods of construction as laid out in Chapter VII are also consulted. If a 6-c.c. engine is used, greater offset to the engine-thrust line, and also increased down-thrust, must be given, and the battery slung further aft.

Should the reader desire to do so, this model could very well be scaled up to approximately 8-ft. span and flown

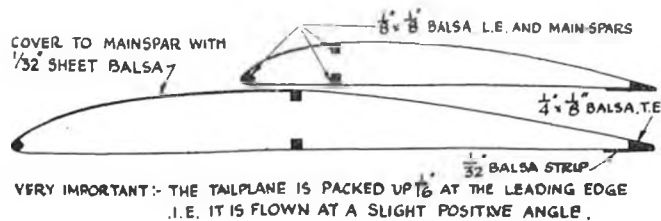

DIAGRAM SHOWING PROPORTION OF LARGEST & SMALLEST TAILPLANE RIBS. FIG.98.B.

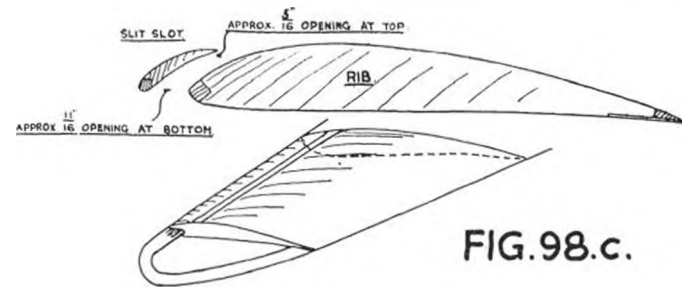

FIG.98.C.

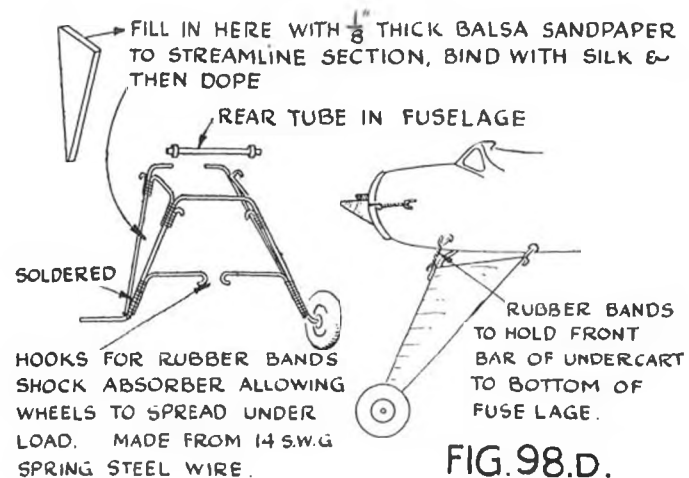

FIG.98.D.

by a 9-c.c. to 15-c.c. engine. Less dihedral angle in proportion would suffice. The original "Blue Dragon" was 8 ft. span—an 8-ft. span machine makes a very fine flying model.

The fuselage is constructed on my No. 2 method—see page 102—wings, tail and fin as described in Chapter VII.

CHAPTER XI

A BABY HIGH-WING MONOCOQUE MODEL.

THIS little model has proved itself an exceptionally pretty flyer, with quite one of the flattest glides I have seen, in spite of the fact that the model is a small one (small models are not as a rule good gliders). The "Swallow" is so clean aerodynamically that it can be flown by very small power. If a very small engine, such as the little "Elf" 2.4-c.c., is used, the model will fly very slowly around its owner. If a 3-c.c. engine (such as the "Ohlsson 23") of greater power is fitted, the model climbs like an interceptor fighter and yet has an exceptionally flat

Fig. 99. The "Swallow", seen on the race-course below the "Rock" of Gibraltar. It is here fitted with a 4 c.c. Atwood "Phantom" engine.

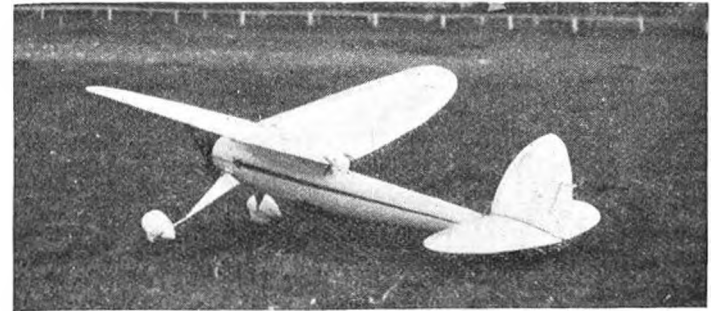
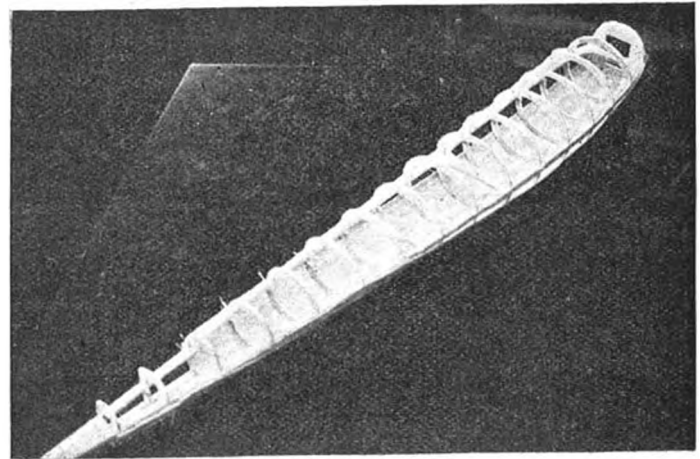

Fig. 100. This three-quarter rear view shows the efficient elliptical wing and tail plane, also the trimming tab in the fin, which is constructed as shown in Chapter VII.

glide at the end of its flight. I have also flown the model very slowly at low altitude with only a $1\frac{1}{2}$ -c.c. "Mighty Atom" engine installed. Also a 2-c.c. "Majesco" diesel.

The wing, tail and fin are of elliptical shape and built as described in the chapter on constructional methods.

Fig. 101. The fuselage is half planked and turned over. Half-oval formers are now glued on to the other side ready for planking.



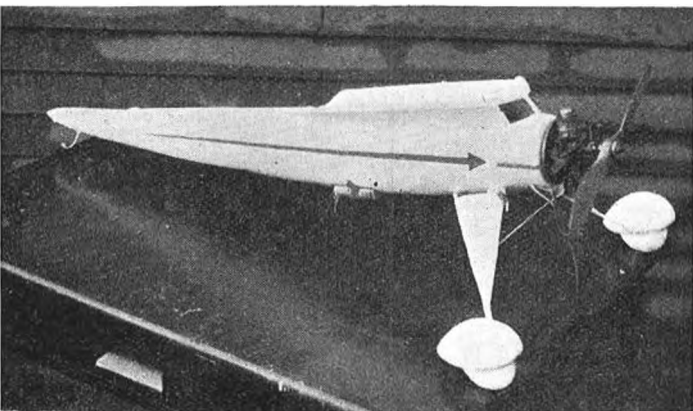

Fig. 102. The fuselage with its wing and tail platforms can be seen; also the undercarriage and detachable Electron engine mount as described in Chapters III and VII.

It is important that the wing platform angle and the tail platform shall be at the angles given on the drawings Figs. 99-104.

The fuselage is built on a balsa backbone as described

Fig. 103. The tail and half wing of the "Swallow" before covering.

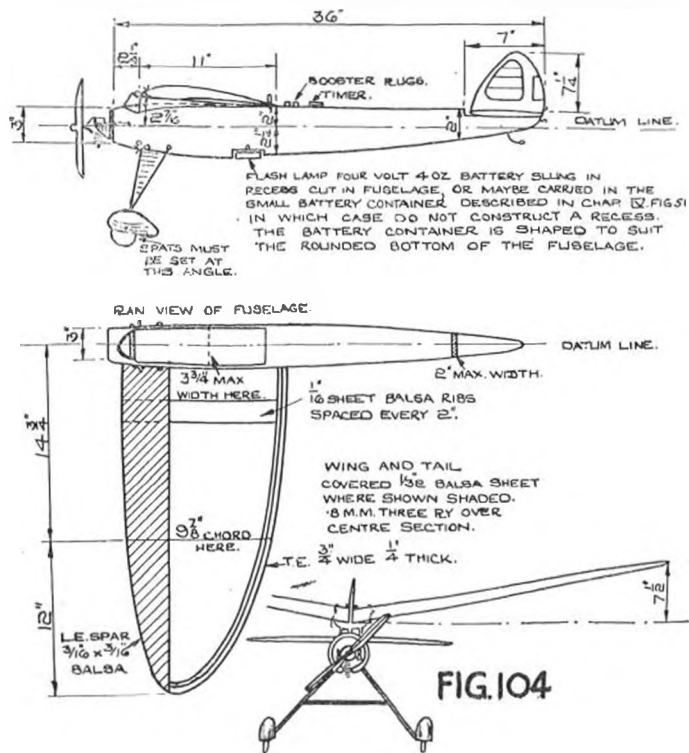
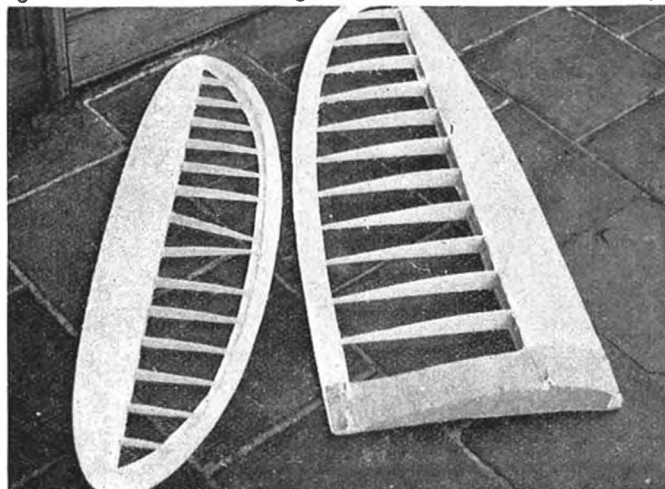
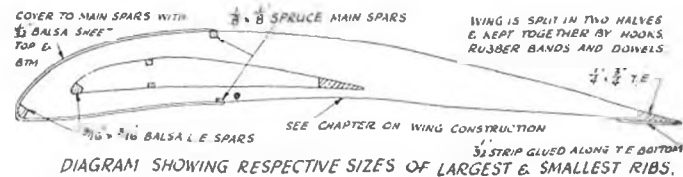
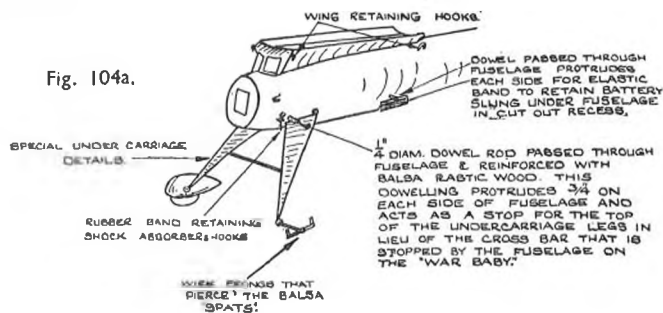

FIG.104





in the chapter on construction. It is planked with $\frac{1}{4}$ -in. \times $\frac{1}{16}$ -in. balsa strips. The balsa formers are spaced approximately every $1\frac{3}{4}$ in. The first former is a 3-in. circle of $\frac{1}{8}$ -in. three-ply.

A wing platform is built on top of the streamline fuselage. The front end is $\frac{7}{8}$ in. higher than the rear. The platform is $3\frac{1}{2}$ in. wide and is formed in a V to the correct dihedral angle, as shown in the general drawing.

The plan view of the fuselage tapers from 3 in. diameter at nose out to $3\frac{3}{8}$ in. across at the trailing-edge position of the wing, and then down to 2 in. at the leading edge of the tail. It is therefore quite easy, in conjunction with the side elevation measurements on the general drawing, to make a full-sized drawing and from this to space in the formers $1\frac{3}{4}$ in. apart.

Formers are drawn and made as in Chapter VII.

The coil is strapped down to the floor inside the fuselage by thread sewn right through the planking and a little balsa plastic wood is added to strengthen.

Three-ply balsa-faired wheels are used, as they are lighter and less bulky and fit inside the "spats" more easily on such a small model. The "spats" add much to the appearance of the machine. Fig. 61, Chapter VII, explains how to construct these "spats." The "spats" also serve a useful purpose of stability. They form side area below the C.G.

CHAPTER XII

A LOW-WING EIGHT-FOOT SPAN AND SEMI-MONOCOQUE MODEL

THE first reaction of the average newcomer to aeromodelling is to build a scale petrol model. In Chapter II it was explained why this is an inadvisable policy for the beginner.

In the present chapter I am describing and giving plans for a semi-scale type of model with streamlined monocoque fuselage. The lines are pleasant and the model looks well on the ground and in the air, but, wherever looks interfere with practicability, in my design looks have lost the battle. See Figs. 105-106, 107 and 108.

The model is designed for flyability and simplicity of construction and operation. It is the next best thing to a scale model and might form an intermediate stepping-stone between the beginner's simple model and the full-scale type of model like Dr. Forster's "Spitfire," a photograph of which is given in Chapter XV.

The fuselage is built on the lines described in Chapter VII for monocoque models and is balsa planked. The wing, tailplane fin and undercarriage construction is also described in Chapter VII. In this connection, the reader will find that Figs. 67, 74, 75 and 76 are actual photographs of this model's wing.

I would recommend that a 9-c.c. engine is fitted, and on this model I arranged that the flight battery should be carried below the wing centre section in the dummy radiator containing battery and clock (as described in Chapter IV). The photograph of the radiator seen in Fig. 26, Chapter IV, was taken from this model. The



Fig. 105. The author's low wing semi-scale monocoque model "Mallard." The fuselage is balsa planked.



Fig. 106. The low-wing platform and its fairing can be seen in this photograph.

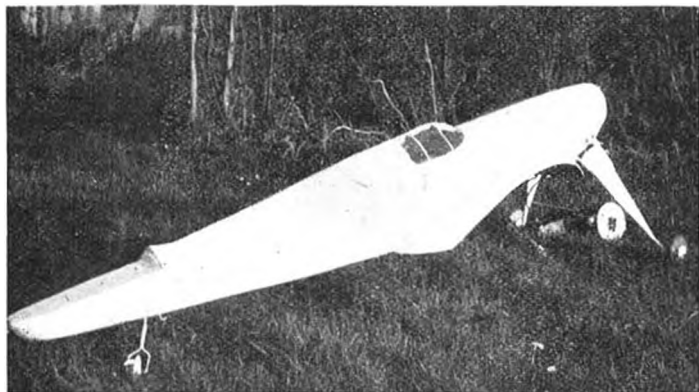

Fig. 107. The swivelling tail-wheel and tail-plane platform are clearly shown. (Refer back to Chapter VII.)

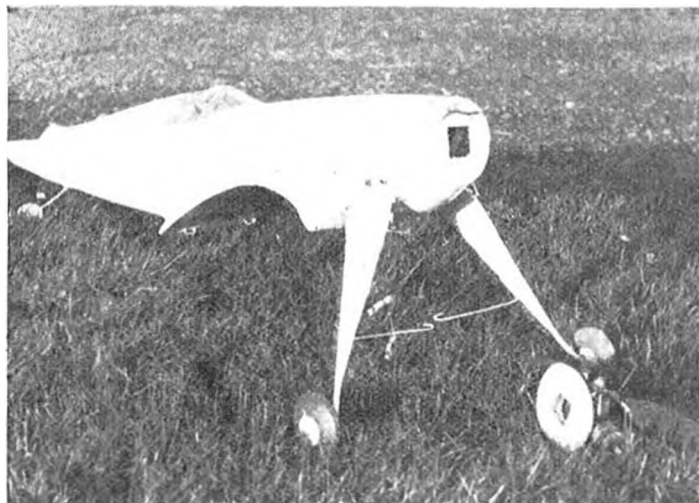
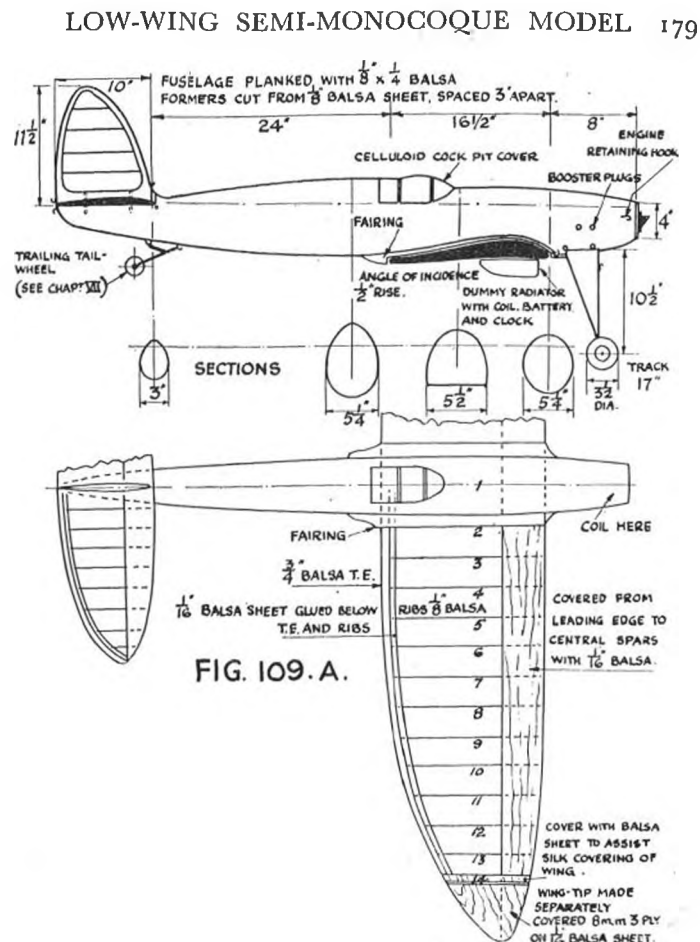
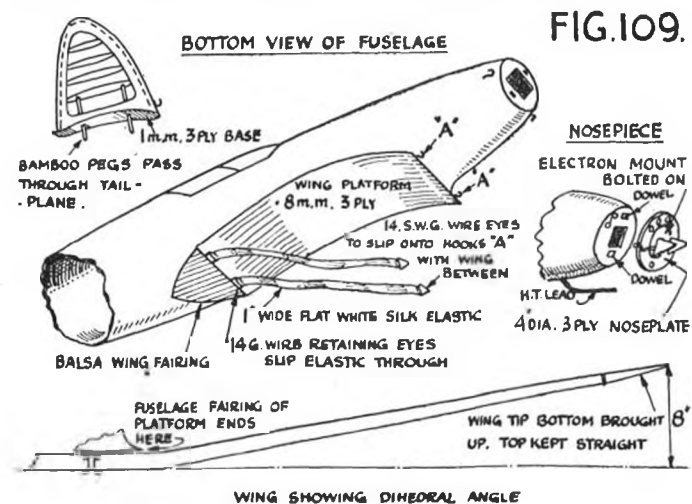

Fig. 108. The detachable engine-mount . . . the two booster battery socket holes . . . the detachable undercarriage . . . and wing platform and its fairing of balsa and plastic wood are all clearly seen in this photograph.

coil can also be in the radiator or, if the builder prefers, it can be strapped to the floor of the fuselage just behind No. 1 former.

A small final weight of lead may be required to be built into the fuselage during gliding tests. If the model noses up on the glide, add lead to the nose. If the nose drops too steeply, add lead to the tail. It is vital on a streamlined model like this to get the glide perfect before power flight is attempted.

As the nose former is 4 in. diameter to allow of a simple sheet cowling for the engine (if desired), I made a thick three-ply detachable engine nose backplate 4 in. diameter. To this I attached one of my Elektron castings. If the reader cannot obtain one of these castings, simple sheet-metal engine bearer arms can be bolted to the three-ply detachable nose backplate. Elektron castings can be obtained from "B.M. Models," Westover Road, Bournemouth. I found that, as the model is large and comparatively heavy, the undercarriage tubes had to be very stoutly fixed in the monocoque fuselage.



Whilst building the fuselage, I placed solid balsa blocks above the tubes. These were cemented to the fuselage sides and strengthened with plastic wood. The tubes were bound to three-ply formers instead of the usual $\frac{1}{8}$ -in. balsa formers which have otherwise been used throughout the model. The wing is nearly 8 ft span and is split in the centre and held together by stout 12 s.w.g. wire hooks

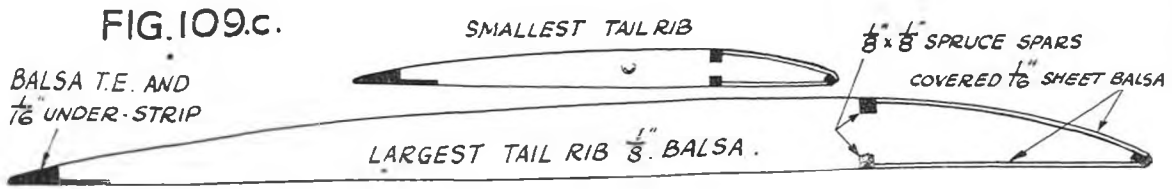
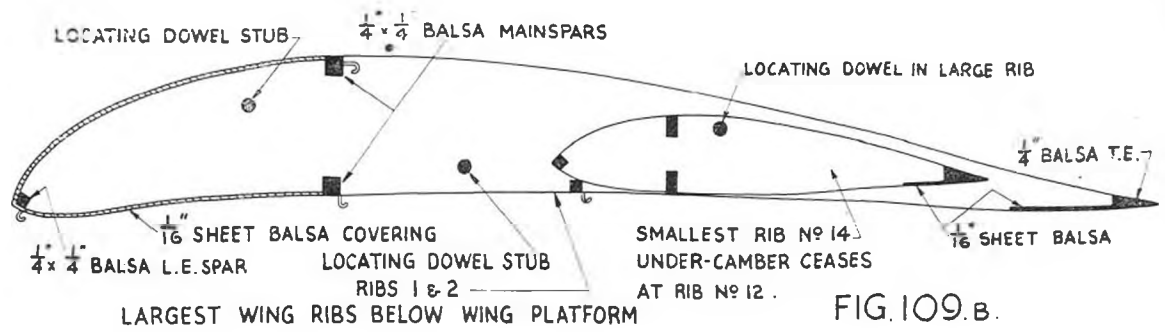

with rubber bands. One is placed at the leading edge and one at the trailing edge (both looking downwards, as it is a low-wing model). Two are placed at the bottom (one is located at the bottom lower mainspar and the other a few inches to the rear at a small extra spar placed between the central ribs for this purpose). As the top of the wing has to fit up snugly against the wing platform, the top hooks are placed at the sides of top spars, and a small hole is cut from the 1-mm. three-ply covering of the centre section to allow access to these hooks. (See photographs in Chapter VII, Figs. 75 and 76.)

In order to keep the machine as aerodynamically clean as possible, the wing is kept to the fuselage wing platform by a rather novel arrangement of broad white silk flat elastic. As a result, the wing can be fixed in position in a few seconds, and it is as quickly detachable. It is also easily knocked off in the event of a crash or a bad landing. The details of this can be seen on the drawings, Figs. 109 and 109A, B, C.

The main drawing and also Fig. 108 show details of the wing fixing. *It is essential to securely anchor the wire fittings into the fuselage when building*, by binding with thread, and using plenty of plastic wood. Sufficient offset has to be packed between the nose former and engine mount to suit the torque created by the power output of the particular engine fitted. The model should be flown with as few engine r.p.m. as possible, which is one of the secrets of low-wing model performance. Overpowering a low-wing tends to turn the model over by excessive torque.

CHAPTER XIII

FLYING BOATS AND FLOAT PLANES

THE petrol-driven flying boat is, perhaps, one of the most interesting types of model and produces more problems for the designer than any other, for it has two elements to overcome. Watching a petrol flying boat take off the water is a beautiful and soul-satisfying sight ; the hull unsticks, leaving the white wake created on the surface of the water, and glistening drops of water fall away from the steps. There is also all the fun and pleasure of a day on the water in a boat.

It so happened that I was the first individual in this country to experiment with a petrol-driven model flying boat, and I set up the first record for this type of model (rise off water) . . . at Poole in 1936. This record has remained unbeaten up to the time of writing in 1946, although there have been a number of much longer unofficial flights since then both by myself and other enthusiasts.

In the future, I feel there will be considerable interest taken in the flying boat, owing to the sport that can be obtained from it. Up to now there have been very few successful model power-driven flying boats other than rubber-driven.

A few years after my early flying experiences, Dr. Forster, who lives in the same home village as I do, entered the field and produced some excellent boats. He stayed with me at Gibraltar for a holiday and we did some flying over the harbour together. We have also flown boats together off the Bristol Channel at Porlock Weir. Fig. 110 is a photograph I took of the flying boat he flew at Gibraltar.



Fig. 110. Dr. Forster's boat flying at Gibraltar.

When I decided I would attempt an officially observed record for a petrol-driven flying boat, there were no data to draw from, because, as far as was known, no one had got a model petrol boat off the water. I therefore designed what now looks a most peculiar affair with certain features that I considered would ensure a take-off without a pilot's hand to ease the boat off the water, and a boat that would not slew round out of wind. It had to possess certain stability features to ensure that the boat would sit on the water before and after the flight without a wing being blown into the water by the wind or the tail being

submerged by wind blowing on to it from above. The result is shown in Fig. 111, which shows the 8 ft span boat in the air. This model set up the British record referred to, but after the one flight the engine could not

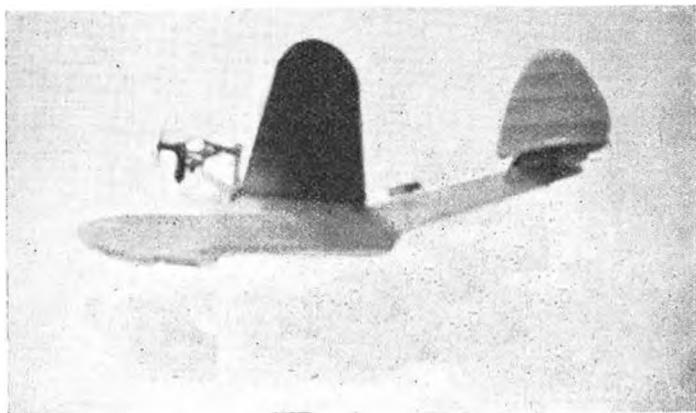

Fig. 111. The record-holder snapped in the air. Note the forward step in front of the main step.

be induced to start up again on that day owing to ignition trouble due to sea-water spray. The official observers then dispersed and I had to leave matters at that, because I was then posted to Gibraltar for a tour of duty lasting until the war.

I built several boats at Gibraltar and gained much valuable experience there with flights in the harbour or the comparatively sheltered water outside. Fig. 112 is a photograph of a simple, but highly successful, little boat of 4 ft. 6 in. span powered by a 6-c.c. "Baby Cyclone" engine.

Fig. 113 shows this flying boat flying round the well-known harbour of Gibraltar with the famous old "Rock" in the background.

Design Features

My experiments brought me to the following conclusions up to the date of writing this book :

1. *Take-off*

The engine thrust line of a flying boat must necessarily be high in order to keep the propeller clear of the hull and the engine clear of spray. The resistance of the water on the hull's bottom creates a powerful "nose in" reaction, i.e. the engine tries to go forward and the hull pulls back, therefore the engines tries to pull downwards around the resistance of the hull.

As we have no pilot to lift the boat's nose during the early stages of the take-off, we must either place the main step of the hull well forward of the C.G. or we can place,

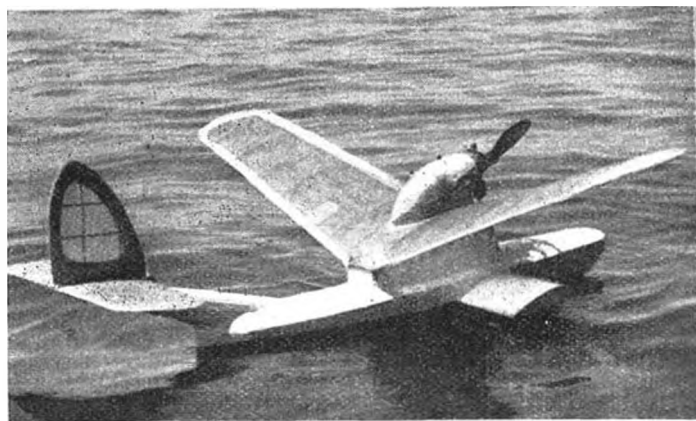

Fig. 112. The author's little flying boat, powered by a 6-c.c. "Baby Cyclone" engine. A large dihedral angle and high tail unit make for lateral stability in the air, while the long water line and large sponsons take care of the equally important stability considerations on the water.

an extra step forward of the main step, keeping the main step on—or about—the C.G., which helps the take-off. In my first record-making boat, I introduced the forward

step idea and set this at a slightly less height than the main step. It worked wonders, and I have found that it gives a greater number of consistent "takes-off" than the usual method of placing the main step forward of the C.G. In practice, the boat's nose begins to dig in, the forward step kicks up the nose and the boat gets on to its main step with sufficient flying speed to take-off. The angles of these two steps and their correct positioning are very important.

If wing-tip floats are fitted, there is a danger that one float will dip, owing to engine torque during the take-off, as the float is well outboard and has a powerful slewing effect, and the model will get out of the wind and the take-off be ruined. It is therefore usually desirable on a petrol model to fit sponsons instead of wing-tip floats. Most flying-boat models are fitted with a single engine, owing to the difficulty of getting two engines to produce the same thrust. The other alternatives would be to fit contra-rotating propellers, or jet propulsion.

Good fin area is necessary to give directional stability during the slow speed part of the take-off. I often now use a dihedral tailplane and twin fins set slightly outwards to act as a drogue to keep the boat's nose into the wind.

2. Landing

It is obvious that a model flying boat must glide in on an even keel, or one sponson will touch first and cartwheel the boat around, so drenching a wing. Therefore good lateral stability is essential. A good dihedral angle helps this, with a short wing span. The fin must be set straight, as once the engine stops, the model *must* glide in straight. Any turn on the glide will cause one wing to fly low and the model will touch one sponson first, with the result mentioned above. It is also essential that the model shall glide flat, so that the nose does not dig in. The forward part of the boat's hull should be

well V-shaped to part the water and reduce the shock of landing. A quicker take-off is obtained if the main step is only slightly V-shape.

3. Stability on the Surface

To my mind, a boat has to be just as floatworthy as airworthy. This means that lateral and longitudinal stability on the water is just as important as in the air. A short span helps this, as there is not the overhang of long wings. Wide sponsons of a fairly thick buoyant section complete the picture.



Fig. 113. The flying boat circling the harbour at Gibraltar after having taken off unaided.

A model is generally fitted with a large tailplane for stability in the air. On the water, the wind tends to blow on top of this and push it into the water, and so ruins the rest of the day's flying. It is therefore essential to give plenty of area aft on the hull bottom in order to counteract this tendency.

4. Ignition Troubles

Sea water, and indeed ordinary water, too, quickly stops the vital ignition spark (*vide* my first record flight,

already described). Sea water corrodes wiring and electrical connections very rapidly. It is therefore a great mistake to mount the coil and battery (or accumulator) in the hull. If the design permits, it is a far better plan to keep all electrical gear as high as possible out of the spray and mounted in a detachable power egg that can be cleaned and dried out easily after flying operations. We have a great deal to learn in connection with this fascinating branch of modelling, and it behoves one not to be too dogmatic at this stage of the flying boat's development.

My Latest Design for Post-war Flying

I have put all the experience so far gained into a model that I have built called "Blue Goose." Fig. 114 gives a general view of the model, in which can be seen that my usual type of wing-tip slots are fitted.

The bottom of the hull has three steps and a long waterline to ensure longitudinal stability on the water. The sponsons are also stepped to assist take-off.

The power egg is detachable with a g.c.c. "Brown Junior" engine fitted. The engine, coil, baby accumulator and all wiring are in the detachable egg, which is mounted high up out of the spray. It is mounted on a thick three-ply rib, which is sandwiched between the two wing halves when erected. I therefore now have a water-tight hull with *no electrical wiring* that can corrode or short. The power egg can be taken off and washed with fresh water and dried out in front of the fire at home should the boat get a ducking. I consider this a most important point.

Floatplanes

There have been very few power-driven floatplanes in this country. One of the earliest successful models was built by Mr. Desoutter, of full-sized aircraft renown. He flew the model off the sea at Eastbourne before the last war. This model was steam-driven and

had three floats, two forward and one aft at the tail.

The Americans have produced a number of petrol-driven floatplanes in recent years. Most of these have been converted landplanes, and usually covered with paper, which, although cheap, is not a suitable covering for use on water, as it is so easily damaged when wet. In my opinion a scaplane or flying boat that is not stable on the water is a waste of time and not worth building. We should, therefore, as model builders, study the peculiar

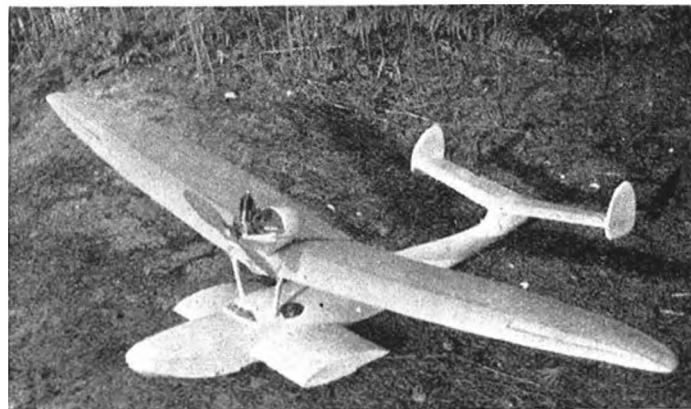

Fig. 114. "Blue Goose," one of the author's latest flying boats, has a monocoque hull, with engine, coil, accumulator and wiring in the detachable power egg.

problems connected with the design of the difficult but attractive floatplane.

There is so much surface high up on a floatplane that the model is easily blown over or the tail under. We must, therefore, have ample surface on our floats and these floats must be spread so that there is a firm base of support on the water. This spread must obviously be a compromise, because if the floats are spread too far apart structural weight rises, too much drag of long struts is introduced, and a float too far outboard will

swing the model out of wind on the take-off. Unless we grossly over-power our model, the floats must be capable of easy planing and run clean on the water. During my fairly extensive experiments in the model hydroplane (speedboat) world I found that a lightly-loaded and rather large hull bottom surface, set at fine angles, planes over water at slow and medium speeds, more easily than a small, heavily-loaded surface.

It is slow-speed planing that we require for the initial movement of the take-off. It is therefore desirable to have floats with larger planing surfaces in proportion to those of full-sized seaplanes. The "clever critic" immediately jumps up and talks about increased wetted surface and skin friction. Like all design, it is a matter of the most suitable compromise, and I have always found that the most vehement on such matters are the theory experts who have never tried out their theories in repeated practice!

If the reader will look at Fig. 115, he will see one of my early petrol-driven floatplanes fitted with outsize floats of great buoyancy and large planing surfaces set at low angles of attack. It was impossible to blow this model over in all reasonably light winds suitable for model seaplane flying. It took off water with a slight popple on it, quite easily, with a 9-c.c. "Brown" engine fitted. The wing span was 7 ft.

Later, I built a successful model of smaller dimensions and more highly-loaded floats, proving that smaller floats could be used; but the model was not so stable on the water in anything but very calm weather. Incidentally, in flat calm, with an "oily" surface on the water, it is a well-known fact that full-sized floatplanes and flying boats have difficulty in getting off the water. A slight popple is required to create the steps, and in full-sized practice it has been found necessary sometimes to run a speed boat backwards and forwards on the runway to create artificial breaking-up of the "oily" surface.

It must be granted that such excessively large floats are very ugly, but I always design my first experimental models of any type with complete disregard for looks! After the necessary data has been obtained, conclusions can be drawn and refinements in design arrived at on the next model. I like to play for results and safety at the first attempt. This is so much more encouraging!

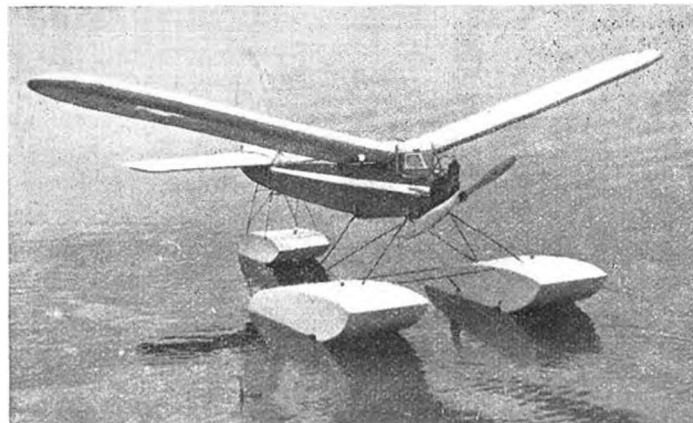

Fig. 115. The author's early experimental float plane. The large area of the float will be noticed.

I feel that the average acro-modeller will wish to produce models with smaller floats than on my original experimental model, but it should be remembered that they should be kept larger in proportion than on full-sized aircraft. I have since built a model with narrower floats, although it has considerably larger and wider floats than in full-size practice. The point that satisfies me is that it takes off the water and flies, and is so stable in reasonable weather on the water.

Two-Float or Three-Float Arrangement

I have built a number of twin-float rubber-driven seaplanes which have operated successfully: some in

competitions. But I am forced to the conclusion that, if maximum seaworthiness is required, the more usual model arrangement of three floats wins. Nevertheless, the twin floatplane looks much more like the real thing and can be a practical proposition.

If the normal single step is to be used, this should be situated well in front of the C.G. position of the model, although I seriously advocate the three-stepped arrangement that I have described on my flying boats. Up to date, I have also always used the extra forward step on my floatplanes, and they certainly take off the water.

Floatplane Design Features

I have found it a great advantage to keep the fuselage a separate water-tight unit as on my flying boat "Blue Goose." The engine, with its coil, accumulator and all wiring, can be produced in one detachable unit.

The advantages of having a detachable engine unit that can be dried out are equally as great here as in the flying boat.

I have always built my floats and their struts in one detachable unit, which is held up to grooves on the bottom of the seaplane fuselage by rubber bands. Thus, if the model does get into trouble and is foolish enough to hit something with its floats, the whole float gear can be knocked back and so is normally saved much damage. Even over waters in lakes or harbours, models may fly into a moored boat or trees on the lakeside!

I am compiling a book on the detailed design and construction of the petrol model flying boat and seaplane (floatplane), as I consider that the subject is a specialist one, and to be dealt with at length in this book may confuse the issues of simplicity for the novice.

I have recently flown the "Blue Goose" flying boat successfully with a diesel engine that eliminates ignition gear drenching.

CHAPTER XIV

AN AMERICAN LINE FLYING MODEL, WITH REMOTE CONTROL

Remote Control

IT is becoming increasingly popular to fly a model round the operator, with the model tethered to a line and with one or more lines to control its elevator and in some cases its engine. In America this is all the rage.

There is the fun of personal control of the model, whilst considerable speeds can be indulged in without damaging the model. Very small-scale models, flying around like powered brickbats, can be produced with a nice streamlined shape.

Centrifugal force naturally plays a large part, but there is a definite skill attached to the sport, and racing can be indulged in, as each competitor's time per lap can be taken by stop-watch and, if a stipulated length of line is used, the miles per hour can be worked out, as in the case of round-the-pole model hydroplane racing.

There are several methods of controlling the elevators of the model, and the sport is called by several different names, such as line flying, remote control and "U" control. As the Americans introduced the cult on a serious scale, I am reproducing drawings of an American model, and extracts from the writings of a well-known American exponent.

Fig. 116 may interest readers, as it shows an early experiment on these lines carried out by Dr. Forster and myself, using one of his general-purpose models attached to a fishing line and rod. Unless the elevator can be controlled, the snag is, of course, that, except in dead calm weather, the model climbs during the upwind part

of the circle and dives down on the down-wind part. Remote or "U" control largely gets over this difficulty, but in calm weather it is possible to fly a model round oneself, playing it with a rod and line.

Fig. 117 shows two American methods. The left-hand sketch is the subject of extracts, published in this chapter, from an article by Mr. William B. Schwab, a well-known



Fig. 116. An early attempt at remote control flying. Dr. Forster has been caught by the author's camera plying his petrol model on the end of a fishing rod and line. The author later succeeded in damaging Dr. Forster's model when the wind rose.

modellist of America, and originally published in *Gas Models*.

I am indebted to Mr. Robert McLarren, managing editor of the American journal, *Model Airplane News*, who has kindly given permission for the publication of the following extracts and the accompanying constructional sketches.

Extracts from Mr. Schwab's American Article

"Just for the fun of it we took one of our old crates and connected a string to the wing tip, one-third from the leading edge. A tab was glued to the rudder and wing to make the ship tend to pull away from the operator, or turn sharp to the left, the ship flying in a clockwise direction.

"We connected it up, started the motor and let it run at half-throttle. Surprising as it was, the ship left the ground and flew in perfect circles at about 5 ft. altitude. When the motor cut we could keep the ship in the air long enough to bring it in and set it down next to the booster batteries and gas, by pulling on the string and kiting it in the air.

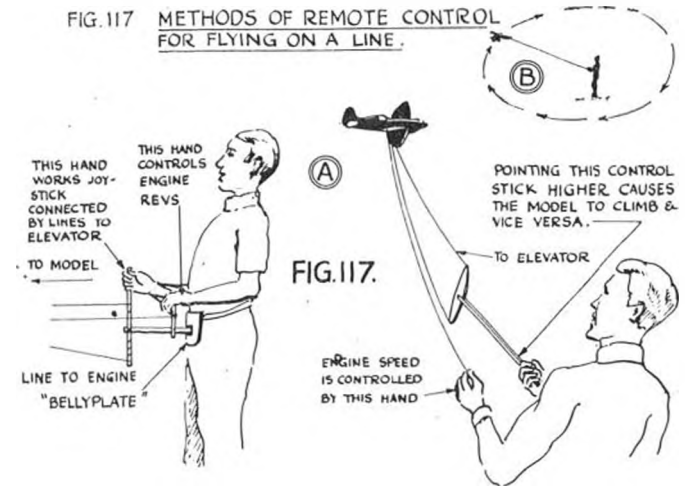

"We kept flying for many months in this manner, until one fine day the motor was opened up just a little too much. There followed a crash!

"We now fitted movable elevators—Wow, what a thrill we had in store for us—we succeeded in using two strings

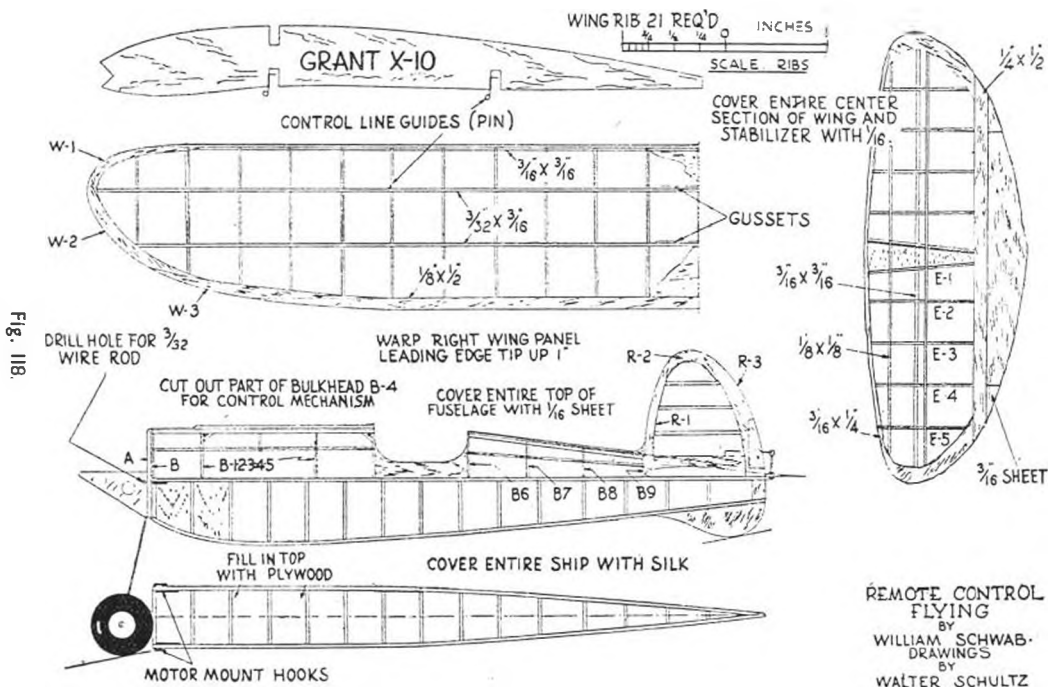

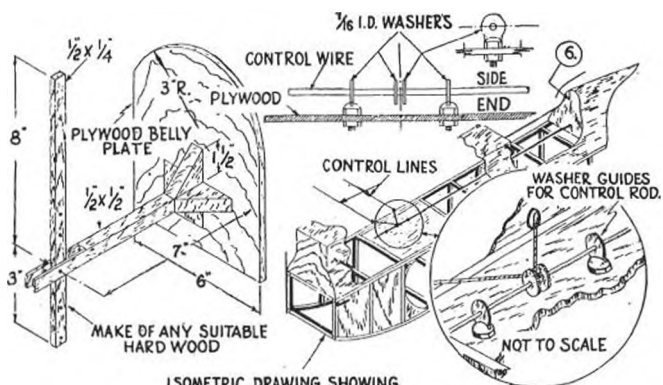

ISOMETRIC DRAWING SHOWING CONTROL MECHANISM

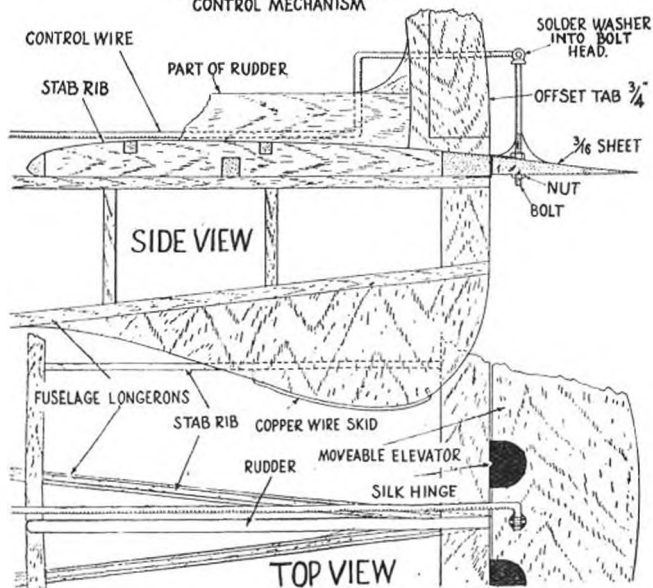

Fig. 119.

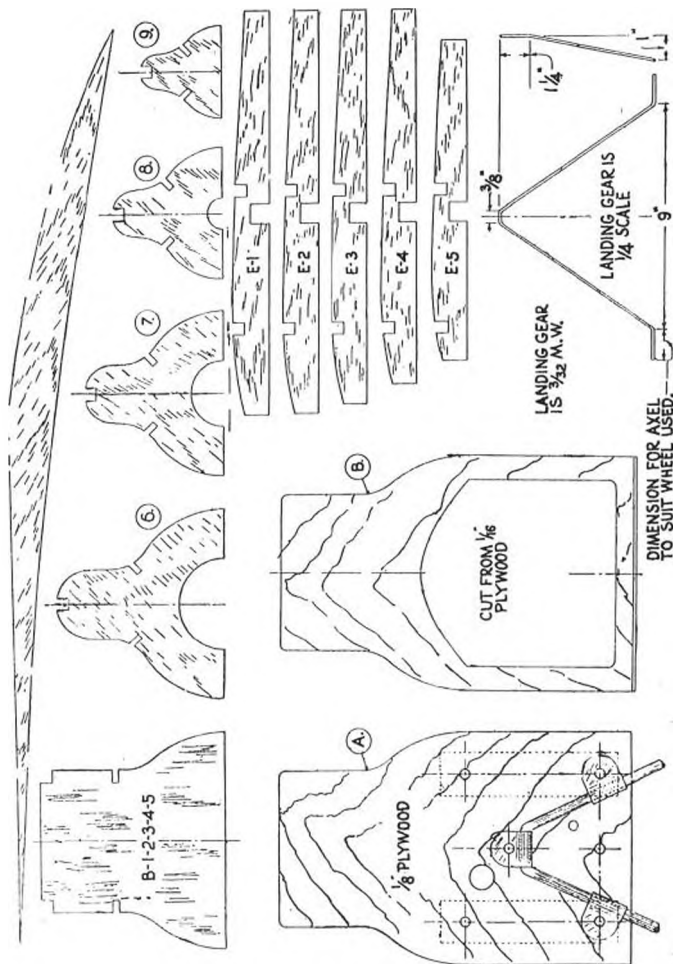

Fig. 120.

for up-and-down control of the flippers ; these same two strings also supported the ship while flying in circles. These strings were connected to a small joy stick about a foot in length. The stick was made so we could strap it under our belt, leaving us free to walk about, and our hands free for controlling.

“ With this system, the ship about 30 ft. away, flying around the operator in circles, could be controlled perfectly. We could set the ship on the ground with the motor running and using the stick, raise the tail in flying position, pull 'er back and take-off exactly like a real airplane : climbing and diving the ship within a few inches of the ground and pulling her out without stalling or crashing in. We can truthfully say that almost any ship that will fly free can be adapted to remote control.

“ Open almost full to keep perfect tension on the control lines. *Be very careful not to over-control.* Let the ship take-off unassisted. On the take-off, keep the stick forward until you have reached flying speed, then pull back slowly. The minute the ship leaves the ground, move the stick slightly forward to prevent stalling, then 'feel' the model out. Try and have the ship several feet off the ground when the motor stops. After you have acquainted yourself with your ship you won't have to worry about flying in windy weather. In windy weather, always take-off with the wind. By the time the ship takes off it will be flying across wind with the control lines taut. When the ship comes across wind again, take a few steps backwards to keep the wires taut.

“ Recently we perfected a method by which we could regulate the speed of the engine, making it possible to throttle down and land, open 'er up and again take off, etc. Here's how. Use an old 'Brown Junior' choke nut and slip it over the end of your intake tube. Solder a piece of 0.034 wire across the rear of the nut, to act as an arm to close and open the air. Solder a fine spring

to one end of the arm, to bring the choke nut back to the closed position. To the other end connect ordinary sewing thread for the control line; run this thread through the necessary pulleys made from straight pins, bringing it out from the fuselage between the two elevator control lines. An extra throttle control arm can be screwed to the joy-stick support. Speed contest can now easily be had with remote control. A definite diameter set up and times calibrated, with a certain number of laps stipulated. Flaps and retractable under-carts can be tried out on a remote control ship.

Hydro Remote Control. A low-wing buggy has been rigged up with pontoons; it flies beautifully. When flying this type of model, the operator stands on the shore line, the ship is started from the shore and sent straight out. The ship is given 180° of the 360° to get off before it comes around and flies overland. This is more than enough take-off area; for, with the flipper controls, you can almost stall the ship off the water into a 90° climb and level it out. The only thing to watch out for is the engine cutting out over land. We had this happen quite a few times, our big mistake was pulling back on the stick when trying to lengthen the glide. In every case, instead of a better glide, the tail section would drop and slow the ship down and, as a result, would drop faster. Don't get the control lines wet. Try to secure fine flexible wire for control lines, when flying over water, instead of fishing cord. In order to adapt controls for your own ship, just use in proportion the amount of area needed in your ship's controls compared with the ship described.

"Metal tabs can be attached to the left wing panel and the rudder, set to bank and turn the ship to the left. The movable elevator can be made the desired width and connected with silk hinges to the present stabiliser. Connect up the rest of your ship in the same manner as shown in the drawings. The drawings are for those who

want a real top-notch performer, one which has been well tested. If any of you want a ship that will really perform for contest or for remote control, this is it.

Tail Section. After scaling up the drawings, use a good hard piece of $\frac{1}{8}$ -in. square for the bottom stabiliser spar; the leading edge of medium $\frac{1}{8}$ -in. \times $\frac{1}{4}$ -in. stock and the trailing edge, hard $\frac{1}{4}$ -in. \times $\frac{1}{2}$ -in. balsa. Top spars for the stabiliser are of $\frac{1}{8}$ -in. square. The ribs, shown full size, are of $\frac{1}{8}$ -in. sheet. The movable elevator section of $\frac{1}{8}$ -in. balsa is hinged to the trailing edge-piece with six pieces of doubled silk about $\frac{1}{2}$ in. \times 1 in. Three pieces on each side of the horn. Glue the outer hinges on top of the elevator section and on bottom of the stabiliser.

"Next, the two inner hinges; glue the silk to the bottom of elevator section and to the top of the stabiliser section. The two inner hinges are the same as the two outer ones. Inlay the top and bottom between the centre ribs of the stabiliser with $\frac{1}{8}$ -in. sheet. The rudder outline is made of $\frac{1}{8}$ -in. sheet and ribs of $\frac{1}{8}$ -in. squares. Cut in the rudder tab and adjust to full left rudder and cement. The elevator horn length is optional; the longer the horn, the less sensitive the ship's action. On this particular ship the horn is 1 in. in length.

Fuselage. Longerons and braces are made from hard $\frac{1}{8}$ -in. square. Install the $\frac{1}{8}$ -in. sheet plywood between the top longerons where designated; this plywood platform supports the entire weight of the ship, so cement well in.

"Drill holes for the two bolts in the plywood 1 in. apart and $\frac{1}{4}$ in. away from the longeron. The two bolts are put in place with $\frac{1}{8}$ -in. inside diameter washers soldered to the head of each bolt. These washers will serve as guides for the single control wire which leads from the elevator horn. Two small washers are then soldered to the control wire, $\frac{1}{32}$ in. apart, halfway between the two guide washers. After the horn is bolted on the elevator

and the entire tail section covered and glued to the fuselage, hold the elevator in neutral position, bend and cut the control wire to fit the elevator horn. Make sure that the elevator is level and the small washers that are soldered to the control wire are halfway between the guide washers ; they ensure the same amount of up-and-down movement on the flippers. Opposite the two guide washers, two eyelets are cemented 1 in. apart, $\frac{1}{4}$ in. above the longeron, in the sheet wood covering.

“For control line, use two 30-ft. lengths of good-grade fishing cord, with about 15 lb. test pull. Take 2 ft. of this cord and determine the centre between the two small washers which are soldered to the control wire. Run each end through the eyelets out of the fuselage. When connecting up the control cords from the joy stick to the ship, run the cords for it through the wing cord guides, then tie them to the permanent cords from the fuselage, being sure that the bows (not knots) will not get caught in the guides when either of the cords is pulled.

“Unless you have an exceptionally smooth place from which to take off and land, equip the ship with exceptionally large wheels. We found that 3-in. wheels enable us to take off or land on grass lawns under full power without nosing over.

“*Ignition Unit.* On this particular ship a simple ignition stick is fastened to the firewall and coil and heavy-duty battery strapped thereon, the heavy battery doing away with boosters.

“*Wing.* Dihedral : lay one wing panel flat on the work bench and raise the opposite panel $\frac{1}{4}$ in. Inlay centre section of wing with $\frac{1}{8}$ -in. sheet on top and bottom. Install control-line guides through wing spars, sixth rib from the tip. These guides can be bent from a straight pin and glued into place.

“*Covering.* Cover with silk, due to the abuse the ship will get.

“*Joy Stick.* The belly plate is made of $\frac{1}{4}$ -in. plywood, 6 in. \times 8 in. The joy stick support is made of any suitable hardwood and is screwed to the belly plate and braced up with hardwood gussets. Slot out the front of the support stick to receive the joy stick. Cut the joy stick to shape and drill in five holes, one for the pivoting point and the others for control lines. You can use either the two outer control-line holes or the two that are closer together, depending on how much control action you want. When in use, the belly plate is strapped to the operator with his pant's belt. When not in use, the plate will serve as something to wrap the control lines on.

“*Test Flying.* Test the flying on a calm day and keep the control lines from dragging on the ground, especially when the ship is released for the take-off. Have someone to hold the model up in the flying position, holding the elevators perfectly level and the joy stick perfectly straight. Then connect up your control strings, being sure that the tension on both strings is the same. Set the model on the ground, so that the ship is at 90° angle to the lines.”

CHAPTER XV

EXPERIMENTAL MODELS

To the man who has obtained satisfactory flight with normal-type machines, experimental models form the most interesting and useful kind of model-making adventure.

Radio control for models is still in the experimental stage, and there is a great deal to be done in this direction before it can be considered efficient and cheap to build and operate. During the war period, however, much light-weight equipment was produced which can be adapted. Chapter XVI gives the reader a practical solution by a man who has been engaged on the subject for war experimental purposes. Jet propulsion opens an interesting field for experiment. The helicopter, the autogiro and the flying wing, with no tailplane and buried engine, all offer scope for experiment and deserve attention by the serious aero-modeller. Very little seems to have been accomplished as yet, in these experimental lines. Aero-modelling has progressed on rather stereotyped lines, and a breakaway by the more experienced aero-modeller should be encouraged.

The Autogiro

Some years ago, I built two petrol-driven model autogiros. I proved to myself that the autogiro with single rotor is a practical proposition, but inclined to suffer damage to its revolving rotor blades during bad landings.

I came to the conclusion that two rotors revolving in opposite directions and mounted on outriggers in the

form of a small dihedralled wing would be more stable. Unfortunately, I have not yet had time to complete these experiments. Fig. 122 may start some keen acro-modeller off in this direction.

The Flying Wing

I have recently built and flown an 8 ft. 10 in. span tail-less model, driven by a 2-c.c. "Majesco" diesel

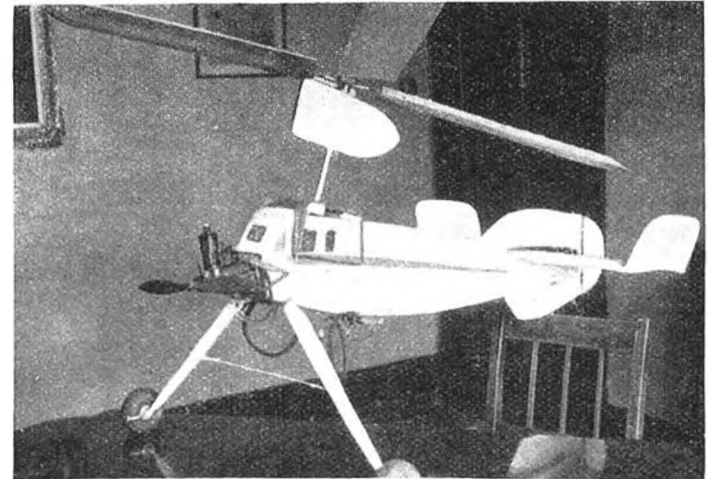

Fig. 121. The author's second petrol model autogiro that met with partial success. The rotor was mounted on a ball-bearing hub, and a fin below the rotor head was found to be necessary for lateral stability. The rotors were flexible at the hub, which is a necessity for successful stable flight.

engine pusher, thus emphasising the fact that the elimination of a fuselage and tail unit reduces drag and can therefore be flown by far less power. The German "Leipzig" down-turned wing tips increased lateral stability and enabled me to dispense with the usual

wing-tip rudders for directional stability. (See Fig. 123.)

Flaps

I am convinced that a great deal of useful work might be done in connection with petrol model wings being fitted with flaps in conjunction with slots. Really very slow flying models can be produced.

Brigadier Parham has produced a fully-flapped model that flew quite well. He formed his wing in three sections,

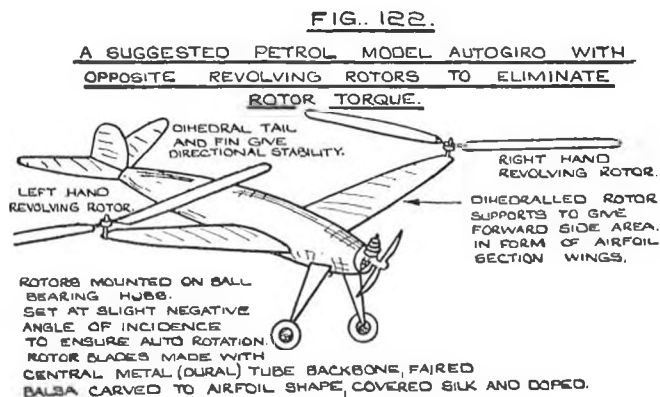

i.e., there were two slots. He found that with these slotted slats forming the wing it was possible to use a much smaller wing to carry the weight of the model.

I have experimented extensively with slots, and am still doing so. Some of my experiences are described elsewhere in this book in connection with wing-tip slots to help lateral stability. There is little doubt that slots, flaps and slats will eventually make the fast commercial full-sized machine land slowly and fly slowly in bad weather and poor visibility. It is a field for model experiment.

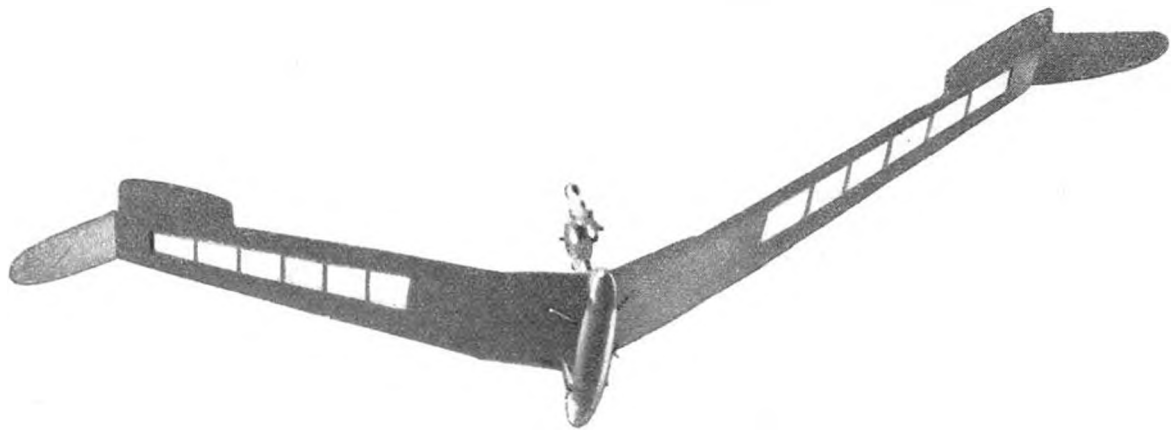
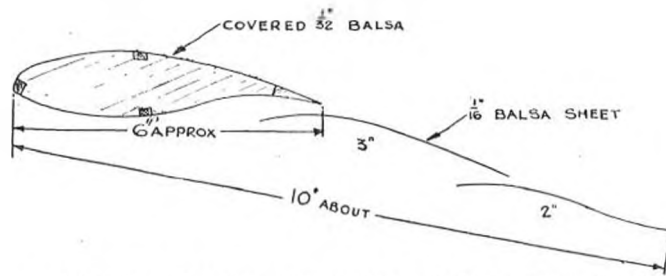

Fig. 123. The author's experimental tail-less model of 8 ft. 10 in. span is here seen flying, and powered by a 2-c.c. "Majesco" diesel engine. This model has wing-tip slots and "elerons" with slots. "Lipish" down-turned wing tips assist in lateral stability and act as rudders. The model is a stable flying machine.

FIG 124

BRIGADIER J. PARHAM'S SLATTED WING AS FITTED
TO HIS SUCCESSFUL PETROL MODEL



BIRD'S WING SECTION WITH SLOTS IS REASONABLY STABLE AND GIVES TERRIFIC LIFT, DRAG NOT AS BAD AS WOULD BE EXPECTED. PERMITS VERY LOW ASPECT RATIO $4\frac{1}{2}$ TO 1 EACH INDIVIDUAL SLAT IS OF HIGH ASPECT RATIO.

Aerial Photography

A great deal of amusement can be obtained by fitting a camera into a large petrol model. I have obtained some bird's-eye views of myself, spectators and other models sitting on the flying field in this way. A Kodak self-timer was used to operate the camera when the model had climbed about 50 ft. high and was circling around the

Fig. 125. A slab-sided 8-ft. span low-wing model of the author's flying.

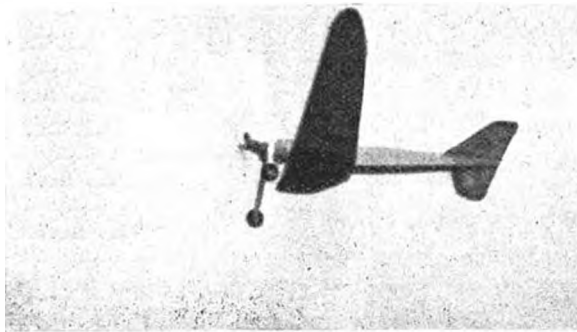

starting point. A dead calm day is required in order to keep the model over the target. Wind naturally causes the model to drift away in its circles.

Low-wing Petrol Models

The low-wing model has been considered a difficult type of petrol model and is almost unheard of in America. Actually, it flies extremely well if properly designed, and I feel that readers will gain a great deal of interesting



Fig. 126. Dr. Forster's scale model low-wing "Spitfire" fighter, of "Battle of Britain" fame.

experience if they experiment with low-wing design. Some of my most successful flying models have been low wings, and a low-wing model won the International Petrol Trophy in 1939 (The Bowden International Trophy presented by the author for yearly contest).

To prove there is no snag, I am including a flying photograph of one of my simple 8-ft. span low-wing models. See Fig. 125. This model has done a very great deal of flying without damage.

Dr. Forster has gone even further. He has built a scale model of a "Spitfire" fighter. I have seen this ingenious model flying, and plans can be bought. See Fig. 126. This model is fitted with his engine extension shaft and knock-off nose-piece to save propeller damage.

CHAPTER XVI

AUTHOR'S NOTE

[DURING the year 1936, I met Mr. Jeffries, author of the following chapter, who was then in his early days of interest in petrol model aircraft, and, as a result of our friendship, he built a design of mine with which he won the Sir John Shelley Power Cup in 1936.

After that, he launched out on his own with interesting models of excellent performance. Having an unusually good knowledge of radio matters, his experiments eventually led to radio control of his petrol models. He is one of the very few acro-modellers in this country who up to the time of writing this book have actually and genuinely flown a radio-controlled model with success.

During this war, Mr. Jeffries has been engaged on a large wireless-controlled model for official research work, and I am indebted to his firm, Messrs. Imber Research Ltd., of Aladdin's Buildings, Greenford, Middlesex, for their kind permission in allowing certain details connected with this work to be published.

As a result, we acro-modellists have some most valuable information and practical suggestions on which to base our radio control experiments straight from the horse's mouth!

Mr. Jeffries suggests that a simple model should be used at the beginning of any experiments. This is a point that I have laboured throughout this book in connection with all experimental models, and, in fact, all first models.]

RADIO CONTROL OF MODEL AIRCRAFT

BY C. R. JEFFRIES

It is surely the ambition of every petrol modeller to aspire to control his aircraft by radio. The problem of radio control is not new ; in fact, it was successfully done over 25 years ago, but the primitive equipment, with its spark transmitters and coherer receivers, has no place in the modern ether, firstly because of the appalling interference it would cause, the excessive weight and limited sensitivity and, above all, the unreliability of such a scheme.

Fortunately, the modern trend of design in recent years has been to produce a range of midget components of high efficiency. This, coupled with modern ultra-high-frequency transmitting technique, makes it possible to get adequate performance from a single valve receiver, superior to that given by three or four valves only a few years ago. The system I shall describe is built round a special valve developed particularly for radio control work on high frequencies by the Raytheon Corporation of America, and I can say from personal experience that the system will work without undue technical difficulties.

Before going into this system, I would strongly advise any modeller without considerable radio experience to contact a local radio transmitting enthusiast and get his co-operation. I say this, firstly, because transmitting licences before the war were only issued to persons who satisfied the G.P.O. of their technical skill and, no doubt,

after the war, with the many additional transmitters at work, the regulations will be even more stringently tightened. Secondly, the design and operation of a suitable ultra-high-frequency transmitter is, in itself, enough of a problem.

The Aircraft

It is not within the scope of this chapter to detail a design for an aircraft suitable for control by radio. The various points of design are fully covered in their particular chapters. A few recommendations might, however, prove helpful. In the first place, don't be too ambitious. A perfect scale model of some full-sized aircraft flying under complete control is the ambition of all, but less disappointment will be experienced if an aircraft of simple lines, of super stability and of rugged yet light construction is attempted first.

Assuming that an engine of the 10-c.c. class is used, a model of about 8 ft. span, with a flying weight, less radio,

FIG 127

SUGGESTED CIRCUIT FOR 56 MEGACYCLE CRYSTAL
CONTROLLED RADIO TRANSMITTER

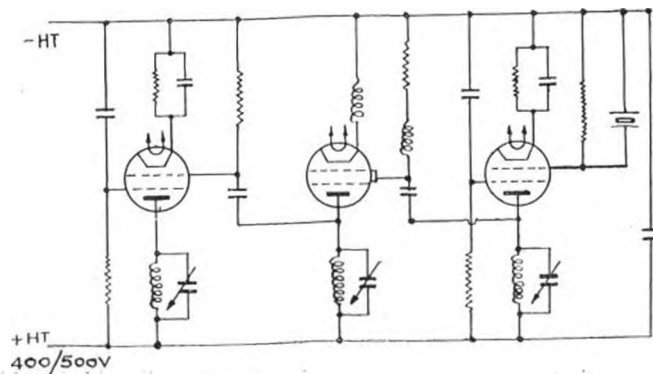
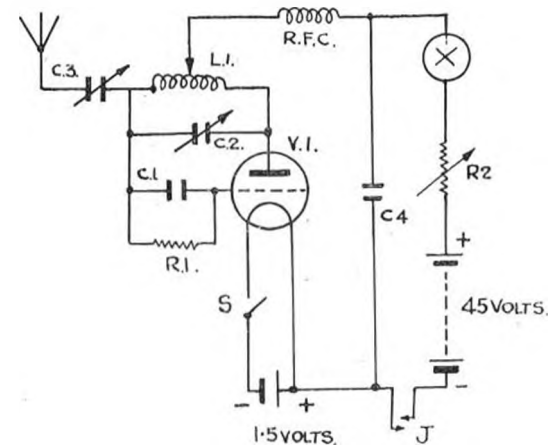

FIG. 128.

CIRCUIT FOR RECEIVER USING GAS
FILLED THYATRON VALVE.



VALUES OF COMPONENTS.

- C1 0001 MFD MICA CONDENSER.
- C2 .000025 MFD MIDGET VARIABLE CONDENSER.
- C3 TWO RATES $\frac{3}{4}$ SQ. SPACED $\frac{1}{8}$ APART.
- C4 .01 MFD MICA (THIS VALVE MAY REQUIRE VARYING.)
- R1 2 MEG OHM RESISTANCE.
- R2 15,000 OHM VARIABLE RESISTANCE.
- L1 6 TURNS 14 SWG COPPER WIRE $\frac{3}{8}$ " DIA
SPACED AT 1" CENTRES.
- R.F.C. SINGLE LAYER 36 SWG ENAMEL WIRE $\frac{1}{4}$ " DIA \times $\frac{1}{4}$ " LONG
- V1 RAYTHEON RK 62 VALVE.
- S ON OFF SWITCH.
- J JACK FOR MILLIAMPMETER.
- X RELAY 8,000 OHM COIL SINGLE POLE
CHANGE OVER CONTACTS.

of 5 to 6 lb., should have sufficient payload to carry this extra gear. The aircraft should be test-flown without radio first.

The Transmitter

For any reader who has the ability to produce a transmitter and feels inclined to tackle the whole job, a suitable circuit for a transmitter is given in Fig. 127. No values of components are given, as these are likely to vary with components and layout. It is essential that the transmitter is crystal-controlled and, when radiating on 56 megacycles (5.4 meters), should have a radio frequency output of some 8 to 10 watts fed into an efficient non-directional aerial. The whole transmitter should be designed to work from accumulators and employ either a vibrator or rotary generator giving at least 30 watts at 400 to 500 volts for the high-tension supply. The keying system will be described when dealing with the control gear.

The Receiver

As mentioned previously, the receiver was developed by the Raytheon Corporation and uses a type RK62 valve. This valve was obtainable in this country before the war at 25s. each. It is a miniature thyatron triode valve filled with an inert gas.

The circuit of this receiver is shown in Fig. 128 and should be adhered to exactly. The values of the various components are given and preference should be given to the smallest size resistors, condensers, etc. The valve, when operating correctly, gives an anode current change from 1.0 milliampere with no signal to 0.1 milliampere on receipt of a c.w. signal. This is ample to operate a sensitive relay.

For some time I used a miniature relay taken from an obsolete Fultograph still picture receiver which weighs barely $1\frac{1}{2}$ ozs. A more satisfactory relay is the Sigma

Type 3A with an 8,000-ohm coil, although the weight is somewhat heavier. The R.K.62 valve is very economical in its battery requirements. A single $1\frac{1}{2}$ -volt penlight cell will light the filament for several hours, and the smallest size 45-volt deaf and high-tension battery will give months of service.

In assembling the receiver, some thought should be given to the positioning of the various components, so that the wiring is reduced to the absolute minimum. I recommend that the receiver and relay is built as one unit and so designed as to be fitted into the aircraft near the centre of gravity and arranged so that the controls can be reached without the aircraft having to be dismantled. It will help if the receiver is mounted on sorbo rubber to damp out engine vibration and landing shocks. The batteries should be in a separate box located on runners and arranged so that they may be moved to adjust the centre of gravity.

Reverting to the layout of the receiver, use a good low-loss valve holder of the standard American 4-pin layout, or, better still, fit the valve with a non-metallic clamp round its base and solder the connections direct to its pins. Keep the wiring of the coil, variable condenser, grid leak and condenser as short as possible. Using the smallest batteries obtainable, the weight of this receiver can be got under 1 lb. Test out the receiver away from the aircraft first. A good low-reading milliammeter is essential: one about 1.5 or 2 milliamp full-scale deflection is suitable. This need not add to the flying weight, as it may be plugged in the jack while tuning and removed prior to flying.

The aerial is just a piece of flexible wire, about 4 ft. long, running from a short mast above the centre section to a point at the top of the fin. A rubber band at each end forms a suitable insulator and keeps the aerial taut and prevents whip. See Figs. 129 and 130.

Control Gear

So far, we have a transmitter and a receiver. Operation of the transmitter closes the contacts of the relay on the receiver. It is now necessary to use the relay as a switch to control whatever work we require done. There are

FIG 129
SUITABLE AERIAL FOR AIRCRAFT

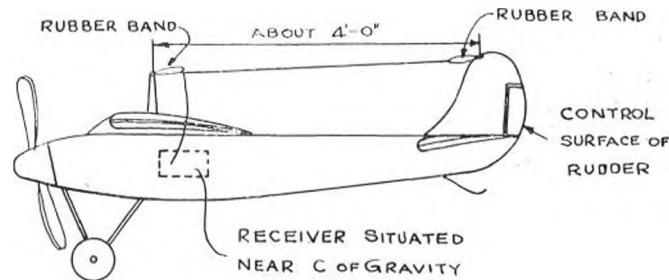

many varied systems, but, for a start, I recommend a simple sequence selector to give left, centre or right rudder. This was developed by Ross Hull, of America, and was used by Walter Good when he won the National Radio Control Contest of America two years running. It consists of a rubber-driven escapement that is tripped one revolution at a time by an electro magnet which is switched on by the closing of the contacts in our relay. This escapement is geared 4 to 1 to a second shaft which has a crank and link which moves what is really a rudder bar. This rudder bar is connected by cables (fishing line with a tension spring to keep it tight is excellent) and, if necessary, round pulleys to the rudder surface. Figure 131 gives the scheme. The actual rudder surface should be about 10 per cent. of the total area of the fin, and the amount of movement of the rudder should be adjustable. About $\frac{1}{4}$ in. each way should be tried for a start.

It will be seen that every time the relay of the receiver closes, a current will energise the electro-magnet in the escapement. The escapement will move one revolution. The second shaft will move $\frac{1}{4}$ revolution and will move the rudder bar from, say, left to centre, centre to right or right back to centre, and so on, in sequence. This may seem a disadvantage for, supposing the rudder is central and we want left rudder, three pulses will have to be transmitted to get right, centre and then left. Actually, the delay will only be about 1 sec. Figure 132 gives the

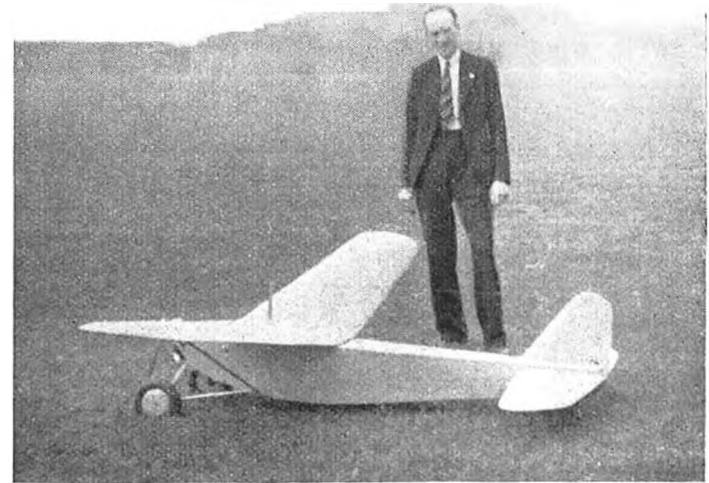

Fig. 130. The special war-time experimental model mentioned by Mr. Jeffries, weighing nearly 30 lb.

wiring from the receiver to the escapement electro-magnet. The switch must always be in the "off" position until after the receiver is turned on, and should be turned off again before the receiver, otherwise, when the receiver is turned off, the armature of the relay will close the contacts

and the selector magnet will be left energised and will rapidly run down the batteries.

The Transmitter Control Gear

The simplest possible arrangement is a push-button or key which, every time it is operated, sends a pulse which, in turn, operates the sequence in the aircraft one step. The big disadvantage in this, however, is that one has to remember which way the rudder moved last time. For

FIG 131
SCHEME FOR RUBBER DRIVEN ESCAPMENT
NOT TO SCALE.

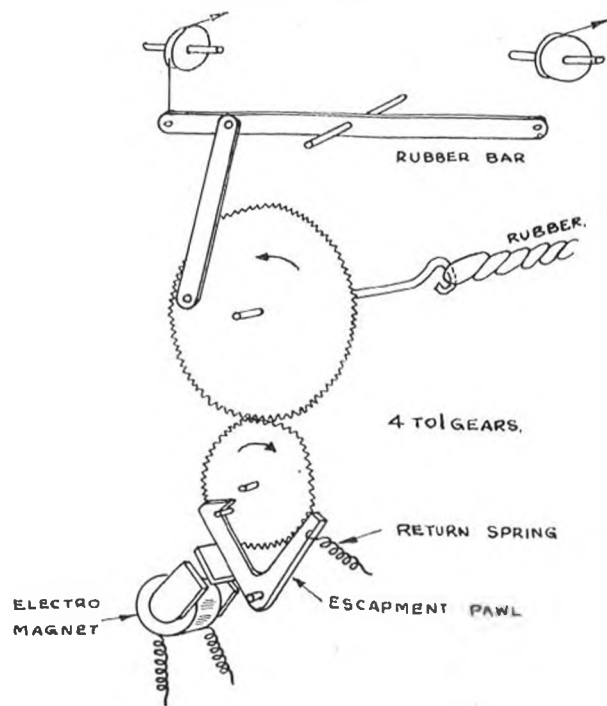
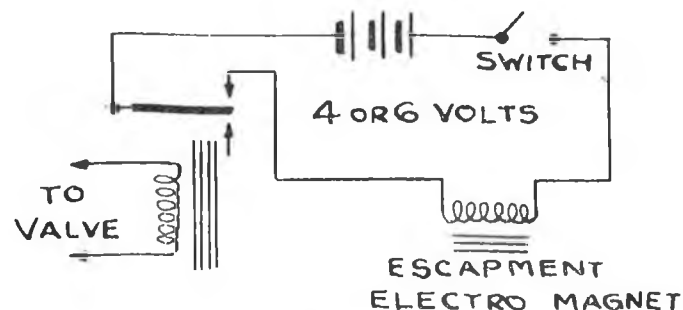

FIG 132
WIRING FOR ESCAPMENT.



instance, if the aircraft flying straight, to get, say, left rudder, is it one push or three? A simple method of overcoming this is to make a device so that, when a pointer is moved through one revolution, it makes an

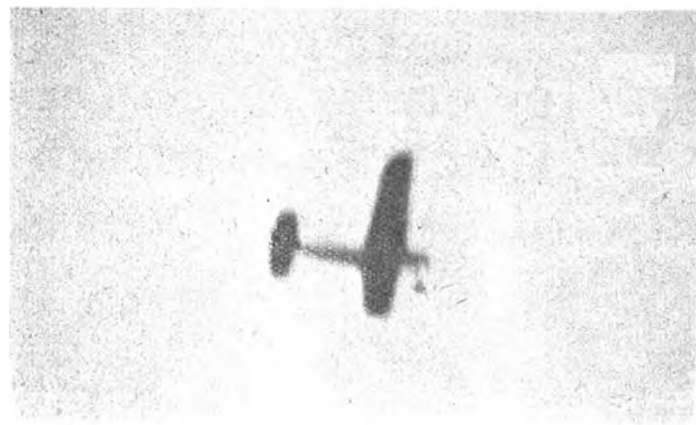

Fig. 133. The radio-controlled model seen in flight. The model is 10-ft. span and has made many flights of over 30 minutes.

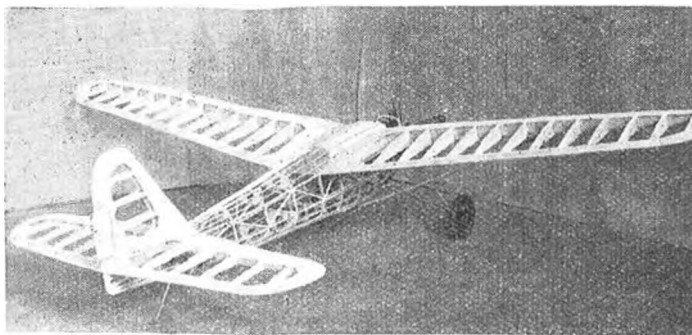

Fig. 134. One of Mr. Jeffries' radio-controlled models before covering with silk. Note the simple methods of construction and tail on the lines advocated by the author of this book.

electrical contact every quarter turn. Label the intermediate positions "left," "centre," "right," "centre," to agree with the sequence in the aircraft. A ratchet

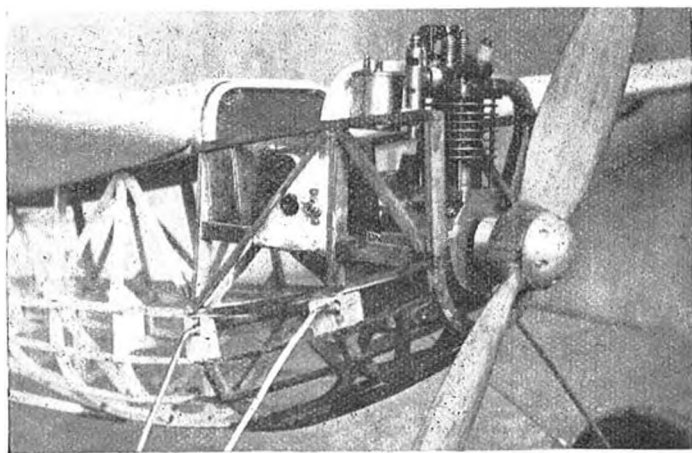

Fig. 135. An interesting view of the four-stroke o.h.v. single-cylinder engine used. A rigid mounting can be employed, as radio control helps to eliminate the danger of flying into obstacles.

must be fitted so that it is only possible to turn it in the correct direction. It will be seen that, moving from left to centre, for example, only one pulse will be sent, but moving from centre back to left, three pulses will be sent. The aircraft selector keeps in step the whole time. A more ambitious scheme will be a proper joy-stick with pawls so arranged that it may move from left to centre and then cannot move back to left until it has been



Fig. 135A. The author hand launching the small monocoque petrol model shown in Fig. 51A, on page 110.

moved to right. At each intermediate position electrical contacts will be made which will operate the transmitter.

In conclusion, I would state that the system described has been well tested, both in America and here, and I can say from personal experience that it is the system most likely to give the amateur immediate success. When experience has been gained on this comparatively simple equipment, a more ambitious design may be attempted

to give control of elevators, throttles, flaps, etc., in addition to the rudder.

The photographs show an aircraft belonging to Messrs. Imber Research Limited, of Greenford, which I developed for them. It is 10 ft. span, powered by a 1¼-h.p. engine and weighs nearly 30 lb., including over 6 lb. of radio gear. It has controls for engine in addition to rudder and has made many flights of half an hour or more under complete control throughout, and has been landed within feet of the point from which it took off.

CHAPTER XVII

FLYING A PETROL MODEL

Flying the Model

MUCH has been written with regard to flying a petrol model. Individuals of experience have their own pet methods and obtain first-class results. Competition work requires a special technique of its own to comply with the rules. There are, however, certain fundamentals that I have found out through the experience of many flying hours since the early days of the petrol model, and these will save the newcomer a lot of damage and disappointment. I therefore propose to explain my methods in broad outline. The finer points will come as the aeromodellist gains experience. No doubt he will also develop his own pet methods.

For the newcomer to petrol model flying, the initial tuning-up flights are the vital ones. It is essential that a sound procedure should be adopted if an expensive model is to survive. Far too many people launch their new petrol model under power for its first test flight in the air. They may, perhaps, obtain good flying results whilst the engine is running, and their spirits soar with the model, until the flight timer cuts the ignition. Then the model dives to earth too steeply or it noses up in a series of stalls and dives. The reason for this is that the owner has failed to appreciate *the vital fact that the model must first be adjusted to glide perfectly.*

Once the model has been got into perfect gliding trim, by hand launching and adjusting the centre of gravity, and the mainplane and tail incidences, so that the model is slightly nose-heavy and has a long flat glide and easy landing—*these adjustments must be left untouched.*

A model should be hand launched rather like throwing a dart. See Fig. 135A. The model must be thrown *dead into wind* (a slight wind is the best) and the nose must be slightly downwards at the model's anticipated gliding angle. It is necessary to judge the safest and approximate gliding speed of the model and to throw it forward at this speed. To launch too fast or too slowly will give false data.

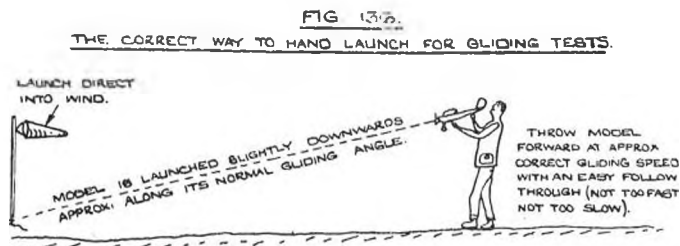

If the model is a high-wing or parasol, the thrust line will be below the centre of resistance. See Fig. 137.

The engine thrust will in this case tend to nose the model up and around the centre of resistance. If we have obtained perfect gliding with this type of model first and then left these gliding adjustments, all we have to do is to give the correct amount of downthrust to counteract the "nose up" tendency under power, i.e. the engine must point slightly downwards. A parasol, or high-wing model, should be adjusted for the glide with as little angle of incidence on the mainplane as is compatible with good lift and a long flat glide.

It is advisable for normal flying not to make maximum use of lift by flying at a large angle of incidence of the mainplane. A long, flat glide is what we usually require. I have sometimes purposely flown in certain competitions with a very large angle of incidence. I did this because I wanted to obtain a quick take-off and a quick sinking glide to earth to keep within the time allowance allotted.

If the model is a low-wing, then the thrust can be arranged to pass through the centre of resistance, and no downthrust will be required. In some cases of low-powered engines a shade of upthrust will be necessary.

Some people like to have a certain amount of turn on their models for the glide, as they argue that the model will keep in a smaller area. But personally I always see that my gliding tests ensure a straight glide *with no turn*, so that when the power ceases the model will glide straight. This ensures that the model will *land with its wings level*. If a petrol model glides with a turn, the inner wing will be flying low (because of the bank created by the turn) and as the model lands it often happens that the lower wing tip touches the ground, thus causing a nasty cartwheel crash. We will therefore adjust our model to *glide straight and we will not alter these adjustments*.

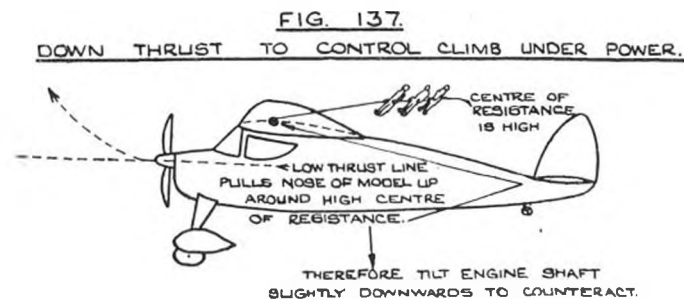

The torque of the airscrew under power will make the model bank and turn, so we give the engine sufficient offset of thrust-line, i.e. tilt the engine shaft slightly away from the torque reaction, so that the model turns in pleasant, easily controlled circles *only whilst the engine is running*. In other words, we allow the torque to turn the model easily, but not too much, by the use of offset of thrust-line. See Fig. 138.

When adjusting the offset of thrust to absorb torque, it is advisable to give the first flight only third throttle for a few seconds. Observation of the model's action can then be made. This flight can be followed by a half throttle flight with a little offset. Finally, a short three-quarter to full-throttle flight, when final adjustments can be made if necessary. After this, the long flights can take place.

If the detachable type knock-off engine mounting (as described in Chapter III) is used, it is a simple matter to alter adjustments to the downthrust and offset of thrust-line by adding packed slips of wood between mount and fuselage. When correct, these can be glued and covered with silk and finally doped as a permanent feature.

If the above procedure is followed, the model, when under power, will climb reasonably (controlled by sufficient downthrust to control over-climbing), and will turn reasonably (controlled by sufficient offset of thrust), and when the engine is stopped the model will glide to earth with both wings level, and a delightful landing will be made *because the model has first been adjusted as a perfect glider.*

It sounds simple, and it *is* simple! It is the secret of regular, no-damage flying, provided the model has been designed and constructed properly and, provided the weather is reasonable, so that the model does not land with excessive drift across a high wind. A beginner should not fly in a high wind. An "expert" takes a chance if he does.

It is a good plan when rise-off-ground flights are being carried out to let the model take-off slightly to the right of the wind, assuming that the propeller torque tends to turn the model to the left. Most model engines run so that the torque reacts to the left, looking from the tail to the nose of the machine.

To Summarise

1. Adjust your model to glide perfectly and straight and leave these adjustments.
2. Adjust the downthrust and offset of thrust so that the model climbs at a safe angle and turns in easy circles under three-quarter throttle.

Secure Adjustment Packings

When packings of wood have been added during the test flying period, to make adjustments to angles of incidence of mainplane or tail, downthrust or offset of thrust,

FIG 138

OFFSET OF THRUST LINE TO CONTROL TURN UNDER POWER

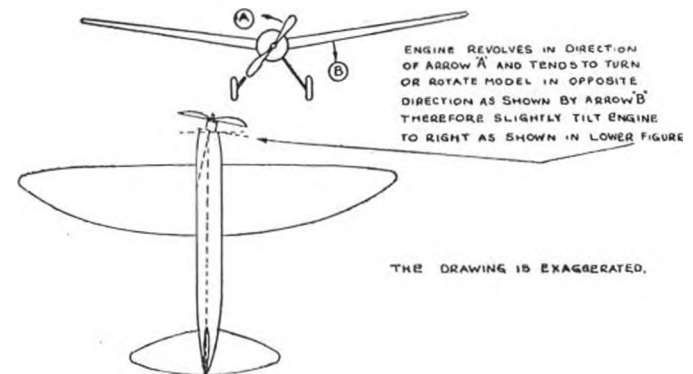

and these adjustments are complete, be careful to cover these packings with silk and dope the silk. Packings cannot then become unglued and lost.

Perhaps a little story will drive home this fact. In the early days of petrol flying I had several times succeeded in winning the Sir John Shelley Power Cup. I entered for this trophy in my last year in England before leaving for a tour of duty at Gibraltar. As usual, I thoroughly test-flew a trusty old model so that the engine and model

were in perfect trim to compete with the rules. On the great day I therefore was able to relax before the contest, look at the other competitors' models, chat and take photographs.

To my horror, when my time came to take off, the hitherto faithful old model leapt into the air in its normal manner, but began violently to stall, recover and stall again, thus upsetting all my time calculations. After the first of the three flights allowed, I looked the model over for warped wings, as I thought I knew that everything else was correct and in position. No signs of warps, broken longerons or anything else were in evidence, and my next flight came along. The same happened, and once again on the final flight of the three. I was frankly mystified!

I had motored the model down to the contest about 150 miles in my car, and when I got back I turned up the little adjustment diary that I kept in those days for my competition models, and I checked over every item of its history. I found that there had been a $\frac{1}{8}$ -in. piece of balsa under the leading edge of the "lifting-type" tailplane. This had been glued, silk-covered and doped, but I found that the whole affair was absent. This had been the cause of the trouble that had lost me the chance of winning the competition and my careful competition methods had actually been the cause of letting me down at last!

Because I had been methodical and this very method had won me the previous competitions, as it does most people, I had naturally taken for granted that my method of covering with silk and doping had secured the adjustment packings and I did not even check these packings during my quick look over between flights. In fact, I had forgotten them, so secure did I consider them. Actually, this one had been knocked off completely during the car journey. The moral is, of course, to check up every

packing slip *and its fixing*, before competition flight. Take nothing for granted, however long you have been at the game.

Some Flying Faults and Their Reasons

This is a quick check that may help the reader to diagnose some of the main faults he observes during test flying the new model.

1. *Model flies erratically and tail wanders, i.e. slides from side to side* : Too small a fin.

2. *Model turns in too tight circles* : Check up that wing and tail surfaces are not warped ; check offset of thrust, which may be too severe or insufficient. A badly-designed propeller of unsuitable pitch will cause excessive engine torque, which will roll model over or require excessive offset of thrustline.

3. *During steep banks it is noticed model (a) drops nose and spirals to earth* : Fin too large.

(b) *Tail drops and nose appears to rise, resulting in a stall, followed by a spiral spin* : Fin too small.

4. *Model drops a wing in slight air disturbances and fails to recover* : May be due to wing set at too great an angle of incidence and a wing tip then stalls. Also may be due to too little dihedral angle or a combination of both these points. Wings with swept-back leading edges are prone to this vice.

5. (a) *Model flies well under power, but when engine stops it stalls, recovers and stalls, and repeats the motion* : Model has not been adjusted as a glider first and climb controlled by engine power and thrustline adjustment. *Cure* : Adjust as glider and control by correct downthrust.

(b) *Model flies well under power, but when the engine stops model dives* : Model has not been adjusted as a glider first. In this case the engine, due to thrustline position and direction, is pulling up the nose of a nose-heavy model. When power ceases it drops into a dive. *Cure* : Adjust

as glider first and control climb afterwards by engine thrustline and power.

6. *Model not steady in longitudinal stability*: May be too small tailplane, or angles too coarse between wing and tail, or even vice versa. Refer back to Fig. 30 (e) in Chapter V.

7. *Model turns violently when power ceases, sometimes in opposite direction to power flight, with the result that a bad landing is made with one wing low during circles on glide*: Model was not adjusted for straight glide with power off. The fin is set over or there are warped surfaces.

I feel I should qualify the procedure given on page 226 for the initial flights. There I say that the final flights may be full throttle. *If a model is overpowered, it is far better not to fly it on full throttle.* It is a better practice to run the engine at a speed that gives a good steady climb, and no more. If a model is flown faster than its designed comfortable speed it becomes unstable and tricky. Such flying is the sign of a novice.

HOW TO ESTIMATE WIND STRENGTH

<i>Calm</i>	No wind felt, smoke vertical	0 m.p.h.
	Wind just felt on face, leaves rustle, handkerchief moves limply	5 m.p.h.
<i>Light breeze</i>	Leaves and twigs in constant motion, handkerchief flaps	10 m.p.h.
<i>Fresh breeze</i>	Papers blow away, dust is raised, small branches move	15 m.p.h.
	Small trees in leaf sway	20 m.p.h.
<i>Strong breeze</i>	Large branches sway, telephone wires whistle	25 m.p.h.
<i>Moderate gale</i>	Inconvenience felt when walking against wind	30 m.p.h.